



TransPort PT900

Portable ultrasonic flow meter
for liquids

Quick-start guide

916-146 Rev. A January 2017

Contents

1.0	Registration	1
2.0	Getting Help	1
3.0	Safety Information.....	2
4.0	Unpacking the PT900 System.....	4
5.0	Charging the PT900 Transmitter and Tablet	6
6.0	Installing the PT900 Tablet APP.....	6
7.0	Mounting the PT900 Transmitter	9
8.0	Pairing the Tablet and Transmitter.....	9
9.0	Initial Programming.....	12
10.0	Installing the Transducers.....	23
11.0	Taking Measurements	24

1.0 Registration

Thank you for purchasing a TransPort® PT900 from Panametrics. Please register your product at <https://info.bakerhughesds.com/New-Product-Registration-LP.html> for product support such as the latest software/firmware upgrades, product information and special promotions.

2.0 Getting help

This Quick-Start Guide is intended to provided an overview of the basic steps needed to get your PT900 System up and running quickly. For more detailed guidance on any of the steps discussed here or how to use the advanced features and functions available with the PT900, the following resources are available:

- Full PT900 User’s Manual
- PT900 Android APP Online Help
- Panametrics Website
- Panametrics Representatives

3.0 Safety information

The PT900 system must be installed and operated in accordance with the information in this section.

3.1 Safety issues

WARNING!



It is the responsibility of the user to make sure all local, county, state and national codes, regulations, rules and laws related to safety and safe operating conditions are met for each installation.

WARNING!



It is the responsibility of the user to make sure the power, analog and digital cables meet the published cable specifications (see your User's Manual).

3.2 Installation requirements

WARNING!



The PT900 flow transmitter can measure the flow rate of many fluids, some of which are potentially hazardous. The use of proper safety practices must be emphasized.

WARNING!



Be sure to follow all applicable local safety codes and regulations for installing electrical equipment and working with hazardous fluids or flow conditions. Consult company safety personnel or local safety authorities to verify the safety of any procedure or practice.

ATTENTION EUROPEAN CUSTOMERS!



To meet CE Mark and UL Mark requirements, all PT900 cables must meet the published specifications (see the User's Manual).

CAUTION!



For CE compliance, the PT900 is classified as a battery-powered device, and it is not to be operated with the AC power adapter connected. To comply with CE certification, unplug the AC power adapter before operating the PT900.

4.0 Unpacking the PT900 system

Before removing the PT900 system from its carrying case (see the optional hard shell carrying case in Figure 1 on page 5), inspect the contents of the case carefully. Before discarding any of the packing materials, account for all components and documentation listed on the packing slip. If anything is missing or damaged, contact Panametrics Customer Care immediately for assistance.

Because the PT900 system may be ordered in many different configurations, the following packing list is shown only as a typical example:

1. Transducers (2)
2. Clamping Fixture
3. Transducer Cables
4. Transmitter
5. Tablet
6. Tablet Power Cord
7. SD Card
8. Case
9. PT900 Power Supply
10. OD Tape
11. Couplant
12. PT900 Mounting Strap w/Magnet
13. Temperature Transmitter
14. Thickness Gauge
15. Documentation

In addition to the standard components, the following optional components are available for use with the PT900 system:

- Energy kit with an RTD module and an RTD cable for connection to the PT900 transmitter
- An AIO cable with cabling box
- A DIO cable with cabling box
- A battery charger
- A transducer extension cable up to 100 ft long
- A 48" chain for the clamp-on fixture

4.0 Unpacking the PT900 system (cont.)

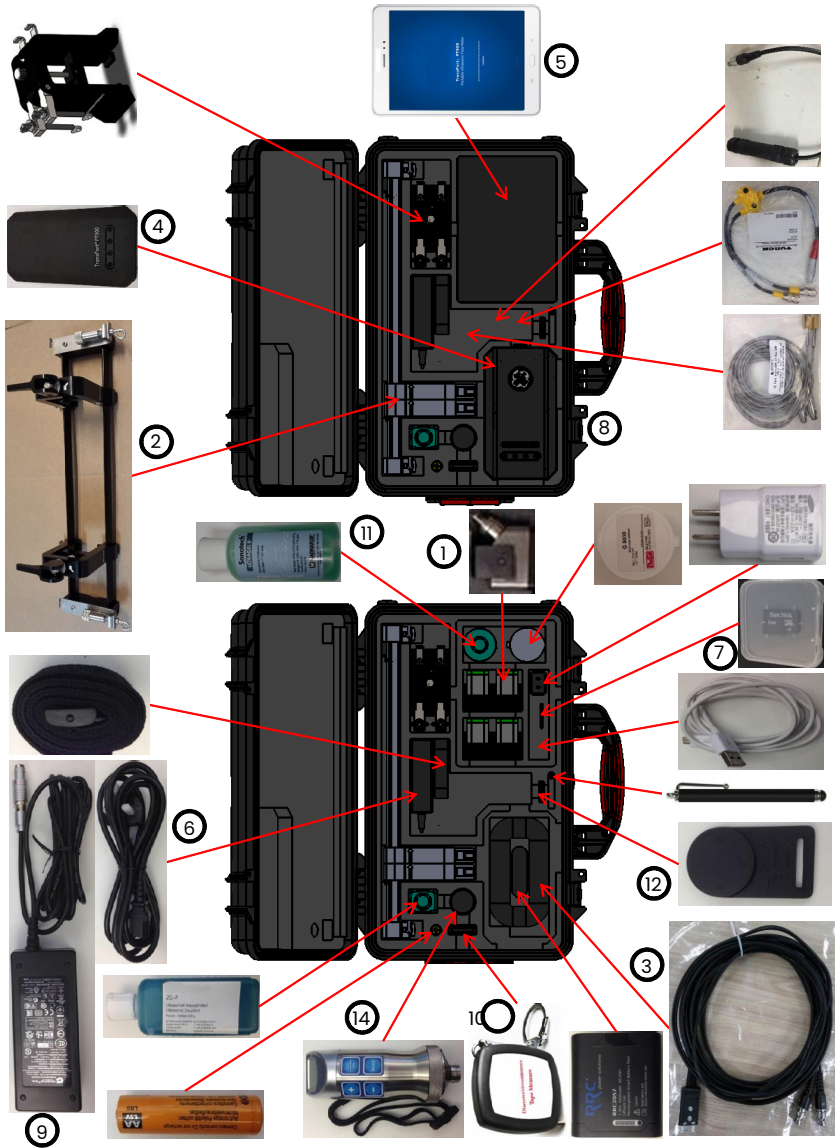

Figure 1: PT900 System in Hard Carrier Case

5.0 Charging the PT900 transmitter and tablet

Before proceeding, make sure that both the PT900 Transmitter and the Tablet are fully charged. The AC power adapter is shipped in the carry case. If either the transmitter or the tablet cannot be powered On after charging, contact your Panametrics representative for assistance.

To charge the transmitter, use the AC power adapter provided. Charging will occur whether the PT900 is On or Off, and the battery LEDs indicate the battery charging status. Charging a fully-depleted battery pack to full charge may take up to 3 hours.

6.0 Installing the PT900 tablet app

This section describes how to install the PT900 APP on your Android tablet.

6.1 Obtaining the PT900 android app

Obtain the PT900 APP from one of the following locations:

- Google Play Store (free download):

Set up a free account in Google Play Store. Search for the TransPort PT900 APP and install it on your tablet.

- QR Code or Panametrics Website (free download):

Either Scan the QR Code in Figure 2 below or download the latest version of the APP directly from the Panametrics website at the following URL: <https://www.bakerhughesds.com/panametrics/portable-flow-meters>



Figure 2: QR Code

- The SD card supplied with your PT900 system:

Plug the SD card directly into your tablet, and select the APK file from the SD folder.

Note: Check the Panametrics website for the latest version.

6.2 Installing the app on the tablet

To install the APP, complete the following steps:

1. Open the “My Files” folder on the tablet screen (see Figure 3 below) and select the APP from the SD folder.



Figure 3: The “My Files” Folder

2. If the APP is from an SD card or the Panametrics website, enable the security option in the tablet’s settings (see Figure 4 below) to allow the installation of software from “Unknown sources” for this installation only.

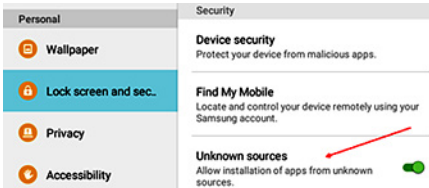

Figure 4: Security Settings

6.2 Installing the app on the tablet (cont.)

3. Click on the APK file, and the Android operating system will verify the checksum and signature for the file. Depending on whether this is an initial installation or an update installation, you will see a screen similar to Figure 5 below. Click “Install” to begin the installation.

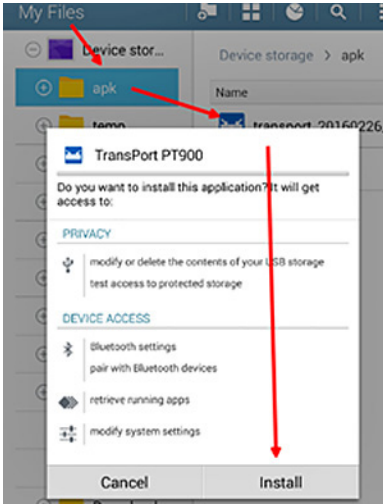

Figure 5: Initial Installation Screen

7.0 Mounting the PT900 transmitter

The PT900 portable transmitter is housed in a durable rubberized enclosure suitable for indoor or outdoor use. It can be placed in the optional hard shell carrier case, mounted on the pipe with the soft strap or mounted on the pipe with the magnet clamp (see Figure 6 below).

Note: The pipe temperature must be between -20°C and about $+40^{\circ}\text{C}$ to safely use the soft strap or magnetic clamp for mounting the transmitter.

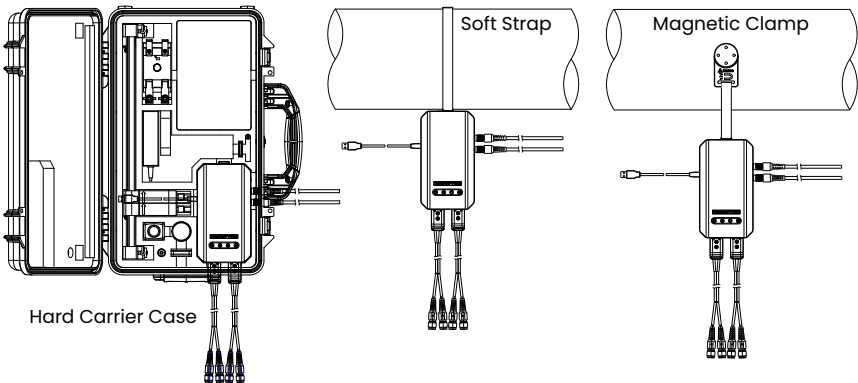

Figure 6: PT900 Transmitter Mounting Options

8.0 Pairing the tablet and transmitter

To pair the tablet and the transmitter via the wireless Bluetooth connection:

1. Make sure the Tablet is turned On, the PT900 APP is installed, and the battery is fully charged.
2. Make sure the Transmitter battery pack is fully charged, and turn the Transmitter On by pressing and holding the Pwr button for more than three seconds. The Green Power LED will indicate that the power is On.
3. After the APP finishes loading, the default Transmitter list is displayed. During initial installation, this list is empty. To connect to a new PT900 transmitter, click SCAN (see the red arrow in Figure 7 on page 10) and the APP will search for all available transmitters via Bluetooth.
4. After the scan has been completed, any new transmitters which were found are listed in the AVAILABLE DEVICES section of the tablet screen (see the red arrow in Figure 7 on page 10). Click on your transmitter to pair it with the tablet.

8.0 Pairing the tablet and the transmitter (cont.)

IMPORTANT

Although Bluetooth is installed in many devices, the PT900 APP is designed to filter out all devices except those with names of the form PT900-Mxxxxxxx.

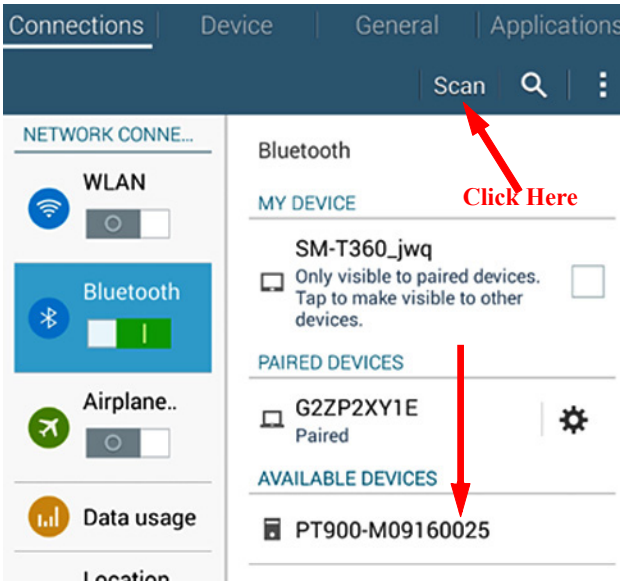

Figure 7: Available Devices List

Note: In the above step, your PT900 transmitter is identified by the serial number on its label (see Figure 8 below).



Figure 8: Transmitter Serial Number

8.0 Pairing the tablet and the transmitter (cont.)

- During the pairing process, PT900 security features require the user to confirm the pairing (see Figure 9 below). When the Bluetooth pairing request appears on the tablet, a random passkey will be generated. You may ignore the random passkey and click OK to continue. Then, confirm that the blue LED on the transmitter is flashing and click the transmitter power button.

IMPORTANT

The pairing is completed only after it is confirmed at both the tablet and the transmitter. Otherwise, the pairing will fail.



Figure 9: Confirm Pairing

- Click the BACK button (shown at right) on the Android tablet to return to the PT900 APP. Then, select your PT900 transmitter in the TRANSMITTERS PAIRED list and click NEXT to open the Main Menu.



9.0 Initial programming

9.1 Selecting the app language

When opening the Tablet APP for the first time, the screen in Figure 10 below is shown. Select the desired language for the APP and click OK.

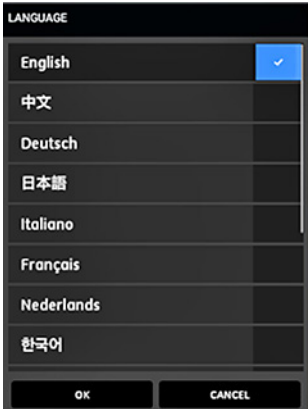

Figure 10: APP Language Options

9.2 Accepting the license agreement

The PT900 License Agreement screen (see Figure 11 below) is shown next. Read the agreement carefully and then click AGREE to continue with the APP installation or click CANCEL to stop the APP installation.



Figure 11: PT900 License Agreement

9.3 Registering the PT900

At the Registration screen (see Figure 12 below), click OK to register your PT900 or click CANCEL to skip the registration.

Note: If you skip the registration, the screen will popup as a reminder the first five times you launch the APP and then it will never appear again.

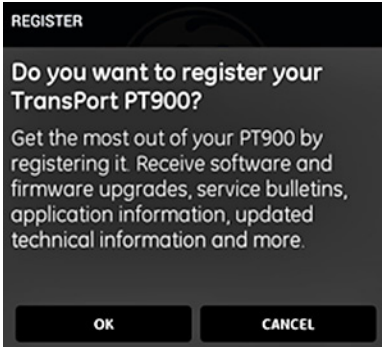

Figure 12: PT900 Registration

9.4 The app main menu

Note: As an alternative to the Main Menu described below, you may use the Slide Menu shown on the next page.

The main menu screen shown in Figure 13 below is the starting point for all PT900 programming steps. At a minimum, to get your PT900 system up and running to begin taking measurements, program the following menus:

- “Selecting the Units of Measurement” on page 16
- “Activating Channel 1” on page 17
- “Programming the PIPE Menu” on page 18
- “Programming the FLUID Menu” on page 19
- “Programming the TRANSDUCERS Menu” on page 20
- “Programming the PLACEMENT Menu” on page 21

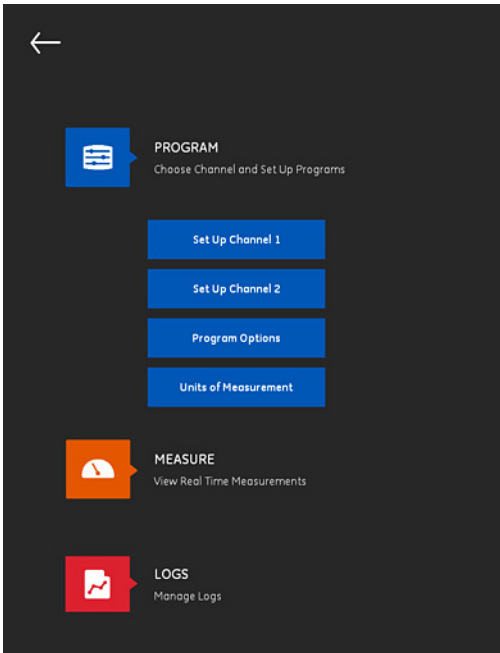

Figure 13: The APP Main Menu

9.5 The app slide menu

As an alternative to the Main Menu discussed in the previous section, you may use the Slide Menu shown in Figure 14 below.

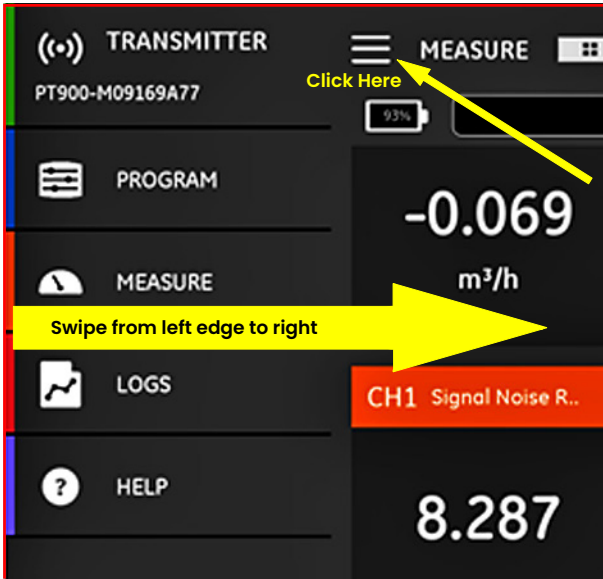

Figure 14: APP Slide Menu Screen

To access the Slide Menu, either click the  icon in the top left corner of the screen or swipe across the screen from the left edge to the right. The available options in the APP Slide Menu are:

- **PROGRAM**, which is used for selecting and configuring a channel.
- **MEASURE**, which is used for viewing real time measurements, error reports and diagnostics information.
- **LOGS**, which is used for setting up log files and managing logs stored in the PT900 transmitter.
- **HELP**, which is used for accessing detailed information and instructions for your PT900 system.

9.6 Selecting the units of measurement

Click the Units of Measurement button in Figure 13 on page 14 to open the UNIT OPTIONS menu shown in Figure 15 below. This menu allows the user to select the measurement units displayed by the PT900 in all of its display screens.

Note: Because the choice of Metric or English units is reflected in all other menu screens, this menu should be programmed first.

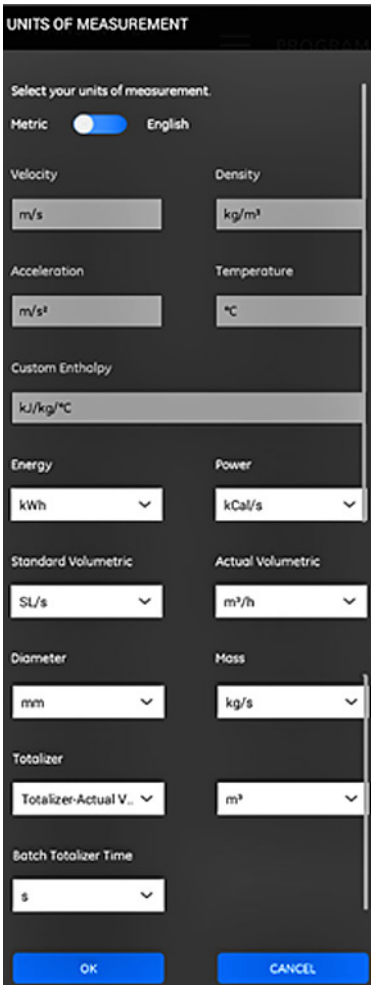

The screenshot shows a dark-themed menu titled "UNITS OF MEASUREMENT". At the top, it says "Select your units of measurement." Below this is a toggle switch for "Metric" (which is turned on) and "English". The menu contains several sections, each with a label and a dropdown menu:

- Velocity:** m/s
- Density:** kg/m³
- Acceleration:** m/s²
- Temperature:** °C
- Custom Enthalpy:** kJ/kg/°C
- Energy:** kWh
- Power:** kCal/s
- Standard Volumetric:** SL/s
- Actual Volumetric:** m³/h
- Diameter:** mm
- Mass:** kg/s
- Totalizer:** Totalizer-Actual V... (dropdown)
- Batch Totalizer Time:** s

At the bottom of the menu are two buttons: "OK" and "CANCEL".

Figure 15: The Units of Measurement Menu

9.6 Selecting the units of measurement (cont.)

To program the Units of Measurement options, complete the following steps:

1. Move the slide switch at the top of the menu to either Metric or English to select the desired PT900 global measurement units system.
2. Based on your selection above, the units for all of the PT900 measurement parameters will be automatically populated with default units.
 - a. Some of the parameters have only one units of measure choice available. The text boxes for these parameters are grayed out, and the default units cannot be changed.
 - b. Some of the parameters have multiple units of measure choices available. The text boxes for these parameters are active, and the default units can be changed by opening the drop-down list and selecting the desired units.
3. After you have completed your programming, click the OK button to save your choices or click the CANCEL button to discard the changes.

9.7 Activating Channel 1

Click the Setup Channel 1 button in Figure 13 on page 14 to open the Channel 1 menu shown in Figure 16 on page 18. At the top of the menu, slide the toggle switch to change the channel status from Off to On.

9.8 Programming the PIPE menu

Use the PIPE menu (see Figure 16 below) to specify all pipe parameters, to ensure accurate flow rate measurements. For each of the menu options, select an option from the drop-down list or enter the appropriate value for your site.

Note: Refer to your user's manual for detailed instructions on each option.

The screenshot displays the 'PROGRAM (ONLINE MODE)' interface for 'Channel 1'. At the top, there are 'COPY CH' and 'PRESETS' buttons, and a toggle switch for 'Channel 1' currently set to 'Off'. Below this is a navigation bar with 'PIPE', 'FLUID', 'TRANSDUCERS', and 'PLACEMENT' tabs. The 'PIPE' tab is active, showing the following settings:

- PIPE MATERIAL:** Steel (Carbon) (dropdown)
- PIPE SOUND SPEED:** 3230.0 m/s (text input)
- PIPE STANDARD:** ANSI (dropdown)
- NOMINAL:** 1/8 (dropdown)
- SCHEDULE:** 40 (dropdown)
- OUTER DIAMETER:** 10.287 mm (text input)
- WALL THICKNESS:** 1.727 mm (text input)
- LINING:** Yes (dropdown)
- LINING MATERIAL:** Other (dropdown)
- LINING SOUND SPEED:** 2000.0 m/s (text input)
- LINING THICKNESS:** 0.0 mm (text input)

Figure 16: Channel 1 – PIPE Menu

9.9 Programming the FLUID menu

Use the FLUID menu (see Figure 17 below) to specify all fluid parameters, to ensure accurate flow rate measurements. For each of the menu options, select an option from the drop-down list or enter the appropriate value for your site.

Note: Refer to your user's manual for detailed instructions on each option.

The screenshot shows the 'PROGRAM (ONLINE MODE)' interface. At the top, there is a hamburger menu icon, the text 'PROGRAM (ONLINE MODE)', and two buttons: 'COPY CH' and 'PRESETS'. Below this, 'Channel 1' is displayed with a toggle switch set to 'On'. A navigation bar contains four tabs: 'PIPE', 'FLUID' (which is highlighted with a blue underline), 'TRANSDUCERS', and 'PLACEMENT'. The 'FLUID' menu contains several settings:

- TRACKING WINDOW:** A toggle switch set to 'On'.
- MIN SOUND SPEED:** A text input field containing '300.0' with 'm/s' to its right.
- MAX SOUND SPEED:** A text input field containing '4000.0' with 'm/s' to its right.
- FLUID:** A dropdown menu showing 'Other' with a downward arrow.
- TEMPERATURE:** A text input field containing '25.0' with '°C' to its right.
- SOUND SPEED:** A text input field containing '1496.0' with 'm/s' to its right.
- GLYCOL IN WATER:** A text input field containing '0.0' with '%' to its right.
- KINEMATIC VISCOSITY:** A text input field containing '1.000' with 'cST' to its right.
- AVE FACTOR:** A text input field containing '1.0'.

Figure 17: Channel 1 - FLUID Menu

9.10 Programming the TRANSDUCERS menu

Use the TRANSDUCERS menu (see Figure 18 below) to specify all transducer parameters, to ensure accurate flow rate measurements. For each of the menu and sub-menu options, select an option from the drop-down list or enter the appropriate value for your site.

Note: Refer to your user's manual for detailed instructions on each option.

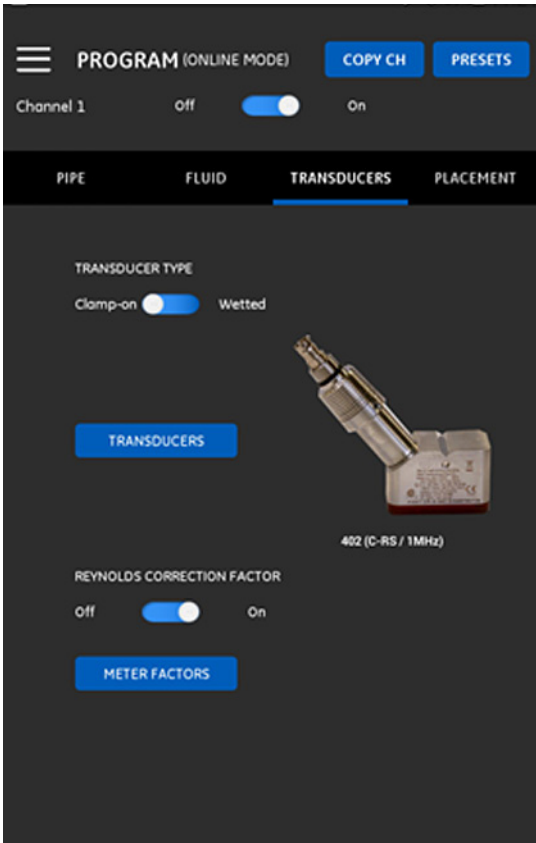

Figure 18: Channel 1 – TRANSDUCER Menu

9.11 Programming the PLACEMENT menu

The PLACEMENT menu allows the user to configure the mounting method of the transducers, based on the programmed information in the TRANSDUCERS menu (see “Programming the TRANSDUCERS Menu” on page 20).

9.11.1 Viewing the traverse configuration

For CLAMP-ON transducers, one of the six possible TRAVERSE configurations shown in Figure 19 below is displayed, as appropriate for your programmed transducer information. Typically, a two-traverse installation is used.

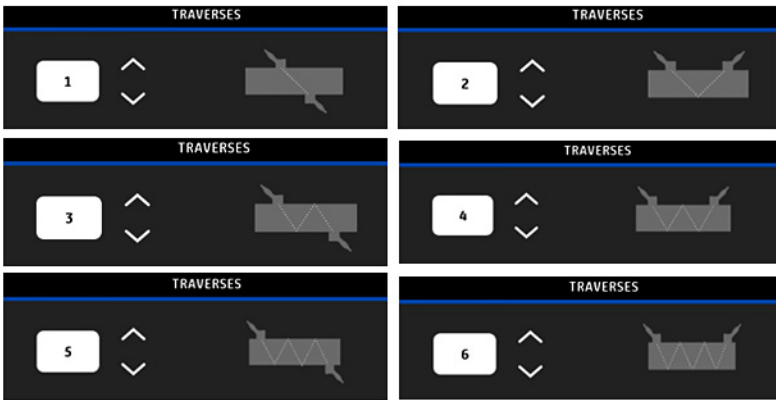

Figure 19: Clamp-On Traverse Configurations

9.11.2 Viewing the transducer spacing

The TRANSDUCER SPACING screen (see Figure 20 below) shows the value calculated by the PT900 for the correct distance between the upstream and downstream transducers, based on your programmed data. This value is used when installing your transducer clamping fixture on the pipe.

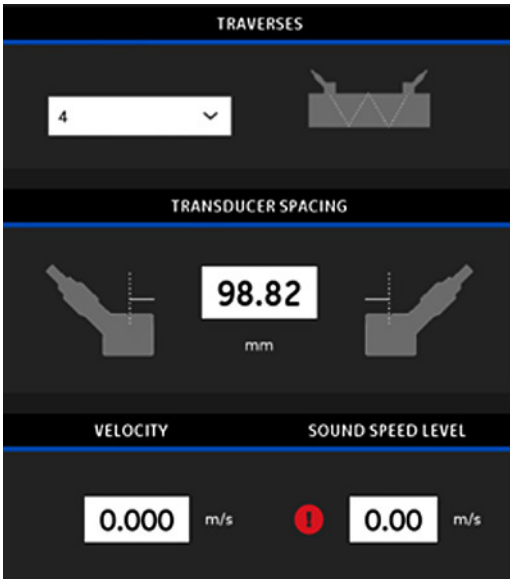

Figure 20: Transducer Spacing Value

10.0 Installing the transducers

To install the Transducers, complete the following steps:

1. Select a clamp-on fixture mounting location on the pipeline which meets the following requirements:
 - A straight pipe run of at least 10 nominal pipe diameters (with no fittings or bends) before the upstream transducer
 - A straight pipe run of at least 5 nominal pipe diameters (with no fittings or bends) after the downstream transducer
 - A clearance of at least 6" from the outer edge of each end piece to the nearest joint, welding or flange in the pipeline
2. Mount the Clamp-On Fixture on the pipe (not provided) in the selected location, and set the Transducer Spacing to the value calculated by the APP (see Figure 20 on page 22).
3. Mount the transducers into the clamp-on fixture.
4. Connect the transducers to the transmitter with the cables provided.

For reference, a completed PT900 installation is shown in Figure 21 below.

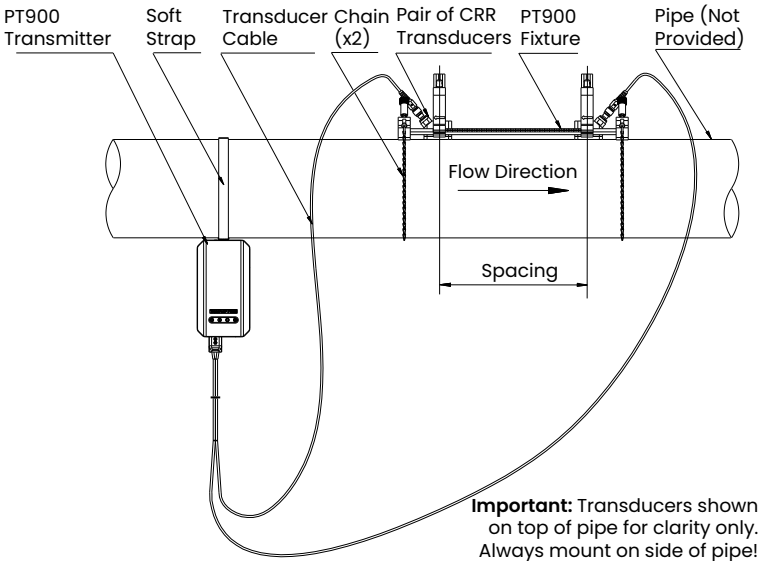

Figure 21: Completed Example Installation

11.0 Taking measurements

11.1 Setting up the measurements for display

The PT900 APP can display up to 10 different variables at the same time. To set up your display screen, click the EDIT button at the top right of the measurement screen to open the SET UP MEASUREMENTS menu, as shown in Figure 22 below.

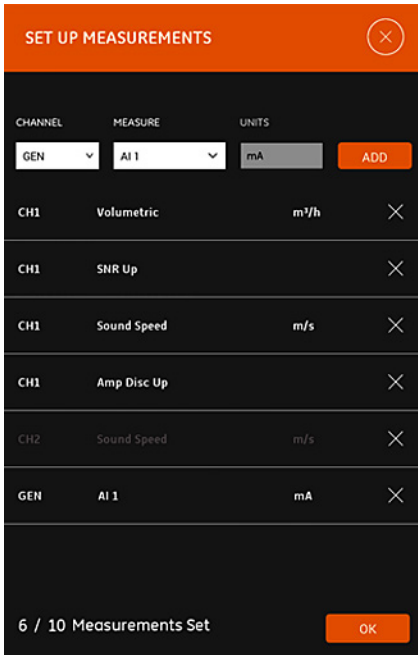

Figure 22: Set Up Measurements Menu

To set up your display measurements, complete the following steps:

1. Open the drop-down list in the CHANNEL box and select either CH1, CH2, Average or General as the channel to be displayed.
2. Open the drop-down list in the MEASURE box and select the desired measurement variable from the list.

11.2 Selecting the measurement screen

After configuring the flow rate measurements in the previous section, select either the multiple numeric, single numeric or graphical display screen option (see Figure 23 below).

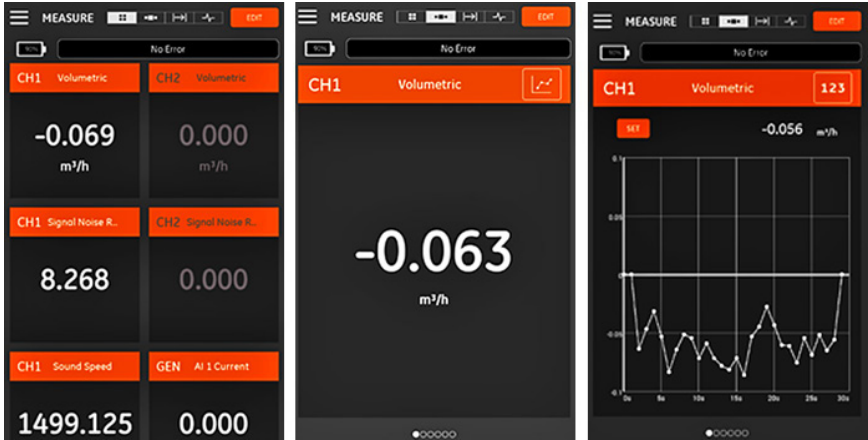

Figure 23: Measurement Screen Options

12.0 PT900 LED indicators

The four colored LEDs on the front of the PT900 transmitter (see Figure 24 below) provide real time information on the meter status. See the next page for details.

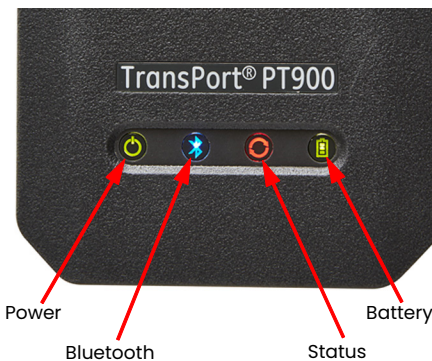

Figure 24: PT900 Transmitter LEDs

12.1 Power LED

- Solid Green light when the meter is powered On
- No light when the meter is Off
- Blinking Green light when the meter is in power save mode

12.2 Bluetooth LED

- Solid Blue light when Bluetooth® is linked to a transmitter
- Blinking Blue light when Bluetooth® is in the click-button to confirm pairing process
- Solid Red light when the meter is on and Bluetooth® is idle or is not linked to a transmitter
- No light when Bluetooth® is in configuration mode

12.3 Status LED

- Solid Green light when the meter is in measure mode without any errors
- Red light when an error occurs while the meter is in measure mode
- No light when the meter is in configure mode

12.4 Battery LED

- Solid Green light when the battery is fully charged ($>99\%$), but the AC adapter is connected
- Solid Green light when the battery level is high ($>20\%$), but the AC adapter is not connected
- Blinking Green light when the battery is not fully charged, but it is charging with the AC adapter connected
- Red light when the battery level is low ($\leq 20\%$) and the battery needs to be charged immediately
- Blinking Red light when the battery level is low ($\leq 10\%$) and the meter will be out of power soon
- Light off when the meter is On, but the battery is completely discharged and the AC adapter is connected

Customer support centers

Americas

U.S.A.

The Boston Center
1100 Technology Park Drive
Billerica, MA 01821
U.S.A.
Tel: +1 800 833 9438 (toll-free)
Tel: +1 978 437 1000
E-mail:
mstechsupport@bakerhughes.com

Europe

Ireland

Sensing House
Shannon Free Zone East
Shannon, County Clare
Ireland
Tel: +353 61 61470200
E-mail:
mstechsupport@bakerhughes.com

Panametrics, a Baker Hughes Business, provides solutions in the toughest applications and environments for moisture, oxygen, liquid and gas flow measurement. Experts in flare management, Panametrics technology also reduces flare emissions and optimizes performance.

With a reach that extends across the globe, Panametrics' critical measurement solutions and flare emissions management are enabling customers to drive efficiency and achieve carbon reduction targets across critical industries including: Oil & Gas; Energy; Healthcare; Water and Wastewater; Chemical Processing; Food & Beverage and many others.

Join the conversation and follow us on LinkedIn
[linkedin.com/company/panametricscompany](https://www.linkedin.com/company/panametricscompany)

Copyright 2021 Baker Hughes Company. All rights reserved.

916-146 Rev. A
BHCS39051

(06/2021)

Baker Hughes 

[panametrics.com](https://www.panametrics.com)