

THESE INSTRUCTIONS PROVIDE THE CUSTOMER/OPERATOR WITH IMPORTANT PROJECT-SPECIFIC REFERENCE INFORMATION IN ADDITION TO THE CUSTOMER/OPERATOR'S NORMAL OPERATION AND MAINTENANCE PROCEDURES. SINCE OPERATION AND MAINTENANCE PHILOSOPHIES VARY, BAKER HUGHES COMPANY (AND ITS SUBSIDIARIES AND AFFILIATES) DOES NOT ATTEMPT TO DICTATE SPECIFIC PROCEDURES, BUT TO PROVIDE BASIC LIMITATIONS AND REQUIREMENTS CREATED BY THE TYPE OF EQUIPMENT PROVIDED.

THESE INSTRUCTIONS ASSUME THAT OPERATORS ALREADY HAVE A GENERAL UNDERSTANDING OF THE REQUIREMENTS FOR SAFE OPERATION OF MECHANICAL AND ELECTRICAL EQUIPMENT IN POTENTIALLY HAZARDOUS ENVIRONMENTS. THEREFORE, THESE INSTRUCTIONS SHOULD BE INTERPRETED AND APPLIED IN CONJUNCTION WITH THE SAFETY RULES AND REGULATIONS APPLICABLE AT THE SITE AND THE PARTICULAR REQUIREMENTS FOR OPERATION OF OTHER EQUIPMENT AT THE SITE.

THESE INSTRUCTIONS DO NOT PURPORT TO COVER ALL DETAILS OR VARIATIONS IN EQUIPMENT NOR TO PROVIDE FOR EVERY POSSIBLE CONTINGENCY TO BE MET IN CONNECTION WITH INSTALLATION, OPERATION OR MAINTENANCE. SHOULD FURTHER INFORMATION BE DESIRED OR SHOULD PARTICULAR PROBLEMS ARISE WHICH ARE NOT COVERED SUFFICIENTLY FOR THE CUSTOMER/OPERATOR'S PURPOSES THE MATTER SHOULD BE REFERRED TO BAKER HUGHES.

THE RIGHTS, OBLIGATIONS AND LIABILITIES OF BAKER HUGHES AND THE CUSTOMER/OPERATOR ARE STRICTLY LIMITED TO THOSE EXPRESSLY PROVIDED IN THE CONTRACT RELATING TO THE SUPPLY OF THE EQUIPMENT. NO ADDITIONAL REPRESENTATIONS OR WARRANTIES BY BAKER HUGHES REGARDING THE EQUIPMENT OR ITS USE ARE GIVEN OR IMPLIED BY THE ISSUE OF THESE INSTRUCTIONS.

THESE INSTRUCTIONS ARE FURNISHED TO THE CUSTOMER/OPERATOR SOLELY TO ASSIST IN THE INSTALLATION, TESTING, OPERATION, AND/OR MAINTENANCE OF THE EQUIPMENT DESCRIBED. THIS DOCUMENT SHALL NOT BE REPRODUCED IN WHOLE OR IN PART WITHOUT THE WRITTEN APPROVAL OF BAKER HUGHES.

Conversion Table

All the USCS values are converted to metric values using the following conversion factors:

USCS Unit	Conversion Factor	Metric Unit
in.	25.4	mm
lb.	0.4535924	kg
in ²	6.4516	cm ²
ft ³ /min	0.02831685	m ³ /min
gal/min	3.785412	L/min
lb/hr	0.4535924	kg/hr
psig	0.06894757	barg
ft lb	1.3558181	Nm
°F	5/9 (°F-32)	°C

Note: Multiply USCS value with conversion factor to get metric value.

NOTICE!

For valve configurations not listed in this manual, please contact your local MARC™ (Masoneilan Authorised Repair Center) or Baker Hughes sales office for assistance.

Table Of Contents

1. Instrument Operation	1
2. Numbering System.....	1
3. Technical Specification	1
4. ATEX Intrinsic Safety Marking and Electrical Safety Parameters	2
5. ATEX Flameproof Marking and Electrical Safety Parameters	3
6. Position Transmitter 496-8../. Electrical data	4
7. Electrical Connection, Installation and Start-up.....	4
8. Calibration.....	6
9. Maintenance.....	9
10. Special Conditions of Work.....	9
11. Special Conditions of Use	11
Annex I: Intrinsic Safety Temperatures	13
Annex II: Flameproof Temperatures	15
Annex III: Cable Gland Accessories Mounting	17
Annex IV: Switch Configurations	19

Warning

BEFORE installing, using or carrying out any maintenance tasks associated with this instrument, READ THE INSTRUCTIONS CAREFULLY.

These instruments comply with the essential safety requirements of the European Directive ATEX 2014/34/EU. It is certified to be used in Gas or Dust explosive atmospheres, groups IIA, IIB, IIC and IIIC:

- Category II 1 GD, II 1 G or II 2 G – zones 0, 1, 2, 20, 21 and 22 for the protection mode “ia”
- Category II 2GD – zones 1, 2, 21 and 22 for the protection mode “db” and “tb”

They also comply with the essential safety requirements of the European Directive EMC 2014/30/EU as amended, for use within an industrial environment.

Products certified as **explosion proof equipment MUST BE:**

- a. Installed, put into service, used and maintained in compliance with European and/or national and local regulations and in accordance with the recommendations contained in the relevant standards concerning potentially explosive atmospheres.
- b. Used only in situations those comply with the certification conditions shown in this document and after verification of their compatibility with the zone of intended use and the permitted maximum ambient temperature.
- c. Installed, put into service and maintained by qualified and competent professionals who have undergone suitable training for instrumentation used in areas with potentially explosive atmosphere. Such trainings are not supported by Baker Hughes.

It is the end user's responsibility to:

- **Verify material compatibility with the application**
- **Ensure proper use of fall protection when working at heights, per Safe Site Work Practices**
- **Ensure use of proper Personal Protective Equipment**
- **Take the appropriate actions to ensure that site personnel who are performing installation, commissioning and maintenance have been trained in proper site procedures for working with and around equipment, per Safe Site Work Practices**

Baker Hughes reserves the right to discontinue manufacture of any product or change product materials, design, or specifications without notice.

1. Instrument Operation

1.1 The 496-.58 and 496-.57 position limit switch

Allow switching 1 or 2 electrical circuits. This function is provided by 1 or 2 micro-switch(es) or 1 or 2 proximity switch(es). This device can be mounted on both rotary and reciprocating valves.

1.2 The 496-857 and 496-857/. and 496-858 or 496-858/. position transmitter

The 496 Series instrument is a non-contact opto- electronic positioner transmitter which provides a 4-20mA analog output signal proportional to the valve position. This device can be both mounted on rotary and reciprocating valves.

The opto-electronic sensor has the same function than a standard potentiometer and its output voltage is proportional to the rotation of its axis.

An electronic circuit amplifies this voltage to a 4-20 mA signal proportional to the angle of rotation. This equipment has many advantages:

- Non-electrical noise typical of potentiometer with cursor
- Frictionless
- Unlimited life
- Non-sensitive to vibration and electrical noise
- Very low operating torque: 0.02 N.m

Optionally, 496-8xx/x apparatus can be used with additional functions as 1 or 2 micro-switch(es) or 1 or 2 proximity switch(es). This is also possible for type 496-1xx/x and type 496-2xx/x with the same type of switch.

2. Numbering System

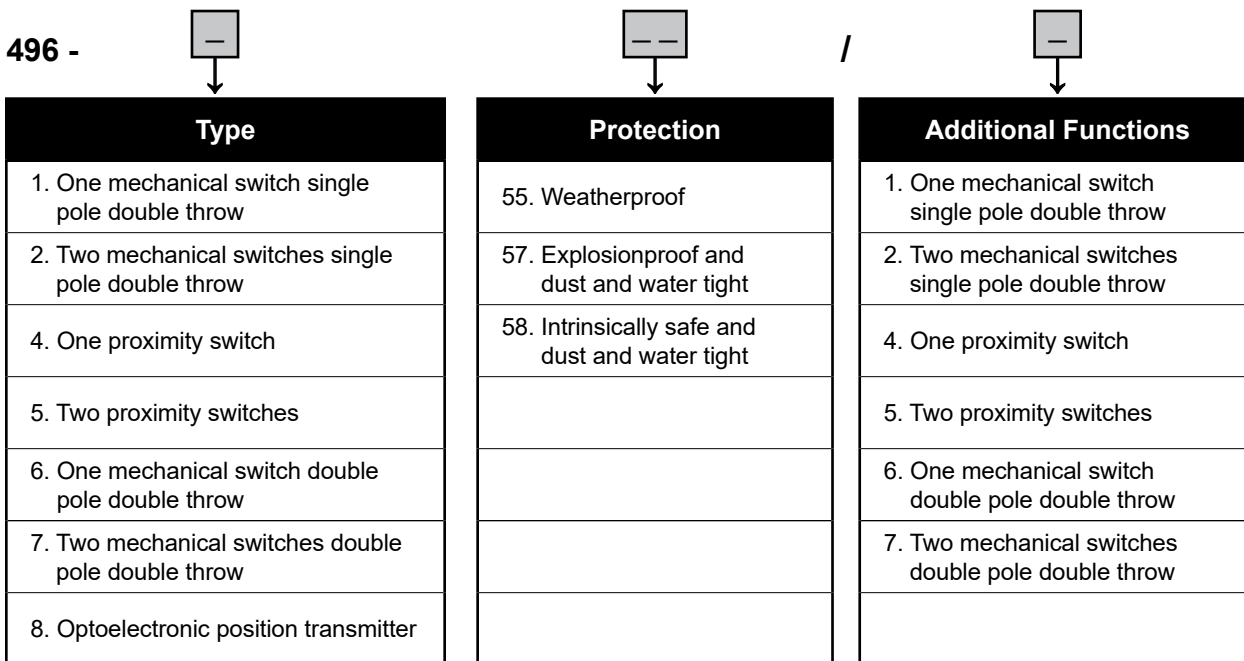

3. Technical Specification

Internal components for limit switch and position transmitter are mounted inside an IP66/IP67 enclosure.

Performances of position transmitter type 496-857 or 496-857/. and 496-858 or 496-858/.







- Output signal: 4-20 mA (2 wires)
- Acceptable span on the command axis: from 25° to 90° for rotary or reciprocating valves
- Rotation: clockwise or counterclockwise
- Linearity: $\leq \pm 0.5\%$ for a rotary angle of 25° to 90° (typically $\pm 0.3\%$ for a rotary angle $\geq 60^\circ$)
- Hysteresis: $\leq 0.1\%$
- Dead band: $\leq 0.1\%$
- Repeatability: $\leq 0.1\%$
- Total drift in temperature: 0.02%/°C or 200 ppm/°C (zero and span range)
- Operating temperature range: -40°C to +80°C

Electrical characteristics and temperature range of the position transmitter with micro-switch(es) or proximity switch(es) are given in the following sections.

4. ATEX Intrinsic Safety Marking and Electrical Safety Parameters

4.1 Marking

The marking is on the serial plate stamped on the 496 cover (rep 14).

- Name and address of the manufacturer: Dresser Produits Industriels S.A.S.14110 CONDE SUR NOIREAU - FRANCE
- Type designation:
 - **496-858** for position transmitter
 - **496-858/•** for position transmitter with additional function(s)the “•” can take the values **1, 2, 4, 5**
 - **496-•58** for position switchesthe “•” can take the values **1, 2, 4, 5**
 - **496-158/•** and **496-258/•** for position switches with additional function(s)the “•” can take the values **1, 2**
- Basic and complementary marking:
 - Position transmitter alone or Position transmitter equipped with microswitch(es) (additional function):
Types: 496-858 or 496-858/1 or 496-858/2
 **II 1 GD**
Ex ia IIC T.* Ga Tamb = -..°C à +..°C*
Ex ia IIIC T..°C* Da
 - Position transmitter equipped with proximity detector(s) (additional function):
Types: 496-858/4 or 496-858/5
 **II 1 GD**
Ex ia IIC T.* Ga Tamb = -..°C à +..°C*
 or
 **II 2 GD**
Ex ia IIC T.* Gb Tamb = -..°C à +..°C*
 - Position contactor alone equipped with microswitch(es):
Types: 496-158 or 496-258 or 496-158/• or 496-258/•
 **II 1 GD**
Ex ia IIC T.* Ga Tamb = -..°C à +..°C*
Ex ia IIIC T..°C* Da
 - Position contactor alone equipped with proximity detectors:
Types: 496-458 or 496-558
 **II 1 GD**
Ex ia IIC T.* Ga Tamb = -..°C à +..°C*
 or
 **II 2 GD**
Ex ia IIC T.* Gb Tamb = -..°C à +..°C *

*Ambient temperatures ranges and surface temperatures for the temperature classifications T6, T5 and T4 are given in **Annex I** with:

- Tables 1, 2 and 3 for the transmitter alone, the mechanical switch(es) alone and the proximity switch(es) alone.
- Tables 4 and 5 for the transmitter with mechanical switch(es) and for the transmitter with proximity switch(es).
- Serial number
- Year of manufacturing
- Number of notified body 
- EC-Type examination certificate number

WARNING
AVERTISSEMENT: DANGER POTENTIEL DE CHARGES ELECTROSTATIQUES – VOIR INSTRUCTIONS
WARNING: POTENTIAL DANGER OF ELECTROSTATIC CHARGES. SEE INSTRUCTIONS

4.2 Electrical safety parameters

4.2.1 Type 496-•58

4.2.1.1 Option with 1 or 2 Micro-Switch(es)

- Type identification is: **496-158 and 496-258**
- Mechanical switch(es): type BZ-2R72-A2, manufacturer: HONEYWELL
- They are supplied by a certified power source for explosible atmospheres group IIC with the maximal characteristics:
 - Constant power supply: $U_i = 30V$, $l_i = 0.5A$, $C_i = 0F$ and $L_i = 0H$
 - Alternative power supply: $U_i = 90V$, $l_i = 1.4A$, $C_i = 0F$ and $L_i = 0H$
- The wiring connection is done directly on mechanical switch(es).

4.2.1.2 Option with 1 or 2 Proximity Switch(es)

- Type identification is: **496-458 and 496-558**
- These detectors from PEPPERL & FUCHS are defined as:
 - II 1G Ex ia IIC T6 Ga
 - II 2G Ex ia IIC T6 Gb
- EC type examination certificate:
 - PTB 00 ATEX 2048 X (II1G, II2G)
 - PTB 00 ATEX 2049 X (II1G, II2G)
- They are supplied by a certified power source* for explosible atmospheres with the maximal characteristics: $U_i = 16V$; $l_i = 0.052A$; $P_i = 0.169W$.
 * The power source (Control circuit) must be one manufactured by Pepperl & Fuchs below: WE 77/EX 1 or WE 77/EX 2
- The wiring connection is done on one or two terminal connector type: MK 3 ; 2.5mm² ; 380 volts ; manufacturer: WEIDMULLER or equivalent product.

4.2.1.3 Maximum Characteristics

Variation		Ui (V)	Ii (A)	Ci (nF)	Li (µH)	Pi (W)
With Micro-Switch	DC Source	30	0.5	0	0	-
	AC Source Peak Value	90	1.4	0	0	-
With Proximity Switch		16	0.052	120	200	0.169

4.2.2 Types 496-858 and 496-858/ :

4.2.2.1 Type 496-858:

The position transmitter is connected to a certified linear power supply for explosible atmospheres Group IIC, IIB or IIA and its output circuit is recognized for an intrinsic safety used per **EN 60079-11**.

Maximum characteristics:

Ui (V)	Ii (A)	Ci (nF)	Li (µH)	Pi (W)
28	0.11	30	0	0.77

4.2.2.2 Type 496-858/ :

The additional functions of position transmitter are identical to type **496-58**

5. ATEX Flameproof Marking and Electrical Safety Parameters

5.1 Marking

The marking is on the serial plate stamped on the 496 cover (rep 14).

- Name and address of the manufacturer
Dresser Produits Industriels S.A.S.
14110 CONDE SUR NOIREAU – FRANCE
- Type designation:
 - 496-857** for position transmitter
 - 496-857/•** for position transmitter with additional function(s)
The • can be replaced by **1, 2, 4, 5, 6, 7**
 - 496-57** for position switches
The • can be replaced by **1, 2, 4, 5, 6, 7**
 - 496-157/•** and **496-257/•** for position switches with additional function(s)
The • can be replaced by **1, 2**
- The specific marking:  II 2 GD
- The complementary marking:
For position switch(es) **496-57** and **496-57/•** and position transmitter with or without additional function(s) **496-857** and **496-857/•**
 - Ex db IIC T6 Gb Ta –55°C, +75°C (*)
Ex tb IIIC T85°C Db IP66/IP67
 - Ex d IIC T5 Gb Ta –55°C, +85°C (*)
Ex tb IIIC T100°C Db IP66/IP67

(*) Ambient temperatures ranges and surface temperatures for the temperature classifications T6, T5 and T4 are given in **Annex II** with the different possible combinations allowed.

- Serial number
- Year of manufacturing
- Number of notified body **CE**....
- EC-Type examination certificate number

WARNING
AVERTISSEMENT: NE PAS OUVRIR SOUS TENSION
WARNING: DO NOT OPEN WHEN ENERGIZED

WARNING
AVERTISSEMENT: DANGER POTENTIEL DE CHARGES ELECTROSTATIQUES – VOIR INSTRUCTIONS
WARNING: POTENTIAL DANGER OF ELECTROSTATIC CHARGES. SEE INSTRUCTIONS

WARNING
AVERTISSEMENT: NE PAS OUVRIR SI UNE ATMOSPHERE EXPLOSIVE GAZEUSE EST PRESENTE
WARNING: DO NOT OPEN WHEN AN EXPLOSIVE GAS ATMOSPHERE IS PRESENT

- T cable:

Mandatory mention when the ambient temperature is higher than 70°C.

T ambient	T cable
70°C	75°C
75°C	80°C
80°C	85°C
85°C	90°C

5.2 Electrical safety parameter

- Maximum dispersed power = 5W
- Voltage supply allowable:

Type	Min Voltage	Max Voltage
496-157 or 496-257 or 496-657 or 496-757	-	220V (direct current) or 250V (alternative current)
496-457 or 496-557 Pepperl & Fuchs	-	16V (direct current)
496-457 or 496-557 Télémechanique	-	58V (direct current)
496-857/•	9.0V (direct current)	36V (direct current)

6. Position Transmitter 496-8../. Electrical data

- Power supply:

Voltage Supply U (V)	Mini	Maxi
Flameproof	9.0V	36V
Intrinsic Safety	9.0V	28V

- Lightning protection (in standard): 1500W 10/1000µs
- Output current 4-20mA (two wires)
- Zero range adjustment: ±0.5mA
- Span range adjustment: ±2.5mA
- Protected against polarity inversion
- Maximum load $Z_c(\Omega) = \frac{\text{Supply Voltage (V)} - 9.0 \text{ (V)}}{I_{maxi} \text{ (A)}}$

This means for 20mA:

$Z_c = 950 \text{ Ohm}$ max with for an intrinsically safe loop

and

$Z_c = 1350 \text{ Ohm}$ for Flameproof.

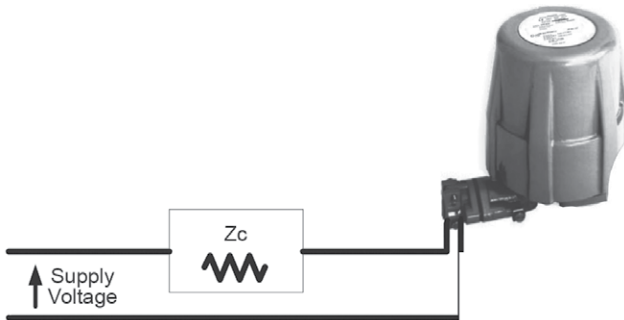

7. Electrical Connection, Installation and Start-up

- Comply with current national and local regulations for electrical installation work.
- Must be installed and put into service in conformance with EN 60079-14 and/or national and local regulations applicable for explosible atmospheres.
- Before carrying out any work on the device, power off the instrument or make sure that the local conditions in the potentially explosive atmosphere permit – the safe opening of the cover.
- Connect the wires to the instrument terminals, taking care of complying with polarities and maximum voltage allowed.
- Before power up or after doing any work on the device always check the cover (12) is fully screwed, O-ring (10) is free of any damage and security screw (9) is well locked.
- Check the earth terminals are well connected.

Note: Before installation, check that the device is undamaged. In the event of damage, inform the Manufacturer whose address is shown on the serial plate.

7.1 Conduit entry in flameproof application

The connections can be done with different variations taking into account approved manufacturer and requested approvals:

- A cable entry of a certified type **II 2 GD Ex d IIC / Ex tb IIIC** can be mounted directly on the single 3/4" NPT (ANSI/ ASME B1.20.1) housing conduit connection.
- Adaptor or reducer if ATEX apparatus certified or IECEx (type Cooper CAPRI CODEC)
- For multiple cable entries (3 maximum), the adaptor Y237 "Masoneilan" can be used for ATEX application only.
 - If one **Y237** input is not used, the conduit will be closed by a plug if ATEX apparatus certified (type Cooper CAPRI CODEC)
 - If two Y237 inputs are not used, the Y237 must be suppressed.
- The cable entry with or without its adaptor/reducer and the Y237 with its cable entry must be installed in conformance with Annex III.

7.2 Electrical connection for type 496-•57 or 496-•57/• and 496-•58 or 496-•58/•

- The electrical cables are connected either directly on to the micro switch(es) or to the proximity switch(es) terminal block.
- Connect the device to the earth using the earth connections provided inside and outside the housing of the device.
- Basic rule for wiring:
 - **Must be used in addition to local regulation for electrical installation**
 - **Connector slot approval:**

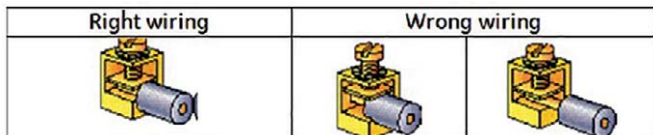

- **Insulation must be free of any damage along the wires inside the housing**
- **Tightening must be sufficient to bring constant contact in time without being excessive to cut or damage connection.**

7.3 Electrical connection for type 496-857 or 496-857/• and 496-858 or 496-858/•

Connect the electrical cables to the position transmitter terminal block located on the printed circuit board. Respect the polarities + and – and the maximum voltage allowed.

When a position transmitter is provided with an additional function, the electrical cables are connected either directly on to the micro switch(es) or to the proximity switch(es) terminal block.

Connect the device to the earth using the earth connections provided inside the housing and on the outside of the device.

- Basic rule for wiring:
 - **Must be used in addition to local regulation for electrical installation**
 - **Connector slot approval:**

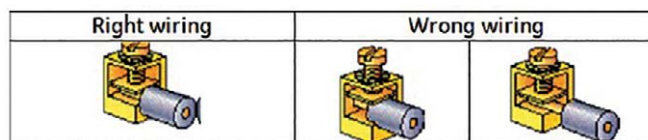

- **Insulation must be free of any damage along the wires inside the housing**
- **Tightening must be sufficient to bring constant contact in time without being excessive to cut or damage connection.**

7.4 Installation and start-up

7.4.1 Installation

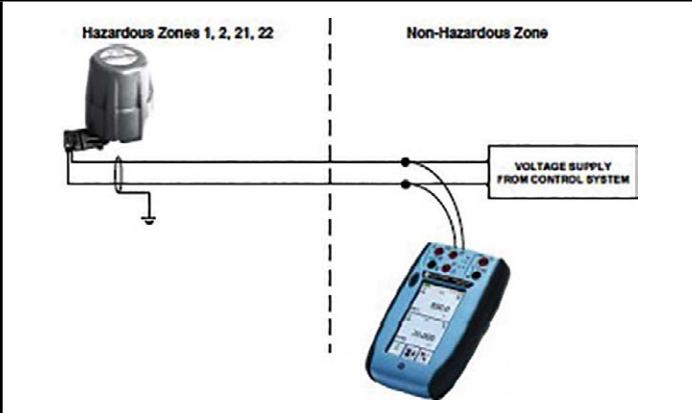
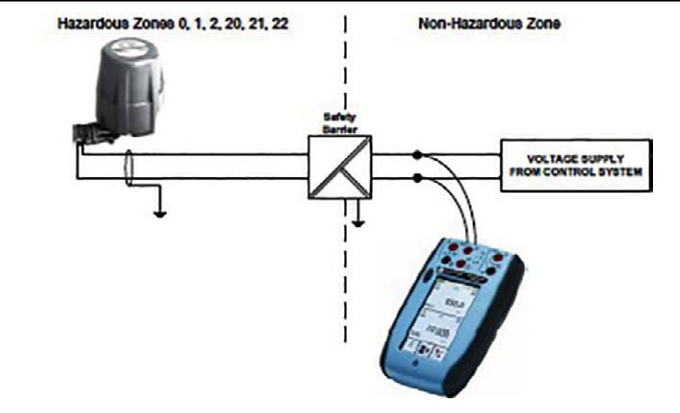
	
<p>Flameproof instrument may be installed in gas and dust explosive atmosphere of groups IIA, IIB, IIC and IIIC for the zones 1, 2, 21 and 22 with “db” and “tb” protection mode.</p>	<p>Intrinsically safe instrument may be installed in gas and dust explosive atmosphere of groups IIA, IIB, IIC and IIIC for zones 0, 1, 2, 20, 21 and 22 with “ia” protection mode.</p>
<p>Note: <i>It is under the user responsibility to check the installation against Intrinsic safety rules taking into account entity parameters of all devices in the loop in addition of temporary one like measurement devices.</i></p>	

7.4.2 Start-up

- Before power up or after doing any work on the device always check the cover (12) is fully screwed, O-ring (10) is free of any damage and security screw (9) is well locked.
- Check that the cable gland is certified for the intended use and that the electrical data are suitable for the operating zone.

Before start-up, proceed, if required, with instrument calibration as per §8 and/or ensure that all the safety instructions in the preceding paragraphs have been strictly followed.

8. Calibration

Before power up the device to proceed with calibration carefully read the following safety warnings.

- Comply with current national and local regulations for electrical installation work.
- Must be installed and put into service in conformance with EN 60079-14 and / or national and local regulations applicable for explosible atmospheres.
- Before carrying out any work on the device, power off the instrument or make sure that the local conditions in the potentially explosive atmosphere permit- the safe opening of the cover.
- Connect the wires to the instrument's terminals, taking care of complying with polarities and maximum voltage allowed.
- Before power up or after doing any work on the device always check the cover (12) is fully screwed, O-ring (10) is free of any damage and security screw (9) is well locked.

8.1 Calibration of rotary limit switch 496-157, 496-257, 496-158 and 496-258

- The concave portion of the lever (5) must be strictly concentric to the cam (13) when the micro-switch is actuated.
- This is an important caution to make sure the lever is properly depressed when not actuated.
- If not, loosen the screws (3 & 17) and slightly move the lever upwards or downwards. Tighten the screws.
- Slightly loosen the cam locking screw (1) using a 3/32" socket hex head wrench.
- Move the plug stem to the position required to actuate the switch.
- It is important to note that the cam operating the right hand micro-switch must actuate the lever (5) at the end of the counterclockwise rotation. (See detail figure below).
- This makes sure the screw (2) has free the lever (5) when the valve is throttling. The remaining concave portion only ensures micro-switch actuation in case of over travel. Conversely, the cam operating the left hand micro-switch must actuate the lever (5) at the end of the clockwise rotation. (See front view below).

- To meet the above requirement when only one micro-switch is provided (type 496-158) it may be necessary to change the location of the micro-switch.
- Rotate the cam (13) until the micro-switch is actuated. Lock the cam (13) tightening the screw (1).
- Fine tune adjustment with screw (2). Use a 1/16" socket hex head wrench. The screw (2) must come out the cam enough to properly depress the lever (5).
- Strictly follow safety instructions under §7.4 before putting into service.

8.2 Calibration of rotary limit switch 496-.57 and 496-.58 equipped with proximity switch(es)

8.2.1. Type 496-457 and 496-458

- Actuate the valve to the desired triggering position and check the sense of rotation when the arm leaves the proximity sensor.
- The figure below shows the location of the proximity sensor and of the arm when triggering as a function of the sense of rotation.
- Slowly move the arm towards the proximity sensor until it triggers. Triggering occurs when the arm overlaps approximately 1/3 of the proximity switch.
- Strictly follow safety instructions under §7.4 before putting into service.

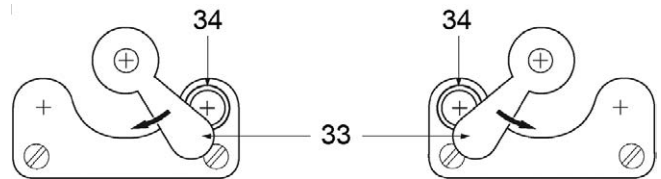

Rep.	Designation	Rep.	Designation
33	Arm	34	Proximity switch

8.2.2. Type 496-557 and 496-558

During adjustment make sure that the proximity switch with the red spot is triggered by the arm with the red spot.

- Adjustment of the first proximity switch
 - The first switch is adjusted at the beginning of the stroke.
 - Check what will be the sense of rotation when the valve is actuated. Figure (b, c) below shows the proximity sensor and the arm assigned to the first triggering point for a given the sense of rotation.
 - Slowly move the arm towards the proximity switch until it triggers.
- Adjustment of the second proximity switch
 - The second switch is adjusted at the end of the actuator stroke.
 - Immobilize the first arm previously adjusted and slowly move the second arm towards the second proximity sensor until it triggers.
 - Make sure the first proximity switch is still correctly adjusted.

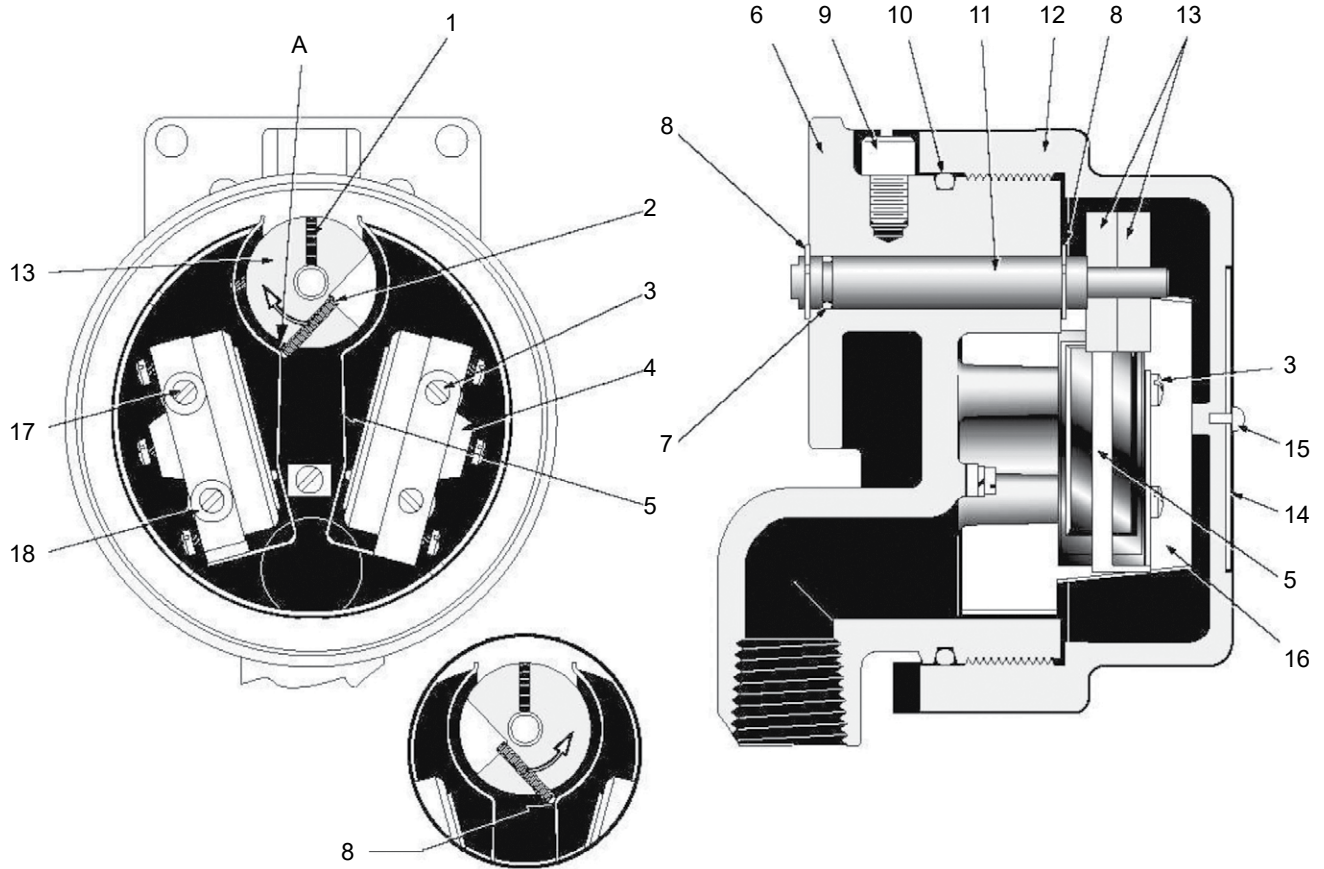

Parts List

Rep.	Designation	Rep.	Designation	Rep.	Designation
1	Adjusting screw	8	Snap ring		
2	Adjusting screw	9	Safety screw	16	Insulating
3	Screw (1 micro switch)	10 (1)	O-ring	17	Screw (second micro switch)
4	Micro switch	11	Axis	18	Washer
5	Lever	12	Cover	19 (2)	Spacer (Not shown)
6	Housing	13	Cam	A	Contact point for the left micro switch
7 (1)	O-ring	14	Serial plate	B	Contact point for the right micro switch
(1) Recommended spare parts		(2) Only for 496-2 model			

- Strictly follow safety instructions under §7.4 before putting into service.

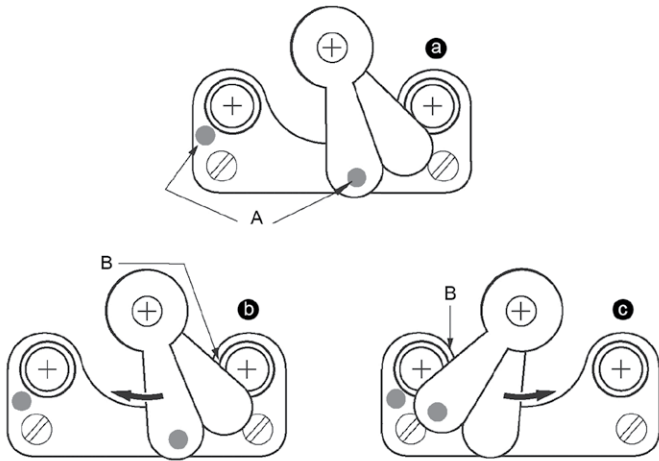

Rep.	Designation	Rep.	Designation
A	Red spot	B	First triggering point

8.2.3. Air-gap adjustment

Air-gap between the proximity switch and the arm is factory adjusted. If new adjustment is required proceed as follows:

- Loosen the proximity sensor nut (37A), located on the front of the bracket (36).
- Unscrew a few turns the locknut (37B) located on the back of the bracket.
- Position the arm above the proximity sensor and push the shaft end (11) towards the outside of the housing so as to eliminate the longitudinal play.
- Hold in position the proximity sensor and screw the nut (37A). Adjust air gap to 0,3 mm using a shim
- Tighten the lock nut (37B).

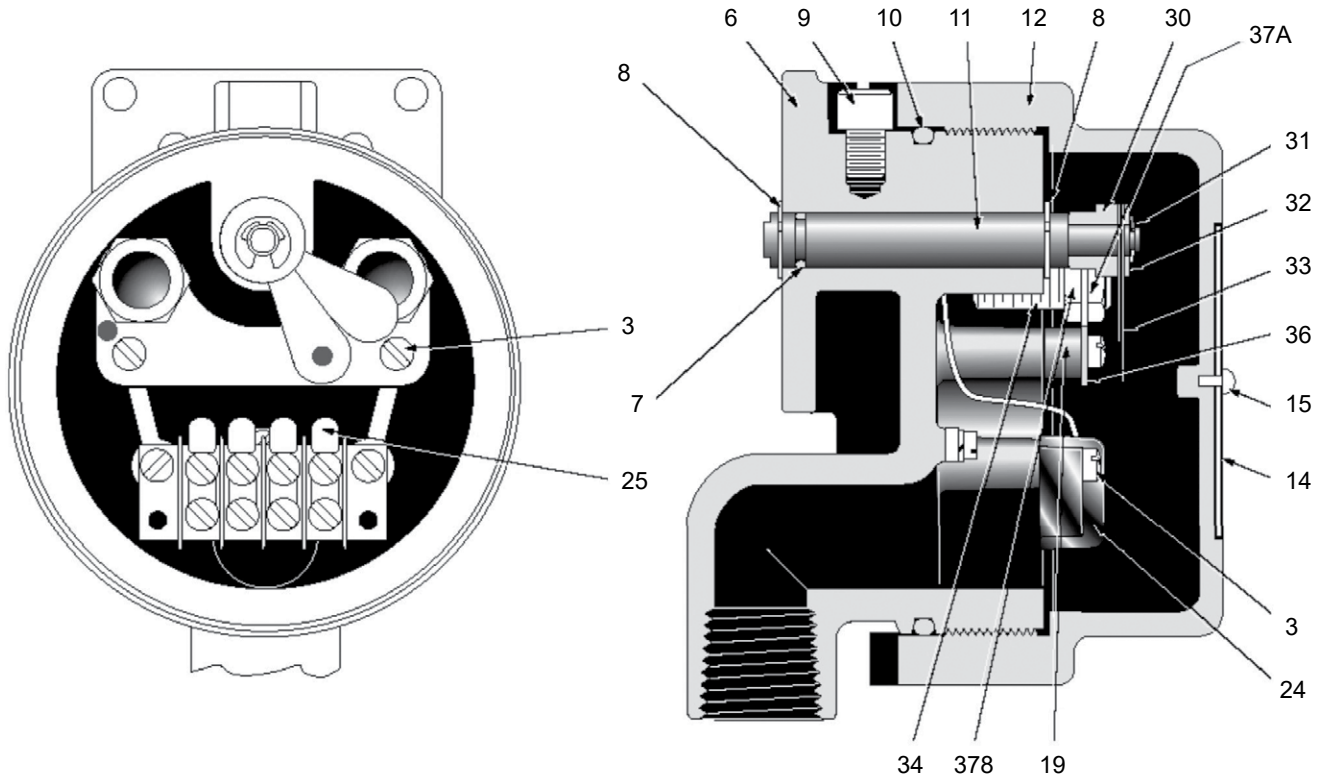

Parts List

Rep.	Designation	Rep.	Designation	Rep.	Designation
3	Screw	12	Cover	31	Snap ring
6	Housing	14	Serial plate	32	Washer
7 (1)	O-ring			33	Arm
8	Snap ring	19	Spacer	34	Proximity sensor
9	Safety screw	24	Terminal block	35 (2)	Spacer (Not shown)
10 (1)	O-ring	25	Terminal block	36	Sensor bracket
11	Axis	30	Spacer	37	Nut
(1) Recommended spare parts		(2) Only for 496-4 model			

8.3 Calibration of position transmitter 496-858 or 496-858/• and 496-857 or 496-857/•

• Action

The action sense of the valve (open or closed valve, compared to the 4 - 20 mA of the loop signal), determines the position of the connector 3 points of the optoelectronic sensor on one of the two connectors of electronic circuit A or B. The operation rule is: for a clockwise rotation of the pinion of the control shaft (view cover side), the output current increases (4→20 mA) when the connector of the optoelectronic sensor is connected in A and decreases when connected in B.

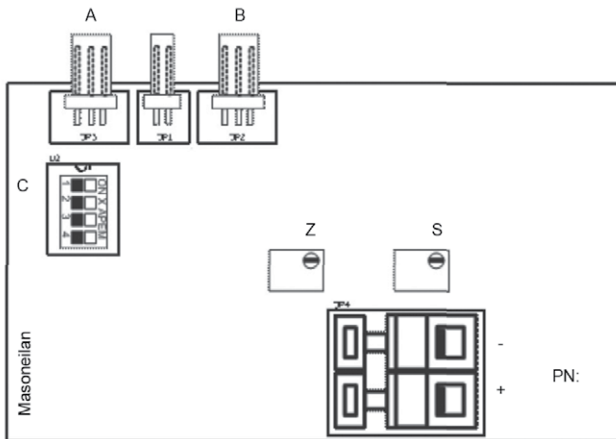

• Linkage adjustment

When mounted on reciprocating valves, adjust the turnbuckle to get the instrument lever perpendicular to the plug stem at mid-travel.

• Position transmitter adjustment

- Position the connector 3 points on connector A or B in function of the chosen action.
- Preset mid travel the zero adjustment (Z) if necessary*.
- Preset mid travel the span adjustment (S) if necessary**.
- Configure the switch C (see Annex IV) on the rotation angle of the control axle.
- Position the valve to the origin of travel that should correspond to the minimum of the signal (4 mA).
- Install a milliamp meter in series in the loop and power up the instrument.
- Rotate the primary pinion on the control axle to get an output signal around 4 mA.
- Fine tune-up of the 4 mA signal with the zero potentiometer (Z).
- Full stroke the valve to the rated travel and adjust the output signal to 20 mA with the span potentiometer (S).

- Check the zero and span calibration compared to the valve stroke. Repeat the zero and span calibration operations if necessary.
- * In case of problem of Zero adjustment due to the physical limits of the potentiometer, turn of 5 turns in the reverse direction that desired and turn the primary pinion to obtain an output current nearest to 4 mA.
- ** In case of problem of span adjustment due to the physical limits of the potentiometer, turn of 5 turns in the reverse direction that desired and configure the switch C (see Annex IV) for a higher or lower angle than that basis.
- **Adjustment of micro-switch(es) or proximity switch(es)**
Refer to paragraph §8.1 or §8.2 to adjust micro-switch(es) or proximity switch(es).
- **Strictly follow safety instructions under §7.4 before putting into service.**

9. Maintenance

- **Before carrying out any work on the device, power off the instrument or make sure the local conditions are free of potentially explosive atmosphere for safe opening of the cover.**
- **These operations must be done in conformance with EN 60079-17 and / or national and local regulations applicable for explosible atmospheres.**
- **Before power up or after doing any work on the device always check the cover (12) is fully screwed, O-ring (10) is free of any damage and security screw (9) is well locked.**

- Check that no part of the 496 is damaged. In the event of damage replace the defective parts with genuine manufacturer's replacement part.
- Pay particular attention to the following:
 - Check device, mechanical link and general aspect.
 - Check the cable gland and the electrical connections.
 - Check the condition of the O-ring (10) of cover (12) and O-ring (7) of the shaft (11).
 - Make sure that shaft (11) is not worn out or damaged.
 - If the shaft (11) must be removed, make sure the original circlips (8) is put back in place. Check that neither the housing nor the shaft are damaged.
- Instruments installed in zones 20, 21 and 22 must be cleaned to prevent any dust build up on the walls. See instruction §11.1 b & c for safe cleaning.

10. Special Conditions of Work

Based on 2014/34/EU directive, a training session must be followed by person usually recognized to use apparatus in explosible atmospheres.

This training session is not supported by Dresser Produits Industriels S.A.S.

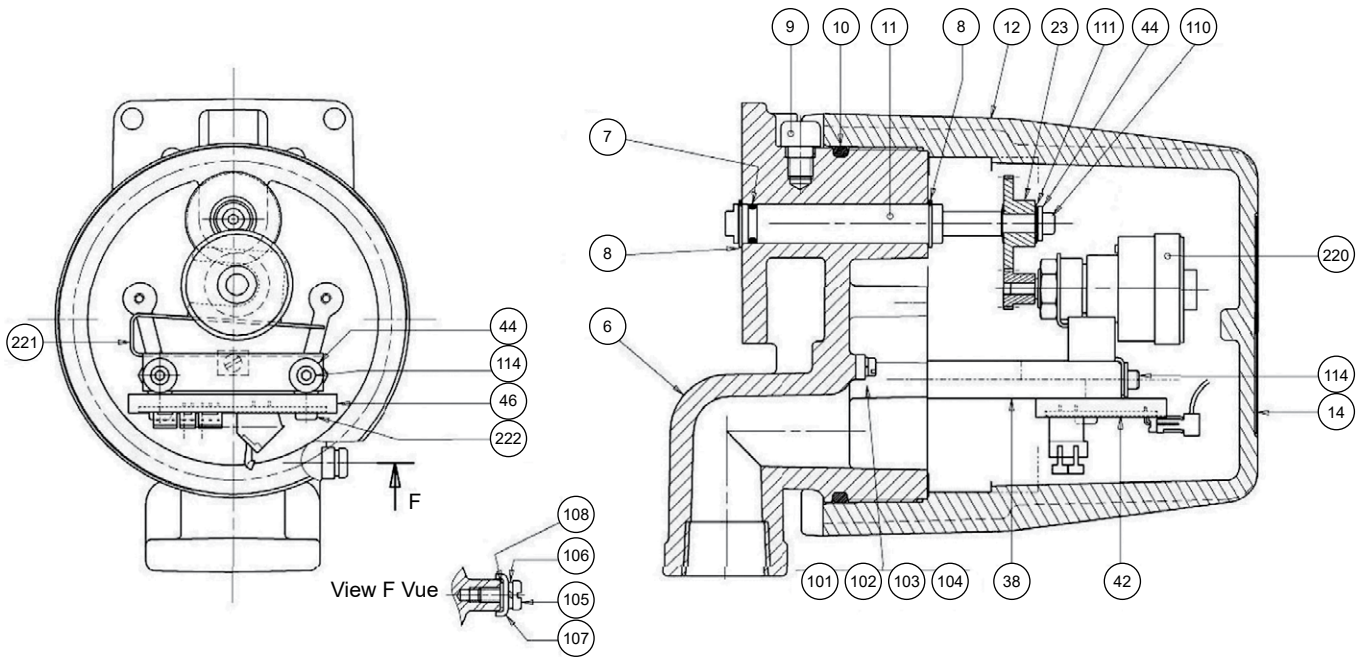

Parts List

Rep.	Designation	Rep.	Designation	Rep.	Designation
6	housing	38	spacer	106	Grower washer
7	O-ring	42	electronic card	107	stirrup
8	circlips	44	washer	108	washer
9	CHC screw	46	card support	110	screw
10	O-ring	101	ground screw (inside)	111	spring washer
11	shaft	102	Grower washer	114	CHC screw
12	cover	103	stirrup	220	detector set
14	serial plate	104	washer	221	detector support
23	pinion	105	ground screw (outside)	222	screw

11. Special Conditions of Use

11.1. For Intrinsic Safety & Flameproof Types 496-•58, 496-•58/•, 496-858, 496-858/• and Types 496-•57, 496-•57/•, 496-857, 496-857/•

- a. It is under the user responsibility to check once a year the gaskets and in the event of damage to replace the defective parts with manufacturer’s replacement parts only.
- b. For use in dusty hazardous areas, the user will have to proceed to a cleaning regularly the different sides of the enclosure to avoid the deposits of dusts, the maximum thickness must be <5 mm. This cleaning will be done using recommendations defined in §c.

For safe operation, this can be done only if the local conditions around the device are free of potentially explosive atmosphere.

- c. To avoid any spark due to electrostatic discharges, it is requested to follow the instructions of *IEC/TS 60079-32-1*. For example, the user will proceed a cleaning of the device and mainly the plastic label with a wet rag to.

For safe operation, this can be done only if the local conditions around the device are free of potentially explosive atmosphere.

- d. The user will have to check the temperature increase on the 496 head coming from the mechanical part in contact with the 496 housing or through the process thermal radiation be less or equal than the temperature classification allowed. This must be done in conformance with *EN 60079-14* and/or national and local regulations applicable for explosible atmospheres.
- e. The final user during the 496 installation on site must show the protection mode used on the serial plate removing the tears off tabs or putting a cross in the dedicated area. This is a requirement only for multi protection marking. The label here on the right is shown for example only and not representative to the 496 label.

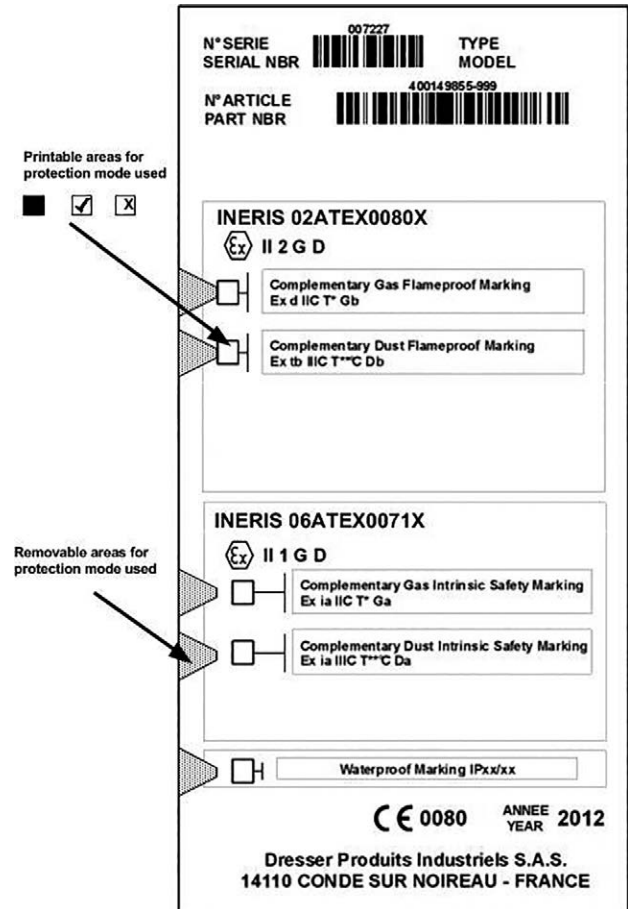

11.2 Intrinsically safe apparatus:

Types 496-58, 496-58/• and

Types 496-858, 496-858/•

- The cable entry must have a protection level at least equal to IP6X according to EN 60529 standards.
- For using in zone 0 (category 1) and with aluminum housing, precautions must be taken to prevent that apparatus is not subject to any mechanical shocks.
- The linear power supply of the position transmitter / position contactor must be of a certified type for a use in the explosive atmospheres of IIC, IIB or IIA group and its output circuit recognized of intrinsic safety.
- The maximum characteristics of these sources should not exceed the characteristics indicated in § 4.2

11.3 Explosion proof apparatus:

Types 496-57, 496-57/•, 496-857, 496-857/•

- When the ambient temperature is higher than 70°C, the user will have to choose a cable entry and a cable compatible with the data of the table below:

T ambient	T cable
70°C	75°C
75°C	80°C
80°C	85°C
85°C	90°C

- The minimal temperature of the cable is indicated on the serial plate.
- When the ambient temperature is lower than -20°C, the user will have to choose a cable entry and a cable compatible with the lowest possible ambient temperature. For reminder, 496-57 and 496-57/• series are certified up to -55°C.
- The cable entry must have a degree of protection at least equal to IP66/67.
- Use only the following greases for the explosion- proof gaskets, shaft, cover threads, cable gland and plug for Y237:

Type	Manufacturer
SI 33	ORAPI
GRAPHENE 702	ORAPI
MOLYKOTE 111 COMPOUND	MOLYKOTE®
MULTILUB	MOLYKOTE®
GRIPCOTT NF	MOLYDAL

- All mechanical parts coupled with the limit switch or transmitter and likely to generate a spark or a hot surface will have to be the object, on behalf of the user, an analysis of the risks in agreement with the Directive 2014/34/EU. The user will have to follow the conformity module adapted to the zone in which it will be installed.
- Explosion-proof joint:
 - The explosion-proof shaft joint tolerance is lower than one defined by the standard EN 60079-1. It must be respected with a maximum radial gap of 0.133mm.
 - The length of explosion-proof joints is greater than the one defined in the sheets of EN 60079-1.
 - The explosion-proof joints are not intended to be repaired.

Annex I - Intrinsic Safety

TABLE 1			MIN and MAX PERMISSIBLE AMBIENT TEMPERATURES FOR APPLICATION IN THE FOLLOWING TEMPERATURE CLASS					
TYPE 496-858	Ci	Li	1G/2G/1D	1G/ 2G (EPL Ga, Gb)			1D (EPL Da)	
	nF	μH	MIN	T6	T5	T4	T85°C (T6)	T100°C (T5)
Transmitter	36	0	-40	70	80	80	70	80

TABLE 2			MIN and MAX PERMISSIBLE AMBIENT TEMPERATURES FOR APPLICATION IN THE FOLLOWING TEMPERATURE CLASS					
TYPE 496-158 and 496-258	Ci	Li	1G/2G/1D	1G/ 2G (EPL Ga, Gb)			1D (EPL Da)	
	nF	μH	MIN	T6	T5	T4	T85°C (T6)	T100°C (T5)
Honeywell BZ-2R-72-A2	0	0	-55	80	80	80	70	80

TABLE 3			MIN and MAX PERMISSIBLE AMBIENT TEMPERATURES FOR APPLICATION IN THE FOLLOWING TEMPERATURE CLASS									
TYPE 496-458 and 496-558	Ci	Li	1G/2G/1D	1G/ 2G (EPL Ga)			2G (EPL Gb)			1D (EPL Da)		
	nF	μH	MIN	T6	T5	T4	T6	T5	T4	T85°C (T6)	T100°C (T5)	
PEPPER + FUCHS	NJ2-11N-G	30	50	-25	45	57	81	62	77	81		
	NJ2-11SN-G	50	150	-40	45	57	81	62	77	81		
	NJ2-12GK-N	45	50	-25				51	66	80		
	NJ2-12GK-SN	50	150	-40	34	46	74	51	66	80		
	NJ2-12GM-N	30	50	-25	45	57	81	62	77	81		
	NCB2-12GM35 NO	90	100	-25	45	57	81	62	77	81		
	NJ3-18GK-S1N	70	200	-25	34	46	74	51	66	80		
	NJ4-12GK-N	45	50	-25				51	66	80		
	NJ5-18GK-SN	70	150	-50	34	46	74	51	66	80		
	NJ5-18GK-N	70	50	-25	34	46	74	51	66	80		
	NJ5-18GK-SN	120	200	-40	34	46	74	51	66	80		
	NJ5-18GM-N	70	50	-25	45	57	81	62	77	81		
	NJ5-30GK-S1N	100	200	-25	34	46	74	51	66	80		
NCB5-18GM40 NO	95	100	-25	45	57	81	62	77	81			

TABLE 4			MIN and MAX PERMISSIBLE AMBIENT TEMPERATURES FOR APPLICATION IN THE FOLLOWING TEMPERATURE CLASS					
TYPE 496-858/1 and 496-858/2	Ci	Li	1G/2G/1D	1G/ 2G (EPL Ga, Gb)			1D (EPL Da)	
	nF	μH	MIN	T6	T5	T4	T85°C (T6)	T100°C (T5)
Honeywell Transmitter + BZ-2R-72-A2	30	0	-40	70	80	80	70	80



 non-applicable

TABLE 5				MIN and MAX PERMISSIBLE AMBIENT TEMPERATURES FOR APPLICATION IN THE FOLLOWING TEMPERATURE CLASS								
TYPE 496-858/4 and 496-858/5	Ci	Li	1G/2G/1D	1G/ 2G (EPL Ga)			2G (EPL Gb)			1D (EPL Da)		
	nF	μH	MIN	T6	T5	T4	T6	T5	T4	T85°C (T6)	T100°C (T5)	
PEPPER + FUCHS	Transmitter + NJ2-11N-G	30	50	-25	45	57	80	62	77	80		
	Transmitter + NJ2-11SN-G	50	150	-40	45	57	80	62	77	80		
	Transmitter + NJ2-12GK-N	45	50	-25				51	66	80		
	Transmitter + NJ2-12GK-SN	50	150	-40	34	46	74	51	66	80		
	Transmitter + NJ2-12GM-N	30	50	-25	45	57	80	62	77	80		
	Transmitter + NCB2-12GM35 NO	90	100	-25	45	57	80	62	77	80		
	Transmitter + NJ3-18GK-S1N	70	200	-25	34	46	74	51	66	80		
	Transmitter + NJ4-12GK-N	45	50	-25				51	66	80		
	Transmitter + NJ4-12GK-SN	70	150	-50	34	46	74	51	66	80		
	Transmitter + NJ5-18GK-N	70	50	-25	34	46	74	51	66	80		
	Transmitter + NJ5-18GK-SN	120	200	-40	34	46	74	51	66	80		
	Transmitter + NJ5-18GM-N	70	50	-25	45	57	80	62	77	80		
	Transmitter + NJ5-30GK-S1N	100	200	-25	34	46	74	51	66	80		
	Transmitter + NCB5-18GM40 NO	95	100	-25	45	57	80	62	77	80		

 non-applicable

Annex II - Flameproof

TABLE 1		MIN and MAX PERMISSIBLE AMBIENT TEMPERATURES FOR APPLICATION IN THE FOLLOWING TEMPERATURE CLASS			
TYPE 496-857	2G/D	2G (EPL Gb)		2D (EPL Db)	
	MIN	T6	T5	T85°C	T100°C
Transmitter	-40	75	80	75	80

TABLE 2		MIN and MAX PERMISSIBLE AMBIENT TEMPERATURES FOR APPLICATION IN THE FOLLOWING TEMPERATURE CLASS				
TYPE 496-157 and 496-257	2G/D	2G (EPL Gb)		2D (EPL Db)		
	MIN	T6	T5	T85°C	T100°C	
Honeywell	1HS1	-55	75	85	75	85
	BZ-2R-72-A2	-55	75	85	75	85
	BZ R-A2	-55	75	85	75	85

TABLE 3		MIN and MAX PERMISSIBLE AMBIENT TEMPERATURES FOR APPLICATION IN THE FOLLOWING TEMPERATURE CLASS				
TYPE 496-657 and 496-757	2G/D	2G (EPL Gb)		2D (EPL Db)		
	MIN	T6	T5	T85°C	T100°C	
Honeywell	DT-2R-A7	-55	75	85	75	85

TABLE 4		MIN and MAX PERMISSIBLE AMBIENT TEMPERATURES FOR APPLICATION IN THE FOLLOWING TEMPERATURE CLASS				
TYPE 496-457 and 496-557	2G/D	2G (EPL Gb)		2D (EPL Db)		
	MIN	T6	T5	T85°C	T100°C	
PEPPER + FUCHS	NJ2-11N-G	-25	75	85	75	85
	NJ2-11SN-G	-40	75	85	75	85
	NJ2-12GK-N	-25	75	85	75	85
	NJ2-12GK-SN	-40	75	85	75	85
	NJ2-12GM-N	-25	75	85	75	85
	NCB2-12GM35 NO	-25	75	85	75	85
	NJ3-18GK-S1N	-25	75	85	75	85
	NJ4-12GK-N	-25	75	85	75	85
	NJ4-12GK-SN	-50	75	85	75	85
	NJ5-18GK-N	-25	75	85	75	85
	NJ5-18GK-SN	-40	75	85	75	85
	NJ5-18GM-N	-25	75	85	75	85
	NJ5-30GK-S1N	-25	75	85	75	85
	NCB5-18GM40 NO	-25	75	85	75	85
	NCB2-12GM40-Z0	-25	70	70	70	70
	NBB2-12GM40-Z0	-25	70	70	70	70
	NBN4-12GM40-Z0	-25	70	70	70	70
	NJ2-12GM40-E2	-25	70	70	70	70
	NCB5-18GM40-Z0	-25	70	70	70	70
NJ4-12GK40-E2	-25	70	70	70	70	
TELEMECANIQUE	XS512B1DAL2	-25	70	70	70	70
	XS518B1DAL2	-25	70	70	70	70
	XS612B1MAL2	-25	70	70	70	70
TURCK	Bi2S12AZ31X/S97	-40	70	70	70	70
	Bi5S18AZ3X/S97	-40	70	70	70	70

TABLE 5		MIN and MAX PERMISSIBLE AMBIENT TEMPERATURES FOR APPLICATION IN THE FOLLOWING TEMPERATURE CLASS				
	TYPE 496-857/1 and 496-857/2	2G/D	2G (EPL Gb)		2D (EPL Db)	
		MIN	T6	T5	T85°C	T100°C
Honeywell	Transmitter + 1HS1	-40	75	80	75	80
	Transmitter + BZ-2R-72-A2	-40	75	80	75	80
	Transmitter + BZ R-A2	-40	75	80	75	80

TABLE 6		MIN and MAX PERMISSIBLE AMBIENT TEMPERATURES FOR APPLICATION IN THE FOLLOWING TEMPERATURE CLASS				
	TYPE 496-857/6 and 496-857/7	2G/D	2G (EPL Gb)		2D (EPL Db)	
		MIN	T6	T5	T85°C	T100°C
Honeywell	Transmitter + DT-2R-A7	-40	75	80	75	80

TABLE 7		MIN and MAX PERMISSIBLE AMBIENT TEMPERATURES FOR APPLICATION IN THE FOLLOWING TEMPERATURE CLASS				
	TYPE 496-857/4 and 496-857/5	2G/D	2G (EPL Gb)		2D (EPL Db)	
		MIN	T6	T5	T85°C	T100°C
PEPPER + FUCHS	Transmitter + NJ2-11N-G	-25	75	80	75	80
	Transmitter + NJ2-11SN-G	-40	75	80	75	80
	Transmitter + NJ2-12GK-N	-25	75	80	75	80
	Transmitter + NJ2-12GK-SN	-40	75	80	75	80
	Transmitter + NJ2-12GM-N	-25	75	80	75	80
	Transmitter + NCB2-12GM35 NO	-25	75	80	75	80
	Transmitter + NJ3-18GK-S1N	-25	75	80	75	80
	Transmitter + NJ4-12GK-N	-25	75	80	75	80
	Transmitter + NJ4-12GK-SN	-50	75	80	75	80
	Transmitter + NJ5-18GK-N	-25	75	80	75	80
	Transmitter + NJ5-18GK-SN	-40	75	80	75	80
	Transmitter + NJ5-18GM-N	-25	75	80	75	80
	Transmitter + NJ5-30GK-S1N	-25	75	80	75	80
	Transmitter + NCB5-18GM40 NO	-25	75	80	75	80
	Transmitter + NCB2-12GM40-Z0	-25	70	70	70	70
	Transmitter + NBB2-12GM40-Z0	-25	70	70	70	70
	Transmitter + NBN4-12GM40-Z0	-25	70	70	70	70
	Transmitter + NJ2-12GM40-E2	-25	70	70	70	70
Transmitter + NCB5-18GM40-Z0	-25	70	70	70	70	
Transmitter + NJ4-12GK40-E2	-25	70	70	70	70	
TELEMECANIQUE	Transmitter + XS512B1DAL2	-25	70	70	70	70
	Transmitter + XS518B1DAL2	-25	70	70	70	70
	Transmitter + XS612B1MAL2	-25	70	70	70	70
TURCK	Transmitter + Bi2S12AZ31X/S97	-40	70	70	70	70
	Transmitter + Bi5S18AZ3X/S97	-40	70	70	70	70

Annex III

CABLE GLAND – ADAPTOR - REDUCER MOUNTING RULES			
CABLE GLAND		ADAPTOR - REDUCER	
496 Housing certified II 2 GD Ex db IIC / Ex tb IIC	Cable gland certified II 2 GD Ex db IIC / Ex tb IIC	Housing certified II 2 GD Ex db IIC / Ex tb IIC	Adaptor-Reducer certified II 2 GD Ex db IIC / Ex tb IIC
<p>TYPE</p> <p>Male Taper (conical) threaded joint: $\frac{3}{4}$" NPT</p> <ul style="list-style-type: none"> Conform to NPT requirements of ANSI/ASME B1.20.1 A minimum of 5 threads provided on each part <p>MOUNTING RULE</p> <ul style="list-style-type: none"> Thread cleaning with Loctite 7063 or equivalent product with similar efficiency. Cemented with Loctite 5400 (low strength thread sealant) or equivalent product with similar efficiency. This is mandatory to meet an IP67. Tightening torque (see Cable Gland instruction manual) Check threads engagement (see Cable Gland instruction manual) 		<p>A:</p> <p>TYPE</p> <p>Male Taper (conical) threaded joint: $\frac{3}{4}$" NPT</p> <ul style="list-style-type: none"> Conform to NPT requirements of ANSI/ASME B1.20.1 A minimum of 5 threads provided on each part <p>MOUNTING RULE</p> <ul style="list-style-type: none"> Thread cleaning with Loctite 7063 or equivalent product with similar efficiency. Cemented with Loctite 2700 (high-strength threadlocker) or equivalent product with similar efficiency. This is mandatory to meet an IP67. Tightening torque (see Adaptor-Reducer instruction manual) Check threads engagement (see Adaptor-Reducer instruction manual) <p>B:</p> <p>TYPE</p> <p>Female Taper (conical) thread joints: $\frac{1}{2}$" NPT or other NPT size</p> <ul style="list-style-type: none"> Conform to ISO 965-1 and ISO 965-3 requirements Minimum thread engaged: 5 Depth of engagement: ≥ 8 mm <p>MOUNTING RULE</p> <ul style="list-style-type: none"> Thread cleaning with Loctite 7063 or equivalent product with similar efficiency. Cemented with Loctite 5400 (low strength thread sealant) or equivalent product with similar efficiency. This is mandatory to meet an IP67. Tightening torque (see Cable Gland instruction manual) Check threads engagement (see Cable Gland instruction manual) 	

Y237 ADAPTOR – MOUNTING RULES

CABLE GLAND		PLUG	
Housing certified II 2 GD Ex db IIC / Ex tb IIC	Cable gland certified II 2 GD Ex db IIC / Ex tb IIC	Housing certified II 2 GD Ex db IIC / Ex tb IIC	Plug certified II 2 GD Ex db IIC / Ex tb IIC
<p>A: TYPE Male Taper (conical) threaded joint: ¾" NPT</p> <ul style="list-style-type: none"> Conform to NPT requirements of ANSI/ASME B1.20.1 A minimum of 5 threads provided on each part <p>MOUNTING RULE</p> <ul style="list-style-type: none"> Thread cleaning with Loctite 7063 or equivalent product with similar efficiency. Cemented with Loctite 2700 (high-strength threadlocker) or equivalent product with similar efficiency. This is mandatory to meet an IP67. Tightening torque (see Cable Gland instruction manual) Check threads engagement (see Cable Gland instruction manual) <p>B: TYPE Female Taper (conical) thread joints: ½" NPT or ¾" NPT</p> <ul style="list-style-type: none"> Conform to NPT requirements of ANSI/ASME B.1.20.1 Minimum thread engaged: 5 A minimum of 5 threads provided on each part <p>TYPE: Female Cylindrical threaded joints: M20 x 1.5</p> <ul style="list-style-type: none"> Conform to ISO 965-1 and ISO 965-3 requirements Minimum thread engaged: 5 Depth of engagement: ≥ 8 mm <p>MOUNTING RULE</p> <ul style="list-style-type: none"> Thread cleaning with Loctite 7063 or equivalent product with similar efficiency. Cemented with Loctite 5400 (low strength thread sealant) or equivalent product with similar efficiency. This is mandatory to meet an IP67. Tightening torque (see Cable Gland instruction manual) Check threads engagement (see Cable Gland instruction manual) 		<p>A: TYPE Male Taper (conical) threaded joint: ¾" NPT</p> <ul style="list-style-type: none"> Conform to NPT requirements of ANSI/ASME B1.20.1 A minimum of 5 threads provided on each part <p>MOUNTING RULE</p> <ul style="list-style-type: none"> Thread cleaning with Loctite 7063 or equivalent product with similar efficiency. Cemented with Loctite 2700 (high-strength threadlocker) or equivalent product with similar efficiency. This is mandatory to meet an IP67. Tightening torque (see Cable Gland instruction manual) Check threads engagement (see Cable Gland instruction manual) <p>B: TYPE Female Taper (conical) thread joints: ½" NPT or ¾" NPT</p> <ul style="list-style-type: none"> Conform to NPT requirements of ANSI/ASME B.1.20.1 Minimum of 5 threads provided on each part <p>TYPE: Female Cylindrical threaded joints: M20 x 1.5</p> <ul style="list-style-type: none"> Conform to ISO 965-1 and ISO 965-3 requirements Minimum thread engaged: 5 Depth of engagement: ≥ 8 mm <p>MOUNTING RULE</p> <ul style="list-style-type: none"> Thread cleaning with Loctite 7063 or equivalent product with similar efficiency. Cemented with Loctite 2700 (high-strength threadlocker) or equivalent product with similar efficiency. This is mandatory to meet an IP67. Tightening torque (see Cable Gland instruction manual) Check threads engagement (see Cable Gland instruction manual) One plug only allowed or remove the Y237 (two plugs not allowed) 	

Annex IV

Switch Configuration According to the Rotation Angle of the Control Axle								
$\leq 24^\circ$ and $< 30^\circ$	$\leq 30^\circ$ and $< 36^\circ$	$\leq 36^\circ$ and $< 42^\circ$	$\leq 42^\circ$ and $< 48^\circ$	$\leq 48^\circ$ and $< 54^\circ$	$\leq 54^\circ$ and $< 62^\circ$	$\leq 62^\circ$ and $< 70^\circ$	$\leq 70^\circ$ and $< 80^\circ$	$\leq 80^\circ$ and $\leq 90^\circ$
Concerned Apparatus								
<ul style="list-style-type: none"> • 87/88 strokes $\frac{1}{2}$" to 0,8" • 37/38 strokes $\frac{1}{2}$" to $\frac{3}{4}$" • Sigma F stroke $\frac{3}{4}$" 		<ul style="list-style-type: none"> • Varimax • 67/68 stroke 5" 		<ul style="list-style-type: none"> • Camflex • Varipak • 3100 • 87/88 strokes 1" to 2,5" • 37/38 strokes 1" to 4" • Sigma F strokes 1,5" to 2" • 67/68 stroke 6" 		<ul style="list-style-type: none"> • 67/68 stroke 8: 	<ul style="list-style-type: none"> • Minitork 	<ul style="list-style-type: none"> • Ball

This page intentionally left blank.

Notes

Notes

Find the nearest local Channel Partner in your area:

valves.bakerhughes.com/contact-us

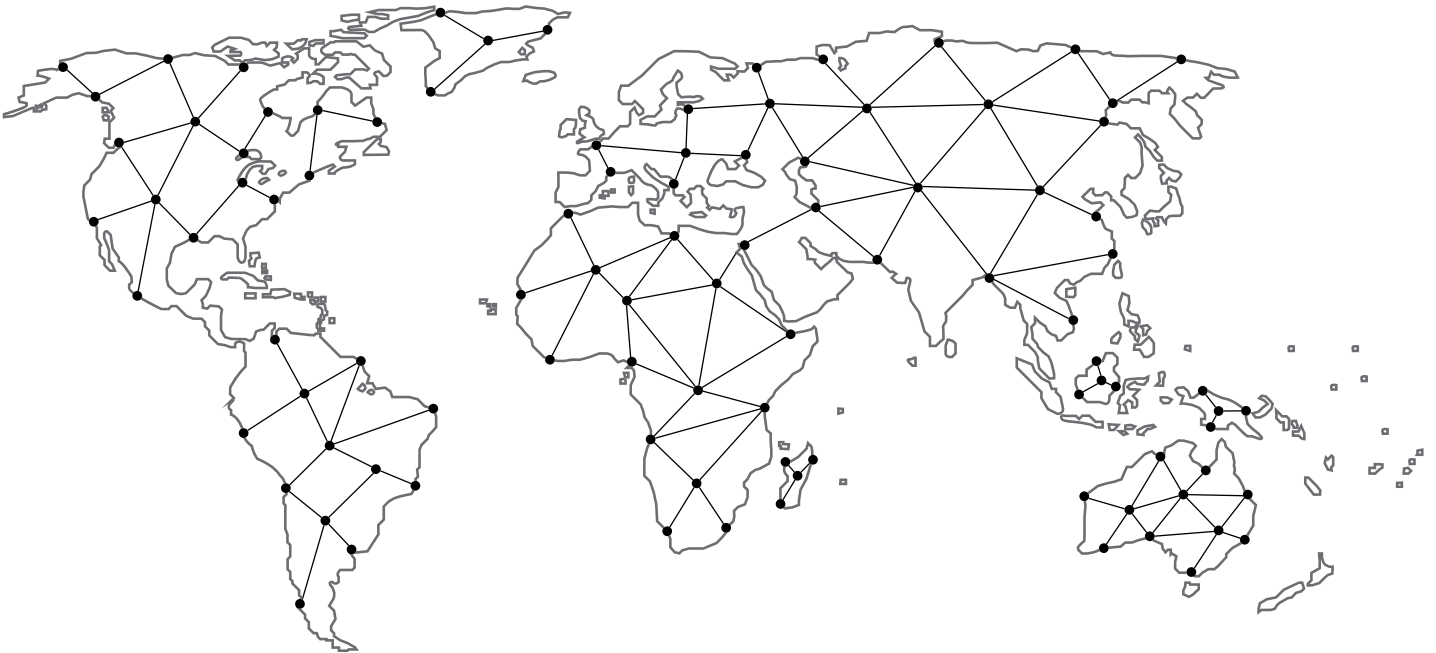

Tech Field Support & Warranty:

Phone: +1-866-827-5378

valvesupport@bakerhughes.com

valves.bakerhughes.com

Copyright 2020 Baker Hughes Company. All rights reserved. Baker Hughes provides this information on an "as is" basis for general information purposes. Baker Hughes does not make any representation as to the accuracy or completeness of the information and makes no warranties of any kind, specific, implied or oral, to the fullest extent permissible by law, including those of merchantability and fitness for a particular purpose or use. Baker Hughes hereby disclaims any and all liability for any direct, indirect, consequential or special damages, claims for lost profits, or third party claims arising from the use of the information, whether a claim is asserted in contract, tort, or otherwise. Baker Hughes reserves the right to make changes in specifications and features shown herein, or discontinue the product described at any time without notice or obligation. Contact your Baker Hughes representative for the most current information. The Baker Hughes logo and Masoneilan are trademarks of Baker Hughes Company. Other company names and product names used in this document are the registered trademarks or trademarks of their respective owners.

Baker Hughes 