

# Model CTF878

Clamp-On Tag Flowmeter

**Startup Guide**





# Model CTF878

Clamp-On Tag Flowmeter

## Startup Guide

BH010C41 EN B  
August 2023

[panametrics.com](https://panametrics.com)

Copyright 2023 Baker Hughes company.

This material contains one or more registered trademarks of Baker Hughes Company and its subsidiaries in one or more countries. All third-party product and company names are trademarks of their respective holders.

[no content intended for this page]

## Services

Panametrics provides customers with an experienced staff of customer support personnel ready to respond to technical inquiries, as well as other remote and on-site support needs. To complement our broad portfolio of industry-leading solutions, we offer several types of flexible and scalable support services including: Training, Product Repairs, Service Agreements and more. Please visit [www.bakerhughes.com/panametrics/panametrics-services](http://www.bakerhughes.com/panametrics/panametrics-services) for more details.

## Terms and Conditions

Sales *Terms and Conditions* for your recent purchase of a BH product, including the applicable product Warranty, can be found on our website at the following link: <https://www.bakerhughesds.com/sales-terms-conditions>

## Typographical Conventions

**Note:** *These paragraphs provide information that provides a deeper understanding of the situation, but is not essential to the proper completion of the instructions.*

**IMPORTANT:** These paragraphs provide information that emphasizes instructions that are essential to proper setup of the equipment. Failure to follow these instructions carefully may cause unreliable performance.



**CAUTION!** This symbol indicates a risk of potential minor personal injury and/or severe damage to the equipment, unless these instructions are followed carefully.



**WARNING!** This symbol indicates a risk of potential serious personal injury, unless these instructions are followed carefully.

## Safety Issues



**WARNING!** It is the responsibility of the user to make sure all local, county, state and national codes, regulations, rules and laws related to safety and safe operating conditions are met for each installation.



**Attention European Customers!** To meet CE Marking requirements for all units intended for use in the EU, all electrical cables must be installed as described in this manual.

## Auxiliary Equipment

### Local Safety Standards

The user must make sure that he operates all auxiliary equipment in accordance with local codes, standards, regulations, or laws applicable to safety.

### Working Area



**WARNING!** Auxiliary equipment may have both manual and automatic modes of operation. As equipment can move suddenly and without warning, do not enter the work cell of this equipment during automatic operation, and do not enter the work envelope of this equipment during manual operation. If you do, serious injury can result.



**WARNING!** Make sure that power to the auxiliary equipment is turned OFF and locked out before you perform maintenance procedures on this equipment.

## Qualification of Personnel

Make sure that all personnel have manufacturer-approved training applicable to the auxiliary equipment.

## Personal Safety Equipment

Make sure that operators and maintenance personnel have all safety equipment applicable to the auxiliary equipment. Examples include safety glasses, protective headgear, safety shoes, etc.

## Unauthorized Operation

Make sure that unauthorized personnel cannot gain access to the operation of the equipment.

## Environmental Compliance

### RoHS

The Model CTF878 Clamp-On Tag Flowmeter fully complies with RoHS regulations (Directive 2011/65/EU).

### Waste Electrical and Electronic Equipment (WEEE) Directive

Panametrics is an active participant in Europe's *Waste Electrical and Electronic Equipment (WEEE)* take-back initiative (Directive 2012/19/EU).

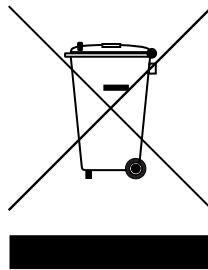

The equipment that you bought has required the extraction and use of natural resources for its production. It may contain hazardous substances that could impact health and the environment.

In order to avoid the dissemination of those substances in our environment and to diminish the pressure on the natural resources, we encourage you to use the appropriate take-back systems. Those systems will reuse or recycle most of the materials of your end life equipment in a sound way.

The crossed-out wheeled bin symbol invites you to use those systems.

If you need more information on the collection, reuse and recycling systems, please contact your local or regional waste administration.

## Certification and Safety Statements

Product safety issues and special installation requirements are documented in this product's Certification and Safety Statement (CSS) document, available for download from the Product Support Portal.

## EU Declaration of Conformity

The EU Declaration of Conformity (EU DoC) and other compliant documents can be downloaded from the Product Support Portal.

**Chapter 1.**

1.1 Features and Capabilities .....1  
 1.1.1 Overview .....1  
 1.1.2 Theory of Operation ..... 3

**Chapter 2.**

2.1 Install ..... 5  
 2.1.1 Introduction ..... 5  
 2.1.2 Unpacking ..... 5  
 2.1.3 System Parts ..... 5  
 2.1.4 Tools for Installation ..... 6  
 2.1.5 Installing the Electronics Console ..... 8  
 2.1.6 Installing Transducer Support ..... 10  
 2.1.7 Installing a CFT-V Clamping Fixture ..... 10  
 2.1.8 Installing a CFT-PI Clamping Fixture ..... 16  
 2.1.9 Applying DMP-3 Damping Material ..... 20  
 2.1.10 Installing the PDJ Pipe Damping Jacket ..... 23  
 2.1.11 Installing Transducers ..... 24  
 2.1.12 Installing Temperature and Pressure Transmitters ..... 32  
 2.1.13 PC Board Connections ..... 34  
 2.1.14 Option Card Wiring ..... 36

**Chapter 3.**

3.1 Initial Setup ..... 41  
 3.1.1 Introduction ..... 41  
 3.1.2 Powering Up ..... 41  
 3.1.3 Using the Screen ..... 42  
 3.1.4 Using the Keypad ..... 44  
 3.1.5 Programming Site Data ..... 46

**Chapter 4.**

4.1 Operation ..... 69  
 4.1.1 Introduction ..... 69  
 4.1.2 Displaying and Configuring Data ..... 69

**Chapter 5.**

5.1 Specifications ..... 81  
 5.1.1 Features ..... 81  
 5.1.2 General System Specifications ..... 82  
 5.1.3 System Electronics Specifications ..... 82  
 5.1.4 Transducer, Preamplifier and Fixture Specifications ..... 85  
 5.1.5 Pipe Specifications ..... 86

**Appendix A.**

A.1 CE Mark Compliance ..... 87  
 A.1.1 Introduction ..... 87  
 A.1.2 Wiring ..... 87  
 A.1.3 External Grounding ..... 87

**Appendix B.**

B.1 Data Records ..... 89  
 B.1.1 Option Cards Installed ..... 89  
 B.1.2 Initial Setup Data ..... 90





# Chapter 1.

## 1.1 Features and Capabilities

### 1.1.1 Overview

The Model CTF878 Clamp-On Tag Flowmeter represents one of the most technologically advanced flow measurement systems in the world. It measures the flow rate of acoustically conductive single-phase gases. Unlike most ultrasonic gas flowmeters, however, the CTF878 does not require the tapping of a pipe. It works with external clamp-on ultrasonic transducers that do not interfere with gas flow.

Just clamp the transducers to the pipeline, follow some simple acoustic damping guidelines, program a few meter settings, and start collecting flow data for months (or even years) with no maintenance.

The CTF878 represents a new level of capacity compared to previous gas clamp-on systems, in that it can measure flow rates up to and greater than 150 ft/sec (46 m/sec), and it is less susceptible than previous systems to cross-flow disturbances.

#### 1.1.1.1 Electronics Package

In addition to the built-in LCD display, the flowmeter provides the following:

1. Two 0/4–20mA isolated outputs with a 550  $\Omega$  maximum load.
2. Six additional slots available for any combination of the following I/O boards:
  - a. Analog outputs: Select up to three additional output boards, each with four isolated 0/4–20 mA outputs, 1 k $\Omega$  max. load
  - b. Analog inputs: Select up to three boards of one of the following types:
    - *Analog Input Board with two isolated 4–20 mA inputs and 24 V loop power*
    - *RTD Input Board with two isolated three-wire RTD inputs; span  $-148^{\circ}$  to  $662^{\circ}\text{F}$  ( $-100^{\circ}$  to  $350^{\circ}\text{C}$ ); 100  $\Omega$  Pt*
  - c. Totalizer/Frequency outputs: Select up to three Totalizer/Frequency Output Boards each with four outputs per board, 10 kHz max. All boards allow software-selectable functioning in two modes:
    - *Totalizer Mode: Pulse per defined unit of parameter (e.g., 1 pulse/ft<sup>3</sup>)*
    - *Frequency Mode: Pulse frequency proportional to magnitude of parameter (e.g., 10 Hz = 1ft<sup>3</sup>/hr)*

- d.** Alarm relays: Select up to two boards of one of the following types (see note below):
- *General purpose: Relay board with three Form-C relays; 120 VAC, 28 VDC max., 5 A max.; DC 30 W max., AC 60 VA.*
  - *Hermetically sealed: Relay board with three hermetically sealed Form-C relays; 120 VAC, 28 VDC max., 2 A max.; DC 56 W max., AC 60 VA.*

The CTF878 has the ability to store site data in files which can be accessed at a later time. Within the Main Menu, a set of forms (windows) asks you all the necessary setup information for a particular site. Once you complete answering the necessary questions, you simply save the information to a file. The CTF878 stores these files and other data in non-volatile memory, which retains the information even if power is off.

This flowmeter displays measurements in both numeric and graphical form on an EL-backlit, 240 x 200 pixel LCD graphic screen. The CTF878 also has the capability of logging 6,900 flow data points internally.

**Note:** *The CTF878 electronics operates only with specially designed Panametrics Sensing clamp-on ultrasonic transducers.*

### 1.1.1.2 Transducers

The transducers are like a loudspeaker and microphone system that uses ultrasonic acoustic waves to interrogate the flow. For the CTF878, the transducers are mounted on a clamping fixture.

- **TRANSDUCERS** - The transducers convert electrical energy into ultrasonic acoustic waves when on the transmit end (sending sound into the pipe), and convert the ultrasonic acoustic waves back to electrical energy when on the receive end (listening for the sound waves to arrive). In other words, they act like loudspeakers when transmitting the signal and like microphones when receiving it.
- **CLAMPING FIXTURE** - The clamping fixture provides mechanical support for the transducers and assures stable alignment for accurate measurement (see Table 1-1 below and Figure 1 on page 4).

Pipe Size, O.D.	Clamping Fixture
from 6 to 8 inches	CFT-V8
from 10 to 12 inches	CFT-V12
from 14 to 30 inches	CFT-PI

### 1.1.2 Theory of Operation

The CTF878 uses an ultrasonic flow pattern recognition technology called *Correlation Tag* flow measurement. *Correlation Tag* technology utilizes a total of four clamp-on ultrasonic transducers externally mounted on a pipe. The transducers are arranged in two pairs—one upstream and one downstream. The upstream and downstream pairs are each composed of one transmitter sending ultrasound in a continuous wave mode through the fluid to its receiver, forming an upstream and downstream interrogation path. The continuous wave signal is modulated by turbulence and local density variations that are characteristic of a moving gas. Thus, both sets of the received signal contain a unique turbulence signature of the flowing gas. The received ultrasonic signals are demodulated and processed through a correlation algorithm. With turbulent flow conditions, a distinct correlation peak is recorded, which reflects the time it took for the unique turbulence signature to travel past each ultrasonic interrogation path. Since the distance between each interrogation path is defined in the transducer set-up, the flow velocity is easily calculated by dividing distance by the time it took for the turbulence signature to pass between each interrogation path.

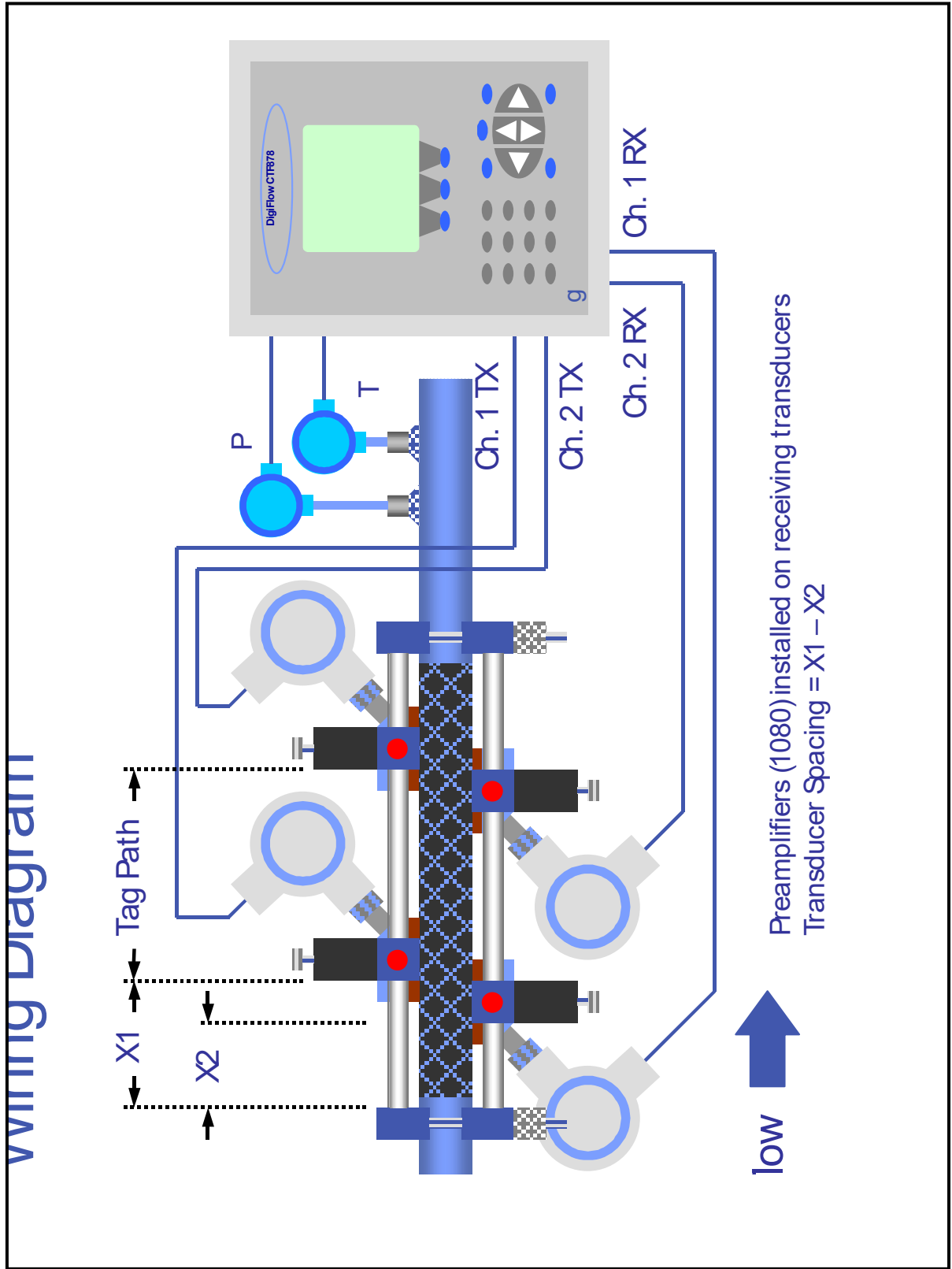

Figure 1: Typical CTF878 System Setup using a CFT-V Clamping Fixture

## Chapter 2.

### 2.1 Install

#### 2.1.1 Introduction

To ensure safe and reliable operation of the CTF878 Clamp-on Tag Flowmeter, the system must be installed in accordance with the guidelines set forth in this manual. Those guidelines, which are explained in detail in this chapter, include the following topics:

- Unpacking
- System Parts
- Tools for Installation
- Installing the Electronics Console
- Installing a CFT-V Clamping Fixture
- Installing a CFT-PI Clamping Fixture
- Installing Transducers
- Installing Temperature and Pressure Transmitters
- PC Board Connections
- Option Card Wiring

#### **WARNING!**

**The CTF878 flowmeter can measure the flow rate of many gases, some of which are potentially hazardous. In such cases, the importance of proper safety practices cannot be overemphasized.**

**Be sure to follow all applicable local safety codes and regulations for installing electrical equipment and working with hazardous gases or flow conditions. Consult company safety personnel or local safety authorities to verify the safety of any procedure or practice.**

#### **WARNING!**

**In order to meet CE Mark requirements, all wiring connections must be made in accordance with the instructions in Appendix A, *CE Mark Compliance*.**

#### 2.1.2 Unpacking

Carefully remove the electronics console, the clamping fixture, the transducers, the cables, and any other equipment ordered from the shipping containers (see Figure 2 on page 6). Before discarding any of the packing materials, account for all components and documentation listed on the packing slip. The discarding of an important item along with the packing materials is all too common. If anything is missing or damaged, contact the factory immediately for assistance.

#### 2.1.3 System Parts

The following is a list of parts required for a typical CTF878 system. Figure 2 below displays several system components.

- CTF878 Flowmeter
- Clamping Fixture
  - CFT-V8 for pipes between 6" and 8", or
  - CFT-V12 for pipes between 8" and 12", or
  - CFT-PI for pipes larger than 12"
- 2 Straps or Chains (to install a CFT-PI Clamping Fixture only)
- 4 Transducers
- 4 Conduit Boxes (2 with internal preamplifiers and 2 without)
- 4 Cables with integral BNC connectors (not shown)
- Damping Material (not shown)

- CPL-16 Couplant (not shown)

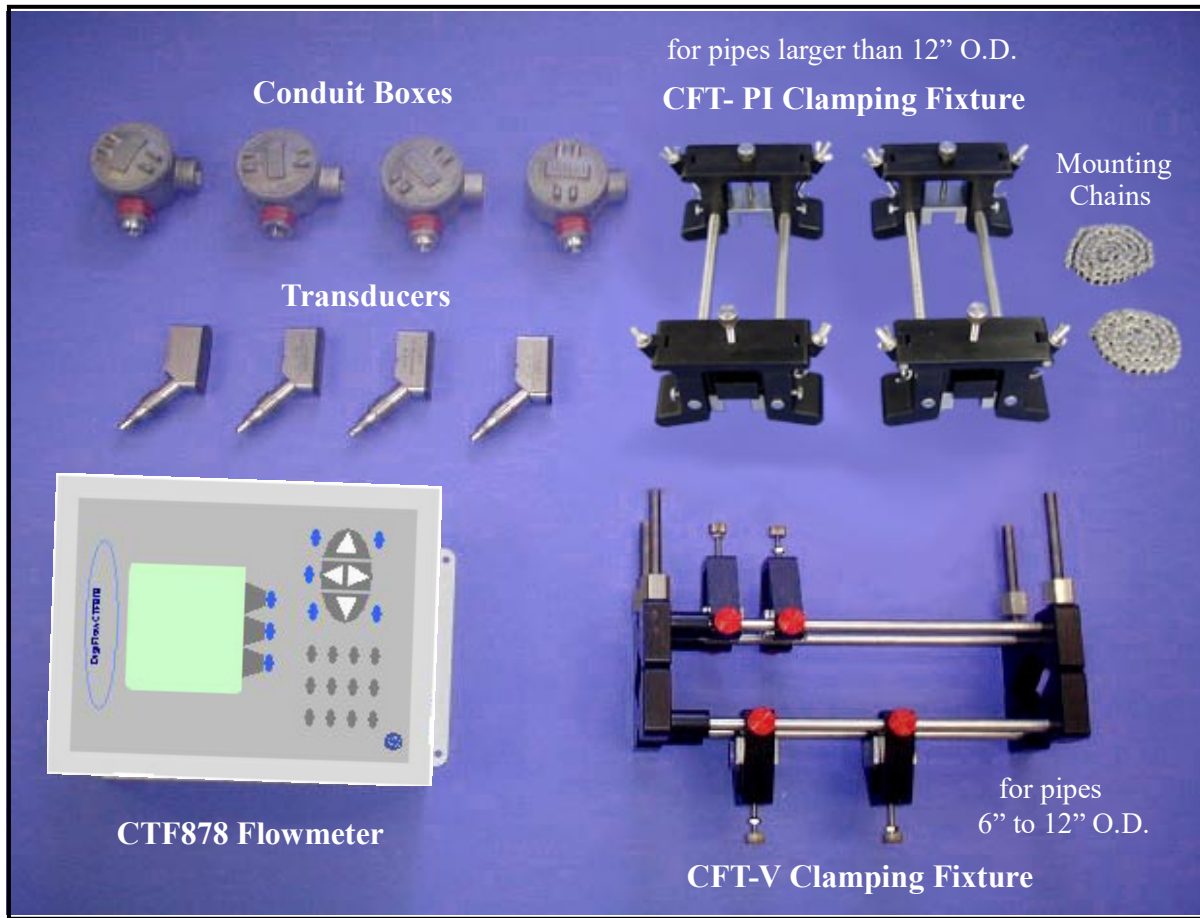

**Figure 2: Parts for a Typical CTF878 System**

### 2.1.4 Tools for Installation

Before you begin installing the *Model CTF878 Clamp-On Tag Flowmeter*, see Table 2-1 below for a list of required tools.

<b>Tool</b>	<b>Used:</b>
Multimeter	to check the voltage (if required).
Knife or Box Cutter	to cut the damping material to size.
Standard Screwdriver	to mount the electronics console, etc.
Phillips Screwdriver	to remove and replace the plastic shroud.
Wire Cutter	to cut cables and wires.
Wire Stripper	to prepare wires for TB connections.
Std. Screwdriver (miniature)	to connect the cable wires to terminal blocks.
Sandpaper	to smooth out the surface of pipe.
Cloth	to clean the surface of the pipe.
Tape Measure	to lay out fixture/transducers placement.

<b>Tool</b>	<b>Used:</b>
Felt-tipped Ink Marker	to mark the pipe for fixture/transducers placement.
Wall Thickness Gauge	to determine pipe wall thickness.
Adjustable Wrench	to install the clamping fixture.
Calipers	to measure the clamping fixture spacing (optional).

## 2.1.5 Installing the Electronics Console

Because the relative physical locations of the transducers and the CTF878 electronics console are important, use the guidelines which follow to plan the CTF878 system installation.

### 2.1.5.1 Locating the Electronics Console

The standard CTF878 electronics enclosure is a NEMA-4X weather-resistant, dust-tight, indoor/outdoor type. Typically, the electronics console is mounted in a meter shed. When choosing a mounting site, make sure that the location permits easy access to the console for programming, testing, and servicing.

**Note:** *For compliance with the European Union's Low Voltage Directive (2006/95/EC), this unit requires an external power disconnect device such as a switch or circuit breaker. The disconnect device must be marked as such, clearly visible, directly accessible, and located within 1.8 m (6 ft) of the CTF878.*

### 2.1.5.2 Mounting the Electronics Console

The standard CTF878 electronics package is housed in a NEMA-4X weather-resistant enclosure. Refer to Figure 24 on page 39 for the mounting dimensions of this enclosure.

#### **WARNING!**

**Proper grounding of the CTF878 chassis is required to prevent the possibility of electric shock. Use one of the mounting screws as an external ground connection (see Figure 25 on page 40).**

### 2.1.5.3 Wiring the Electronics Console

When making electrical connections to the CTF878 flowmeter, refer to Figure 25 on page 40 for a complete wiring diagram of the unit.

Except for the power connector, all electrical connectors are stored in their terminal blocks during shipment and may be removed from the enclosure for more convenient wiring. Feed the cables through the conduit holes on the bottom of the enclosure, attach the wires to the appropriate connectors and plug the connectors back into their terminal blocks.

**Note:** *For compliance with the European Union's Low Voltage Directive (2006/95/EC), a transparent plastic shroud protects the electrical connections. The shroud must remain in place, except while wiring the unit. Reinstall the shroud after the wiring has been completed.*



The CTF878 may be ordered for operation with power sources ranging from 85 to 264 VAC, at frequencies of 47 to 63Hz. The label on the shroud inside the electronics enclosure, just above the **TBI** line power terminal block, lists the required line voltage and the fuse rating for the unit (the fuse rating is also listed in Chapter 4, *Specifications*). Be sure to connect the meter only to the specified line voltage.

**Note:** For compliance with the European Union's Low Voltage Directive (2006/95/EC), this unit requires an external power disconnect device such as a switch or circuit breaker. The disconnect device must be marked as such, clearly visible, directly accessible, and located within 1.8 m (6 ft) of the CTF878.

Refer to Figure 25 on page 40 to locate the power input terminal block and connect the line power as follows:

**WARNING!**

**Improper connection of the line power leads, or connecting the meter to the incorrect line voltage, may damage the unit. It may also result in hazardous voltages at the clamping fixture and associated piping, and/or within the electronics console.**

1. Prepare the line power leads by trimming the line and neutral AC power leads (or the positive and negative DC power leads) to a length 0.5 in. (1 cm) shorter than the ground lead. This ensures that the ground lead is the last to detach if the power cable is forcibly disconnected from the meter.
2. Remove the plastic shroud that covers the terminal blocks.
3. Strip 1/4 in. of insulation from the end of each of the three line power leads.
4. Connect the line or positive (L or +) and the neutral or negative (N or -) power leads to the power input terminal block below the Main PC Board (see Figure 25 on page 40).
5. Connect the ground lead to the ground connection on the inside wall of the enclosure (see Figure 25 on page 40).
6. Reinstall the shroud after all of the wiring has been completed.

## 2.1.6 Installing Transducer Support

Since the CTF878 is specifically designed for gas measurement with clamp-on transducers, it requires the use of specially designed fixtures and damping material to maintain the highest possible measurement accuracy.

### 2.1.6.1 Clamping Fixture

Panametrics Sensing supplies the CFT series of fixtures:

- The V8 clamping fixture for pipes from 6 to 8 in. (100 to 200 mm).
- The V12 clamping fixture for pipes from 8 to 12 in. (200 to 300 mm).
- The PI clamping fixture for pipes from 12 to 24 in. (300 to 600 mm).

### 2.1.6.2 Damping Material

Panametrics Sensing strongly recommends applying DMP damping material in ALL permanent clamp-on applications to help eliminate signal noise. The material comes in two versions:

- The DMP-1 self-adhesive sheet for applications up to 200°F (93°C). The material comes as three wide sheets cut in sufficient length to wrap around a pipe OD. The material can be cut with a utility knife, and comes with a paper backing that is removed before installation.
- The DMP-3 is a clay-like compound for all temperature applications. If the temperature is over 150°F, the PDJ pipe damping jacket (available from the factory with preapplied DMP-3) must be used with the material.

## 2.1.7 Installing a CFT-V Clamping Fixture

For a given gas and pipe, the CTF878's accuracy depends primarily on the location and alignment of the transducers. To install the CFT-V transducer-supporting clamping fixture (for pipes 6" to 12" O.D.), use the following guidelines:

**Note:** *With a CFT-V clamping fixture, the damping material is installed prior to the fixture itself. To install a clamping fixture on pipes over 12", proceed to Installing the CFT-PI Clamping Fixture on page 16.*

### 2.1.7.1 Locating the CFT-V Clamping Fixture

1. Choose a section of pipe with unlimited access; for example, a long stretch of pipe that is above ground.

**Note:** *If the clamping fixture is to be mounted on an underground pipe, dig a pit around the pipe to facilitate installation.*

2. Locate the clamping fixture and transducers so that there are at least 20 pipe diameters of straight, undisturbed flow upstream and 10 pipe diameters of straight, undisturbed flow downstream from the measurement point. To ensure undisturbed flow, avoid the following:

- sources of turbulence in the gas such as valves, flanges, expansions and elbows
- swirl
- dips or low spots in which condensed gas may collect

3. For maximum transducer reliability, mount the clamping fixture in a location that is sheltered from ambient precipitation such as rain.

**Note:** *In order to shield the transducer installation from adverse acoustic effects related to rain, it may be necessary to erect a rain shroud over and around the pipe where the transducers are mounted.*

4. Because condensate or sediment at the bottom of the pipe may cause attenuation of the ultrasonic signal, set up the clamping fixture so that the transducers are on the side of a horizontal pipe, ideally at 0° horizontal (3 and 9 o'clock). Also make sure that the transducers will not be located on or near any pipe welds or seams.

**Note:** *Do not orient the transducers greater than ±60° from the horizontal axis. The transmit / receive pairs must be oriented 180° from each other. The Upstream / Downstream pairs must be transmitting in the same direction (parallel to each other).*

### 2.1.7.2 Preparing for CFT-V Clamping Fixture Installation

Before the CFT-V clamping fixture can be installed, the following procedures must be completed:

- the pipe surface sanded
- the transducer spacing and TAG path set
- the damping material applied to the pipe
- the yokes positioned on the fixture

#### ***Sanding the Pipe***

Using a grinding tool or sand paper, smooth out the sections of the pipe where the transducers will be installed. The best approach is to grind on both sides of the pipe an area the length of the clamping fixture and  $\pm 60^\circ$  from the plane where the transducers are intended to be installed. Grinding such a large area ensures that the transducers are installed on a smooth section after the pipe is covered with damping material.

#### ***Setting the Transducer Spacing and TAG path***

The following procedure can be easily done before installing the clamping fixture on the pipe. For a more detailed description of these steps, refer to *Programming Site Data* on page 46:

1. Power up the CTF878 flowmeter.
2. In the top-level menu, enter Program / Transducer to select the transducers used.
  - Proceed to Program / Pipe to enter the pipe characteristics: material, outside diameter and wall thickness.
3. Enter Program / Fluid to select the fluid inside the pipe.

The flowmeter then calculates the transducer spacing and suggests the TAG path. The user then goes to Program / Path where these two parameters are available. The TAG path can be overwritten if the user wants to use a value other than the one suggested by the flowmeter.

**IMPORTANT:** The TAG path set on the clamping fixture HAS to be the one displayed under Program / Path when the instrument is operating, otherwise the velocity output will be incorrect.

### **Applying DMP-1 Damping Material for a CFT-V Clamping Fixture**

**Note:** If DMP-3 damping material is being used, refer to Applying DMP-3 Damping Material on page 20. If the pipe temperature is over 150°F, a PDJ pipe damping jacket with DMP-3 damping material is required (see Installing the PDJ Damping Jacket on page 23).

The surface of the pipe should be covered with damping material. Three pieces of the material should be placed as follows: one between the ends of the CFT-V clamping fixture and one on either side of the fixture. Use the following instructions and Figure 3 on page 13:

**Note:** The damping material pieces come cut to size as follows:

Length = outside diameter of pipe X 3.25

Width = 15 inches for a CFT-V8 clamping fixture

19 inches for a CFT-V12 clamping fixture

1. Place the first piece of damping material at the flow velocity measurement section. Position the strip as shown in Figure 3.
2. Peel the protective layer of paper off the damping material from the top to approximately 3 inches down and apply the strip to the pipe, starting from the top.

**Note:** If too much of the paper layer is peeled off at one time, the damping material will be harder to handle and apply to the pipe without making air bubbles.

**IMPORTANT:** The damping material should adhere very tightly to the pipe.

3. Continue to peel off the paper and apply the damping material to the pipe 3 inches at a time. Pull on the strip during each application to assure a tight fit.
4. Before peeling off each new section of the paper layer, be sure the previously applied section of damping material adheres firmly to the pipe. Apply pressure to it with your hands, going from the previously applied to the newly applied section.

**Note:** The purpose of this operation is to avoid the presence of air bubbles between the damping material and the pipe.

When the user is done applying the damping material, there should be one layer of it around the pipe with a small overlap.

5. Visually inspect the pipe for the presence of air bubbles and wrinkles. Then apply pressure to any bubbles and wrinkles to eliminate them.
6. Repeat steps 2 through 5 to apply the two other strips of damping material on either side of the first, leaving about a two-inch gap between the strips.

**Note:** The brackets of the CFT-V clamping fixture will rest against the pipe in the two gaps between the strips of damping material (see Figure 14 on page 26).

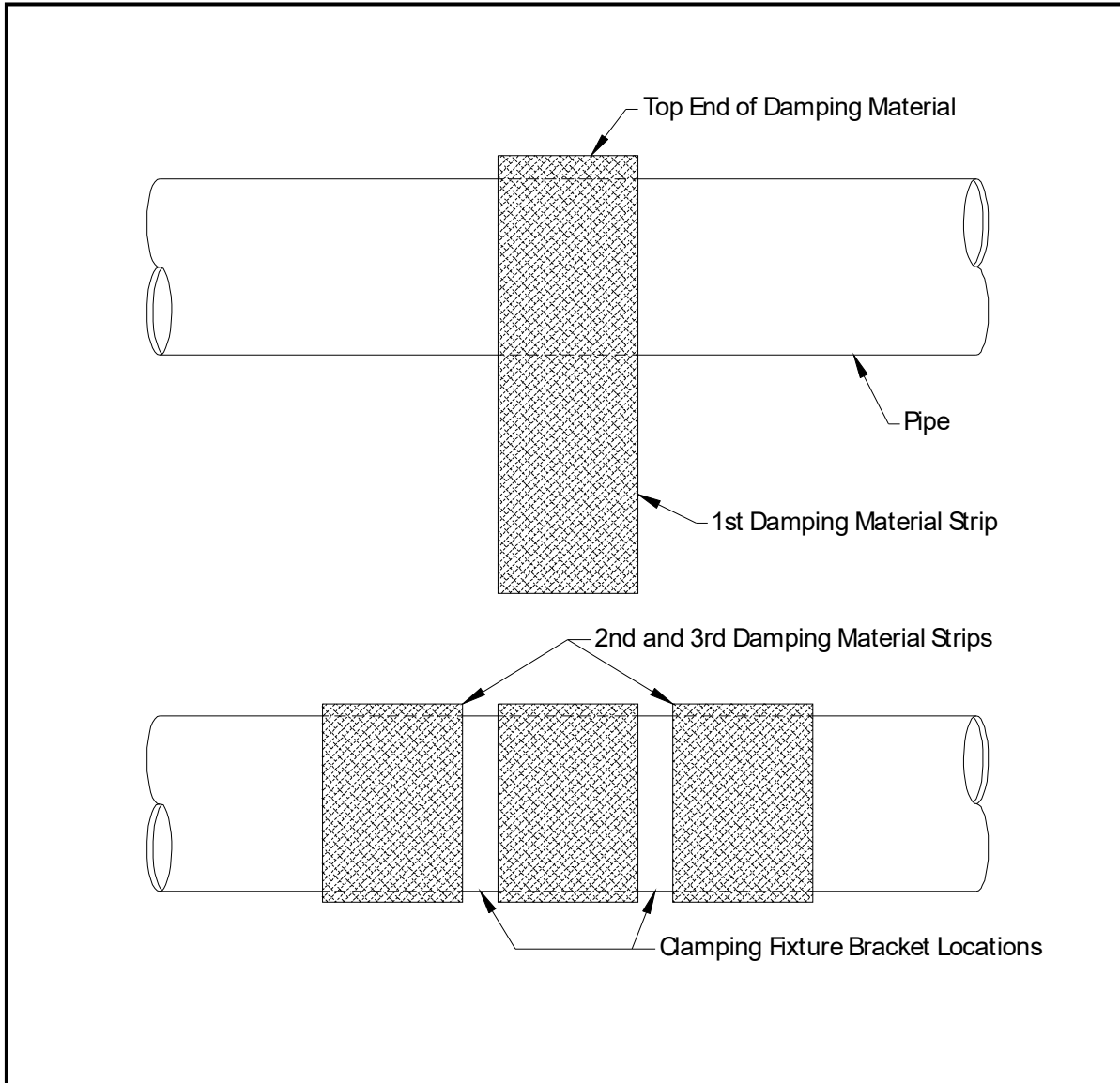

**Figure 3: Damping Material - Orientation and Application for CFT-V Fixtures**

### Positioning the Yokes

The CFT-V clamping fixture yokes are usually set in place at the factory, based on the information given at the time of the order. If it becomes necessary to reposition the yokes, proceed as follows:

1. Referring to Figure 4 below, set the first yoke at a short distance from the end bracket and tighten the yoke screw.
2. Using calipers, set the opposite yoke at a distance  $S$  from the opposite bracket and tighten the yoke screws.

**Note:** Distance  $S$  is equal to the distance of the first yoke from the end bracket plus the transducer spacing (see Setting the Transducer Spacing and TAG path on page 11).

3. Set the TAG path one side at a time and tighten the yoke screws before repeating this step for the other side.

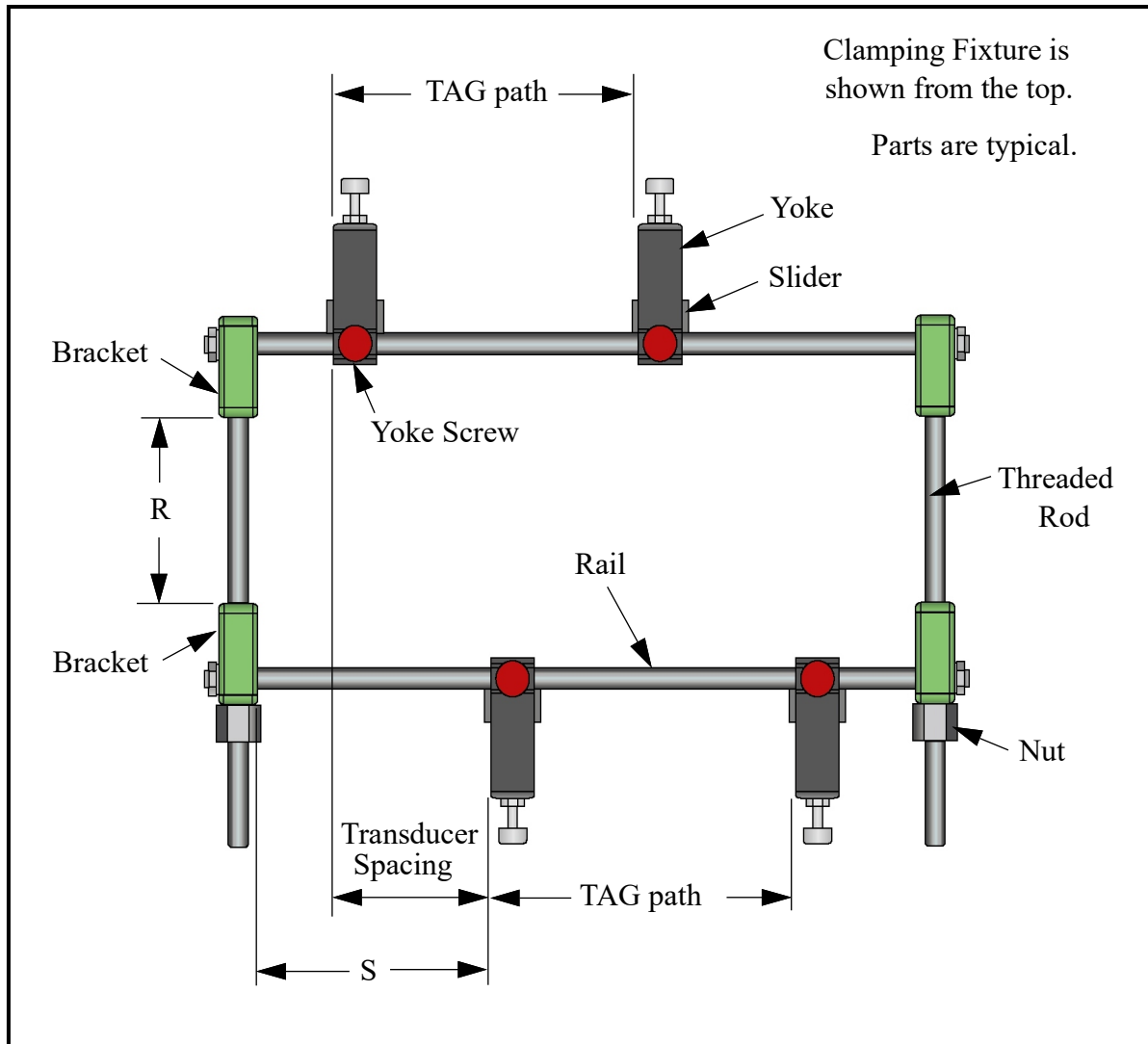

**Figure 4: CFT-V Clamping Fixture Setup**

#### 2.1.7.3 Mounting the CFT-V Clamping Fixture

Refer to Figure 4 on page 14 and mount the CFT-V clamping fixture on the pipe.

**IMPORTANT:** The measurement plane (the plane formed by the four transducers) should be horizontal or as close to horizontal as possible.

1. Place the clamping fixture on the pipe so that the brackets rest in the two gaps between the strips of damping material.

2. Thread the nuts on the ends of the threaded rods and lightly tighten them with a wrench.
3. Using a caliper, measure the four spacings (represented by R in Figure 4 on page 14) between the brackets and make sure that they are the same.

**Note:** To readjust the spacings between the brackets, work on one end of the fixture at a time.

4. If there is a need to readjust the spacings, loosen the nut on the smaller spacing rod, and tighten the nut on the bigger spacing rod.
5. Use the caliper again and check to see if the bottom and top spacings on one end are the same size.
6. After ensuring the gaps are the same size, repeat the process on the other end of the clamping fixture.

**WARNING!**

**Proper grounding of the clamping fixture (using the grounding lugs provided) is required, to prevent the possibility of electric shock and to meet CE Mark compliance.**

The CFT-V clamping fixture is now ready for transducer installation. Proceed to *Installing Transducers* on page 24.

## 2.1.8 Installing a CFT-PI Clamping Fixture

For a given gas and pipe, the CTF878's accuracy depends primarily on the location and alignment of the transducers. To install the CFT-PI clamping fixture (for pipes over 12" O.D.), use the following guidelines:

**Note:** *A CFT-PI clamping fixture should be installed before the damping material is applied to the pipe. To install a clamping fixture on pipes between 6" and 12" O.D., see Installing the CFT-V Clamping Fixture on page 10.*

### 2.1.8.1 Locating the CFT-PI Clamping Fixture

1. Choose a section of pipe with unlimited access; for example, a long stretch of pipe that is above ground.

**Note:** *If the clamping fixture is to be mounted on an underground pipe, dig a pit around the pipe to facilitate installation.*

2. Locate the clamping fixture and transducers so that there are at least 20 pipe diameters of straight, undisturbed flow upstream and 10 pipe diameters of straight, undisturbed flow downstream from the measurement point. To ensure undisturbed flow, avoid the following:

- sources of turbulence in the gas such as valves, flanges, expansions and elbows
- swirl
- dips or low spots in which condensed vapor or liquids may collect

3. For maximum transducer reliability, mount the fixture in a location that is sheltered from precipitation.

**Note:** *In order to shield the transducer installation from adverse acoustic effects related to rain, it may be necessary to erect a rain shroud over and around the pipe where the transducers are mounted.*

4. Because condensate or sediment at the bottom of the pipe may cause attenuation of the ultrasonic signal, set up the clamping fixture so that the transducers are on the side of a horizontal pipe, ideally at 0° horizontal (3 and 9 o'clock). Also make sure that the transducers will not be located on or near any pipe welds or seams.

**Note:** *Do not orient the transducers greater than  $\pm 60^\circ$  from the horizontal axis. The transmit / receive pairs must be oriented  $180^\circ$  from each other. The Upstream / Downstream pairs' must be transmitting in the same direction (parallel to each other).*

### 2.1.8.2 Preparing for CFT-PI Clamping Fixture Installation

Before the clamps can be installed, the following procedures must be completed:

- the pipe surface sanded
- the transducer spacing and TAG path set

#### **Sanding the Pipe**

Using a grinding tool or sand paper, smooth out the sections of the pipe where the transducers will be installed. The best approach is to grind on both sides of the pipe an area the length of the clamping fixture and  $\pm 60^\circ$  from the plane where the transducers are intended to be installed. Grinding such a large area ensures that the transducers are installed on a smooth section.

#### **Setting the Transducer Spacing and TAG path**

The following procedure can be easily done before installing the CFT-PI clamping fixture on the pipe. For a more detailed description of these steps, refer to *Programming Site Data* on page 46:

1. Power up the CTF878 flowmeter.
2. In the top-level menu, enter Program / Transducer to select the transducers used.
3. Proceed to Program / Pipe to enter the pipe characteristics: material, outside diameter and wall thickness.
4. Enter Program / Fluid to select the fluid inside the pipe.



The flowmeter then calculates the transducer spacing (S) and suggests the TAG path. The user then goes to Program / Path where these two parameters are available. The TAG path can be overwritten if the user wants to use a value other than the one suggested by the flowmeter.

**IMPORTANT:** The TAG path used to set up the CFT-PI clamping fixture HAS to be the one displayed under Program / Path when the instrument is operating, otherwise the velocity output will be incorrect.

### 2.1.8.3 Mounting the CFT-PI Clamping Fixture

Refer to Figure 5 below and Figure 6 on page 18 and mount the CFT-PI fixture on the pipe.

**IMPORTANT:** The measurement plane (the plane formed by the four transducers) should be horizontal (3 and 9 o'clock) or as close to horizontal as possible.

1. Using a pipe wrap and a felt-tipped ink marker, draw a first line around the pipe at the desired clamping fixture location.
2. Draw a second line around the pipe at a distance equal to the Transducer Spacing away from the first line.
3. Draw a third line around the pipe at a distance equal to the TAG path (which is 10 inches when using the CFT-PI clamping fixture) away from the first line.
4. Draw a fourth line around the pipe at a distance equal to the Transducer Spacing away from the third line.

The pipe should now look like Figure 5 below.

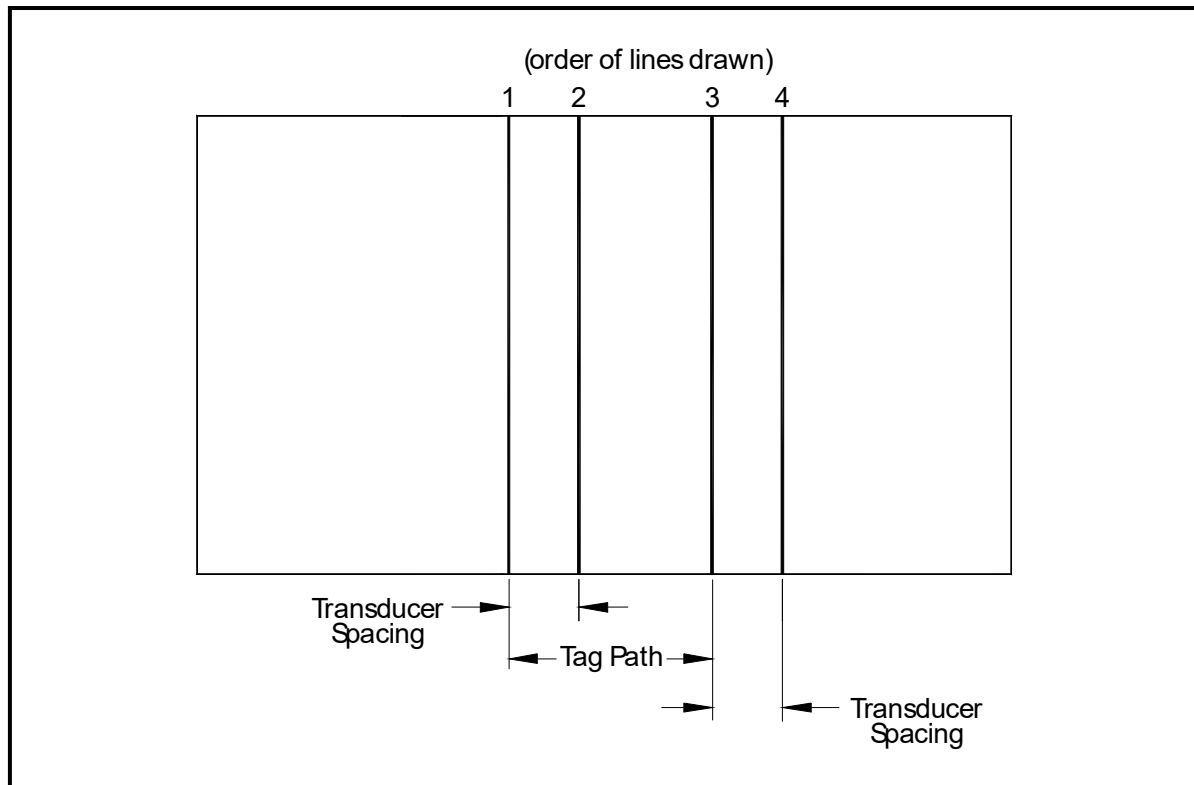
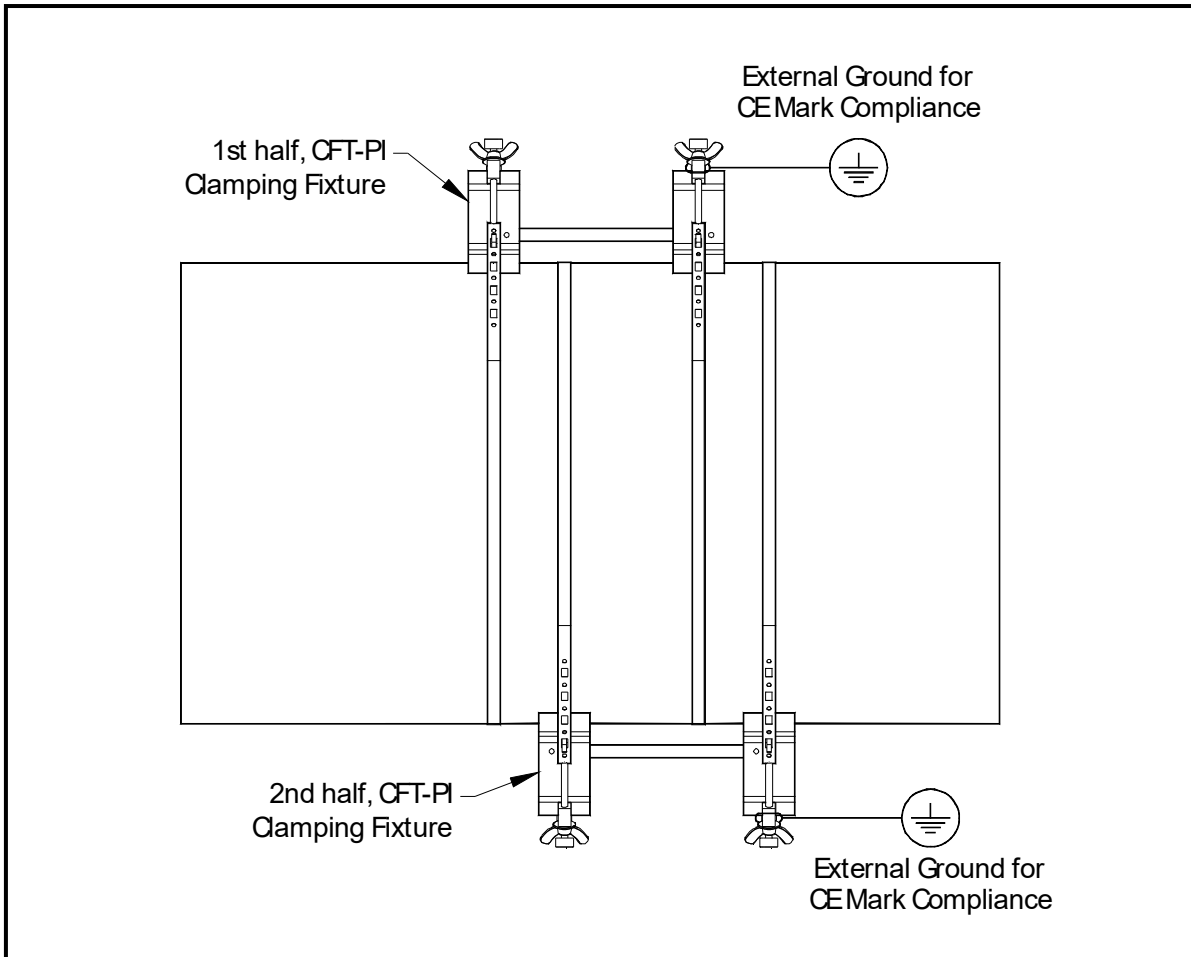

**Figure 5: CFT-PI Clamping Fixture, Lines Drawn for Installation**

5. Mount one half of the clamping fixture on one side of the pipe using the straps or chains provided. This half of the clamping fixture should align with the first and third lines drawn on the pipe.
6. Mount the other half of the fixture on the opposite side of the pipe. The clamping fixture should now look like Figure 6 below.

**WARNING!**

**Proper grounding of the clamping fixture (using the grounding lugs provided) is required, to prevent the possibility of electric shock and to meet CE Mark compliance (see Figure 6 below).**



**Figure 6: CFT-PI Clamping Fixture, Order of Installation (top view of pipe)**

#### 2.1.8.4 Applying DMP-1 Damping Material for a CFT-PI Clamping Fixture

**Note:** If DMP-3 damping material is being used, refer to Applying DMP-3 Damping Material on page 20. If the pipe temperature is over 150°F, a PDJ pipe damping jacket with DMP-3 damping material is required (see Installing the PDJ Damping Jacket on page 23).

The surface of the pipe should be covered with damping material. The three pieces of material should be placed as follows: one at each end of the fixture, and the third, cut into smaller pieces, and positioned between the straps or chains supporting the fixture. Use the following instructions and Figure 7 on page 20 as a guide:

**Note:** The damping material pieces come cut to size as follows:

Length = outside diameter of pipe X 3.25

Width = 10"

1. Place the first piece of damping material on one side of the fixture. Position the piece in the same way as the first damping material strip shown in Figure 3 on page 13.
2. Peel the protective layer of paper off the damping material from the top to approximately 3 inches down and apply the strip to the pipe, starting from the top.

**Note:** If too much of the paper layer is peeled off at one time, the damping material will be harder to handle and apply to the pipe without making air bubbles.

**IMPORTANT:** The damping material should adhere very tightly to the pipe.

3. Continue to peel off the paper and apply the damping material to the pipe 3 inches at a time. Pull on the strip during each application to assure a tight fit.
4. Before peeling off each new section of the paper layer, be sure the previously applied section of damping material adheres firmly to the pipe. Apply pressure to it with your hands, going from the previously applied to the newly applied section.

**Note:** The purpose of this operation is to avoid the presence of air bubbles between the damping material and the pipe.

When the user is done applying the damping material, there should be one layer of it around the pipe with a small overlap.

5. Visually inspect the pipe for the presence of air bubbles and wrinkles. Then apply pressure to any bubbles and wrinkles to eliminate them.
6. Repeat steps 1 through 5 for the second piece of damping material at the opposite end of the fixture.
7. Cut the third large piece of damping material into strips to fit between the two inside clamps (on opposite sides of the pipe) and between the straps or chains used to mount the clamps (see Figure 7 below).
8. Repeat steps 2 through 5 to apply each of the strips.

The CFT-PI clamping fixture is now ready for transducer installation. Proceed to *Installing Transducers* on page 24.

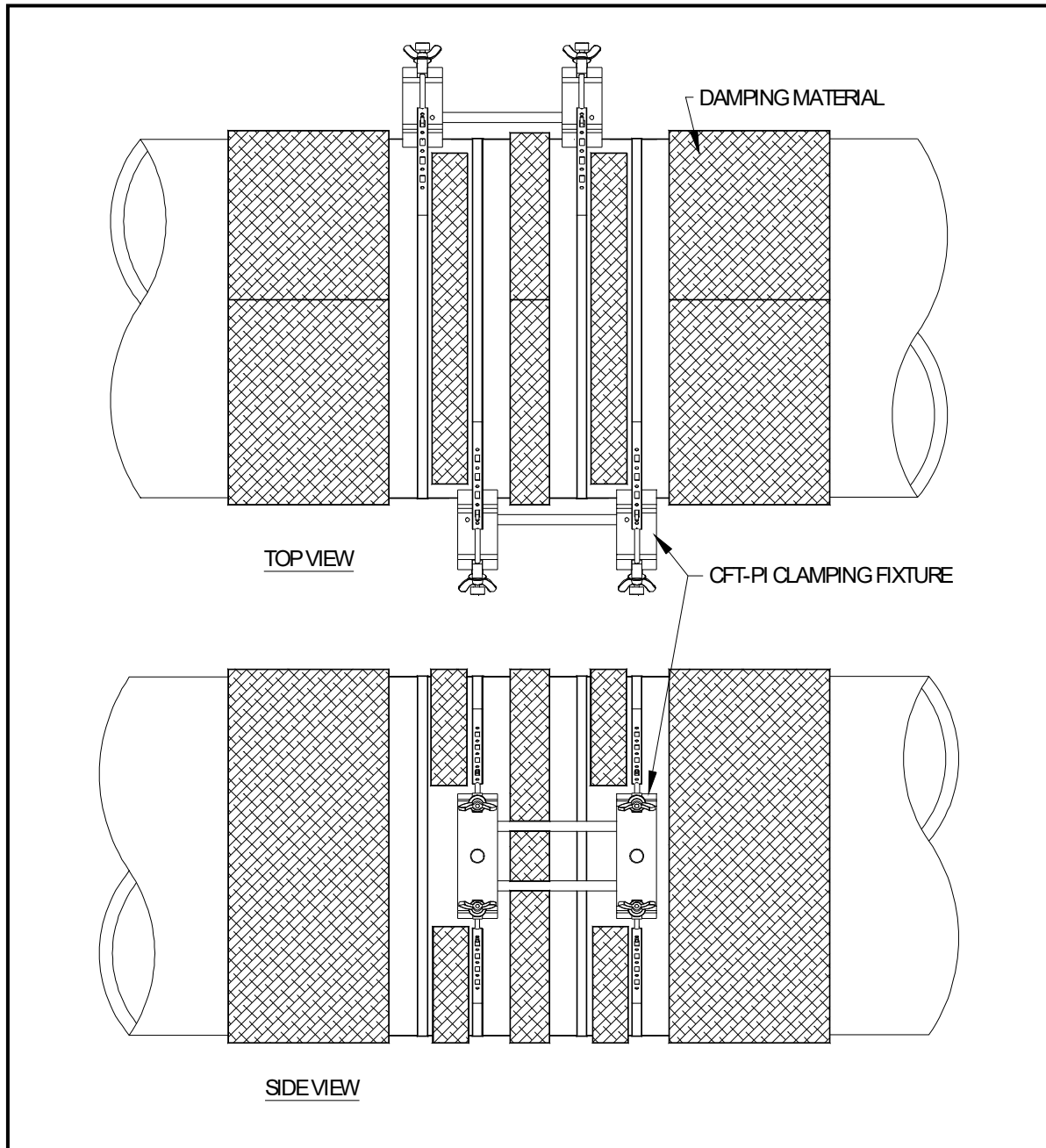

**Figure 7: Locating Damping Material with a CFT-PI Clamping Fixture Installed**

### 2.1.9 Applying DMP-3 Damping Material

For some applications, particularly on higher-temperature pipes, DMP-3 compound should be used.

**Note:** If the pipe temperature is over 150°F, a PDJ pipe damping jacket with DMP-3 damping material applied is required (see Installing the PDJ Damping Jacket on page 23).

#### **Preparing the Pipe**

To prepare the pipe for DMP-3 application:

1. Remove any loose paint or rust from the pipe surface with a file or emery cloth. If the finish is mirror-smooth, roughen the surface.

2. Mark the pipe to indicate the location of the clamping fixture and transducers (as in the previous sections, depending on the type of fixture being used).
3. While wearing appropriate gloves, degrease the pipe surface.

### ***Applying the DMP-3***

4. Place a piece of the DMP-3 material on top of the pipe, and use the palm of the hand to press it onto the pipe (see Figure 8 below).



**Figure 8: Applying DMP-3 Damping Material**

5. Spread the DMP-3 material so that it covers the whole area under the fixture, and 4 to 6 inches on both sides of the fixture, to a thickness of about 0.25 in. (6.4 mm), as shown in Figure 9 and Figure 10 on page 22.

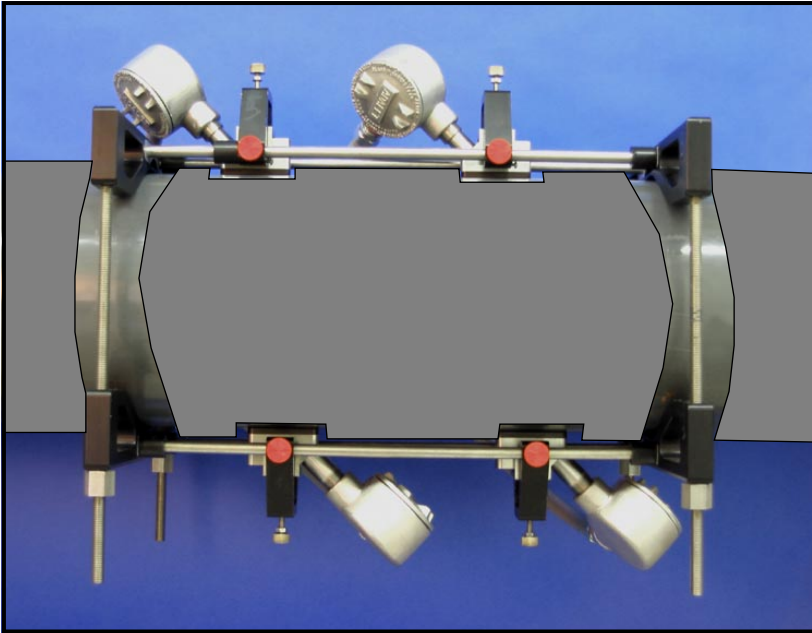

**Figure 9: Spreading DMP-3 Damping Material**

### ***Installing the Clamping Fixture***

6. Position the transducer yokes to the correct spacing and install the fixture around, but not on, the DMP-3 material.

7. Remove the DMP-3 material from the transducer locations (see Figure 10 below) and proceed to *Installing Transducers* on page 24.



**Figure 10: DMP-3 Damping Material with Fixture Installed**

### 2.1.10 Installing the PDJ Pipe Damping Jacket

If the pipe temperature is over 150°F, you must use a pipe damping jacket with preapplied DMP-3. The jacket is available in standard pipe sizes (see Table 2-2 and Figure 11 below) or in other sizes on special order.

Pipe Diameter	PDJ Part Number
6" (152mm)	583-145-06
8" (203mm)	583-145-08
10" (254mm)	583-145-10
12" (305mm)	583-145-12

\*If a pipe damping jacket other than those listed above is required,  
contact the factory for a special order.

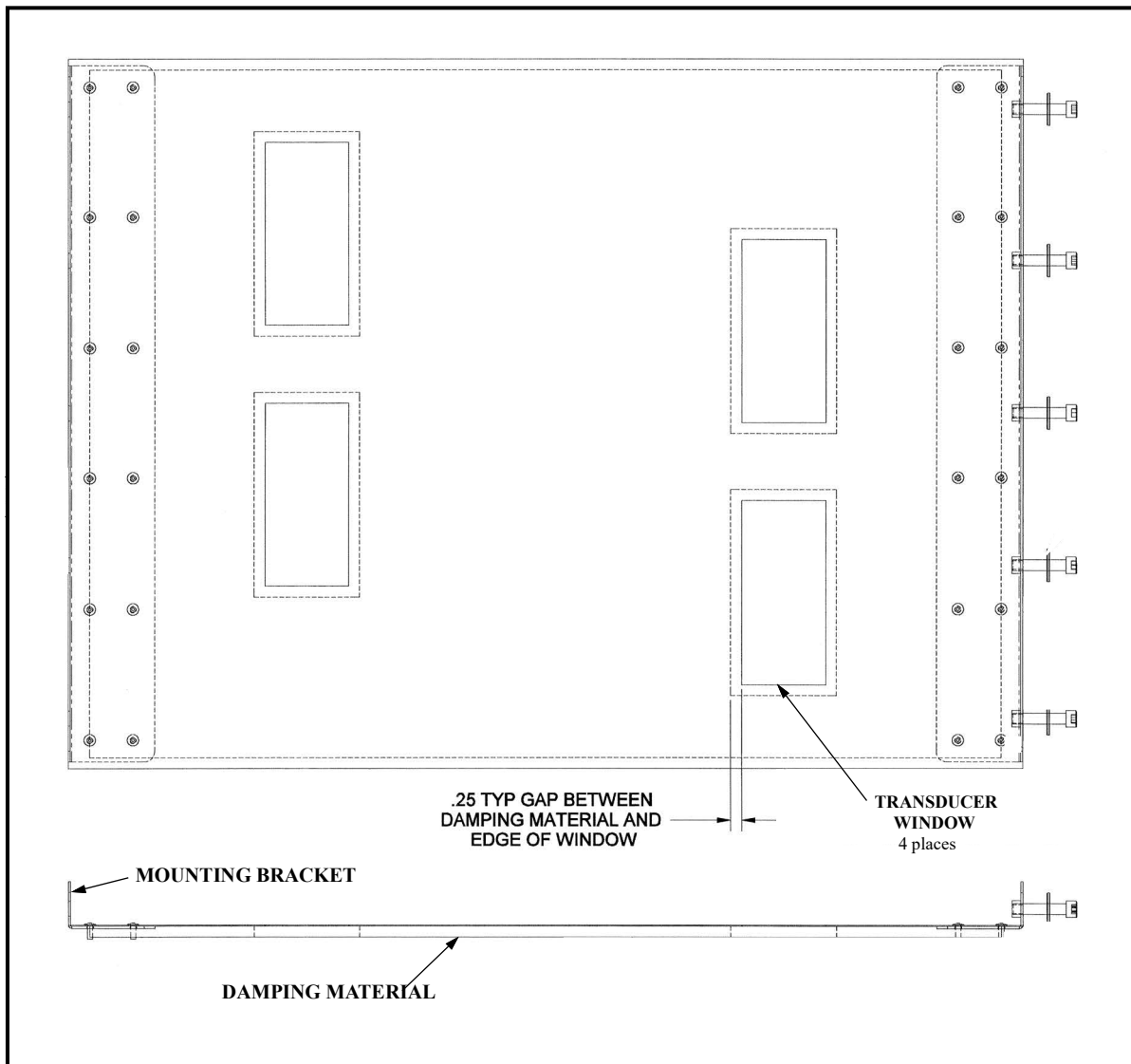

**Figure 11: PDJ Pipe Damping Jacket (Dwg. #583-145)**

1. Remove any insulation from the installation area, as well as any loose paint, rust and high spots from the pipe.
2. Remove the backing paper from the inside of the pipe damping jacket (shown in Figure 12 below).

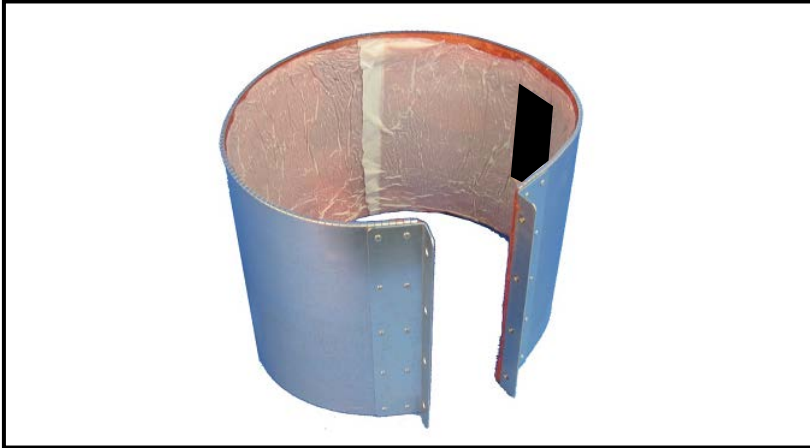

**Figure 12: Pipe Damping Jacket (cutouts not shown)**

3. Install the jacket on the pipe as shown in Figure 13 below. Align the cutouts with the previously marked transducer locations. Then tighten the clamping screws until some fluid drips from the bottom of the jacket.

**WARNING!**

**The pipe and the dripping fluid will cause severe burns upon contact with bare skin. Also, be sure not to inhale the fumes generated during the DMP-3 curing cycle.**

As the damping material dries (over several hours), its effectiveness increases. Proceed to *Installing Transducers* on page 24.

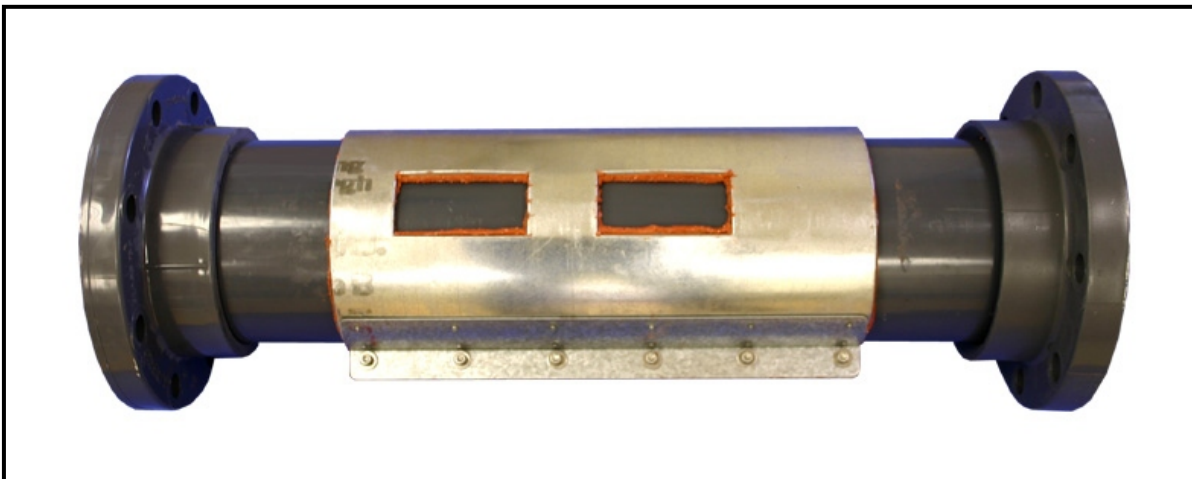

**Figure 13: Pipe Damping Jacket Installed**

## 2.1.11 Installing Transducers

For a given gas and pipe, the CTF878's accuracy depends primarily on the location and alignment of the transducers. Now that the clamping fixture is in place, use the following guidelines to install the four transducers. For detailed instructions on installing clamp-on transducers, refer to the supplied drawings and the Panametrics Sensing *Gas Transducer Installation Guide*. For CFT-V clamping fixtures, follow the steps below. For CFT-PI clamping fixtures, proceed to *Mounting Transducers* on page 26.

### 2.1.11.1 Preparing for Installation with a CFT-V Clamping Fixture

Before the transducers can be mounted on the pipe to transmit and receive signals effectively, a hole must be cut in the damping material at each transducer location. To complete this important step, proceed as follows:

1. Place a transducer in one of the sliders and tighten it down until it rests flat on the damping material.
2. Using a felt-tipped ink marker, draw the contour of the transducer's footprint on the damping material.



3. Remove the transducer from the slider and repeat steps 1 and 2 at the three other slider positions.
4. Using a knife or a box cutter, cut holes in the damping material along the contour lines of each transducer footprint.

**IMPORTANT:** The holes cut along the transducers' contour lines must be big enough to allow the entire footprint of each transducer to sit on the pipewall without any interference from the damping material.

**Note:** *This task may be difficult to complete because the yokes are partially in the way. If necessary, loosen the yoke screws and move the yokes.*

5. Using a solvent consistent with safety, disposal and cleaning requirements, clean the four areas of pipewall visible through the four holes in the damping material. Make sure there are no residues of damping material on these areas.

**Note:** *If the faces of the transducers are not free of residues, clean them using the same solvent.*

6. If you moved the yokes in step 4, remember to put them back to their exact positions before tightening the yoke screws.

**IMPORTANT:** You must use the caliper again to ensure that the transducer spacing and TAG path are correctly set.

### 2.1.11.2 Mounting Transducers

Prepare the transducers for mounting as follows:

1. Dispense a bead of CPL-16 couplant on the face of one transducer.
2. Take another transducer and rub the two transducer faces against one another so that the couplant spreads out on the entire face of each transducer.

**Note:** *The size of the bead of couplant dispensed on the first transducer should be enough, that in the end, there is a thin homogeneous coat of couplant on the faces of both transducers.*

3. Repeat these steps with the two remaining transducers.

If a CFT-V clamping fixture is being used, refer to Figure 14 below for transducer orientation and complete the following steps one transducer at a time. If a CFT-PI clamping fixture is installed, refer to Figure 7 on page 20 for transducer orientation and complete the following steps one transducer at a time.

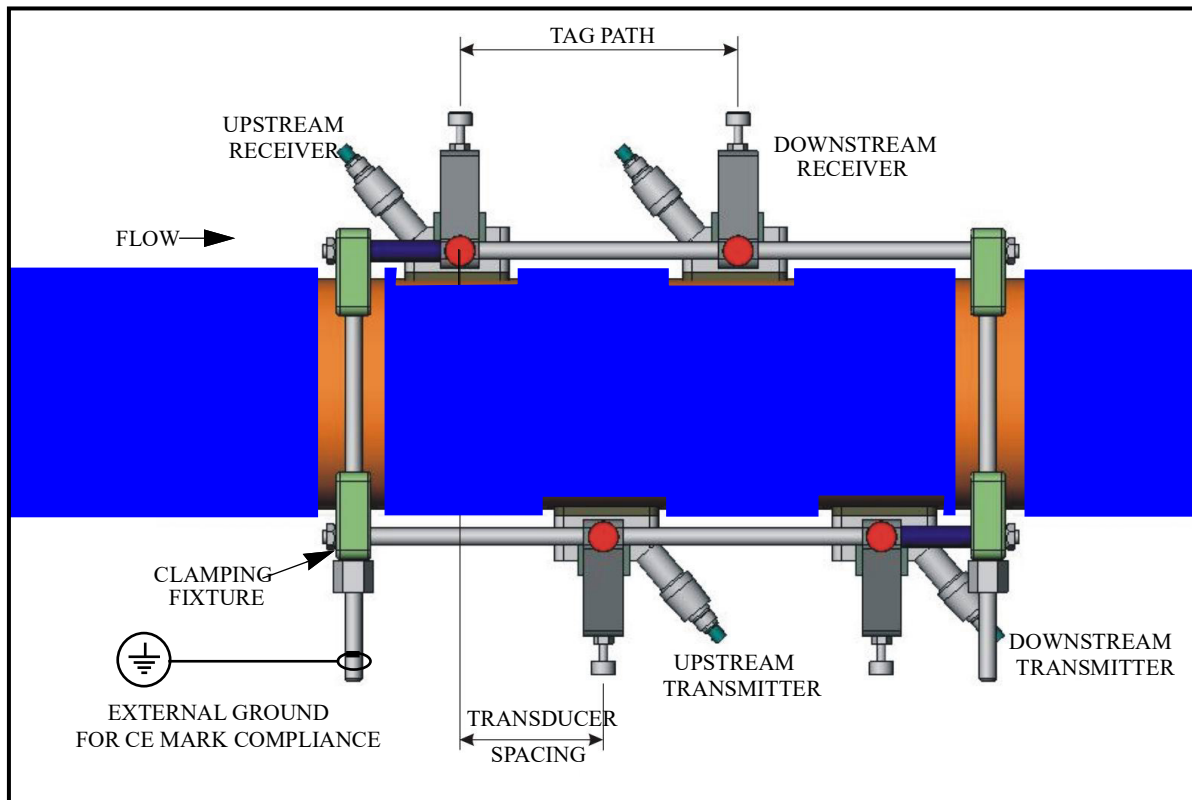

**Figure 14: Typical CFT-V Clamping Fixture / Transducer Setup (top view of pipe)**

4. Carefully position the transducer inside the clamping fixture's slider.

**Note:** *While doing this, make sure that none of the couplant gets wiped off of the transducer's face. The best way to prevent this is to hold the transducer by the stem and keep its face parallel to the pipe wall at all times.*

5. While holding the transducer against the back of the slider and parallel to the pipe wall, tighten it down until it is in contact with the pipe wall.
6. Apply a finger-tight torque until the transducer stops moving inside the slider.

**CAUTION!**

**If excessive torque is applied, the face of the transducer may be damaged.**

7. Repeat steps 4 through 6 for the remaining three transducers.

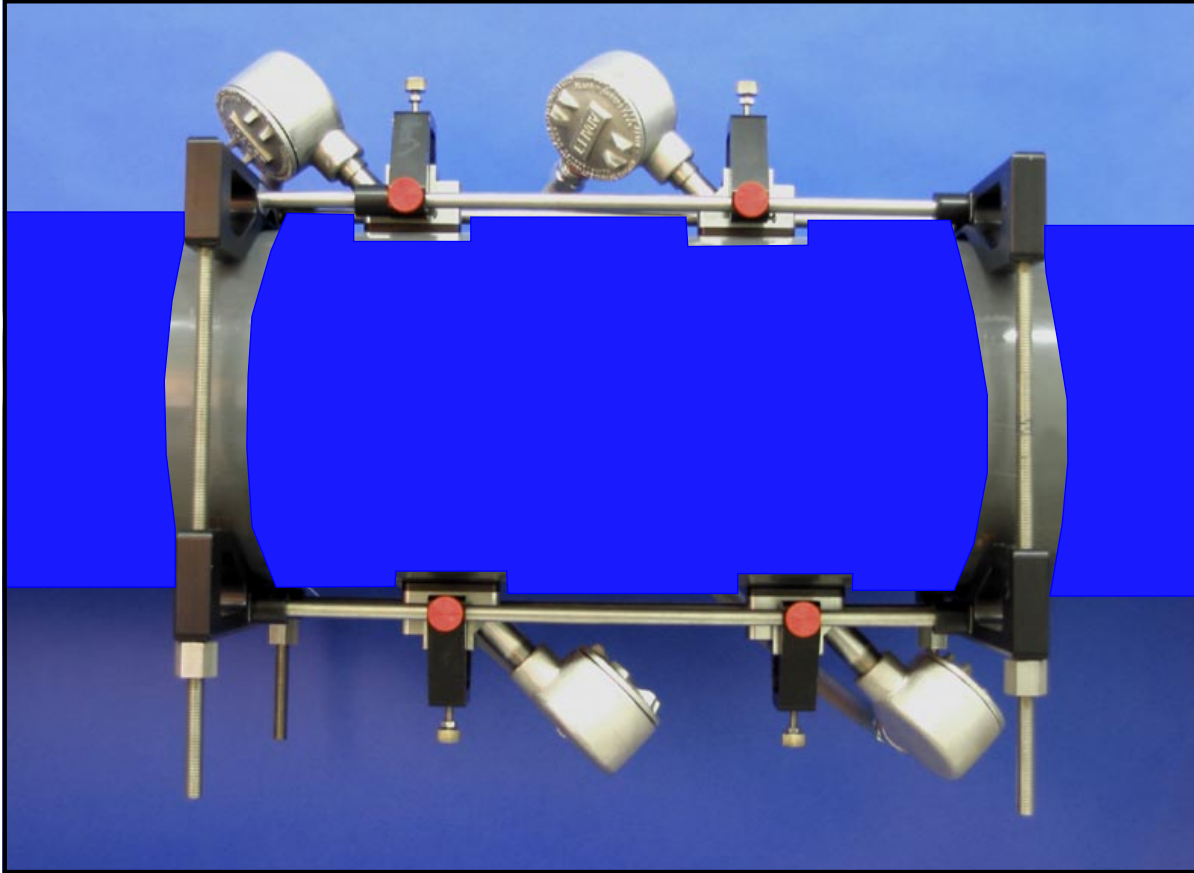

**Figure 15: CFT-V Clamping Fixture with Transducers and Conduit Boxes Installed**

### 2.1.11.3 Wiring the Transducers

The user must know the direction of the flow since it will dictate how to connect the transducers to the flowmeter (refer to Figure 18 on page 31 for transducer wiring).

#### **Identifying the Transducers**

The transducers must be connected so that the flow direction is from the Upstream pair of transducers to the Downstream pair of transducers. A pair of transducers is made up of a Receiver and a Transmitter (see Figure 14 on page 26 for a CFT-V fixture installation or Figure 7 on page 20 for a CFT-PI installation).

In a pair of transducers, the Transmitter must be downstream of the Receiver. Basically, along the axis of the pipe, the Transmitter sends a signal opposite the direction of the flow.

#### **Making Cable Connections**

Panametrics Sensing supplies transducer cables up to 500 ft (153 m) in length. If longer cables are required, consult the factory for assistance.

When installing the transducer cables, always observe established standard practices for the installation of electrical cables. Specifically, do not route transducer cables alongside high-amperage AC power lines or any other cables that could cause electrical interference. Also, protect the transducer cables and connections from the weather and corrosive atmospheres.

**Note:** *If non-Panametrics Sensing cables are being used to connect the flowmeter transducers to the CTF878 electronics console, they must have electrical characteristics identical to the Panametrics Sensing cables. Type RG 62 a/u coaxial cable should be used, and each cable must be the same length (within  $\pm 4$  in.).*

Figure 1-1 on page 1-4 shows a typical CTF878 system. For detailed instructions on installing clamp-on transducers, refer to the supplied drawings and the Panametrics Sensing *Gas Transducer Installation Guide*.

**WARNING!**

**Proper grounding of the clamping fixture (using the grounding lugs provided) is required, to prevent the possibility of electric shock and to meet CE Mark compliance.**

Wiring a typical CTF878 ultrasonic gas flowmeter system requires interconnection of the following components:

- four transducers (two upstream and two downstream)
- two preamplifiers (one for the upstream receiver and one for the downstream receiver)
- the electronics console

**IMPORTANT:** For the flowmeter system to function correctly, the CTF878 receiver board frequency range must match that of the transducers being used. To check, compare the labels on the electronics console and on the transducers. Default frequency ranges include:  
1MHz / 888kHz, 500kHz / 471kHz, 250kHz / 222kHz

Refer to Figure 18 on page 31 and complete the following steps:

**WARNING!**

**Before connecting the transducers, take them to a safe area and discharge any static buildup by shorting the center conductor of the transducer cables to the metal shield on the cable connector.**

1. Using a pair of coaxial cables with BNC to BNC connectors (supplied by the factory or equivalent), connect the two transmitter transducers to connectors TX1 (Upstream Transmitter) and TX2 (Downstream Transmitter) in the electronics console (see Figure 17 on page 30).

**CAUTION!**

**As part of maintaining the environmental rating (NEMA/TYP 4) on the remote preamplifier, thread sealant is required on all conduit entries.**

2. Using a second pair of BNC to BNC coaxial cables, connect the preamplifiers (attached to the receiver transducers) to RX1 (Upstream Receiver) and RX2 (Downstream Receiver) in the electronics console (refer to Figure 16 and Figure 17 on page 30).

After the wiring has been completed, the transducer channels must be programmed before measurements can begin. See Chapter 3, *Initial Setup*, for instructions.

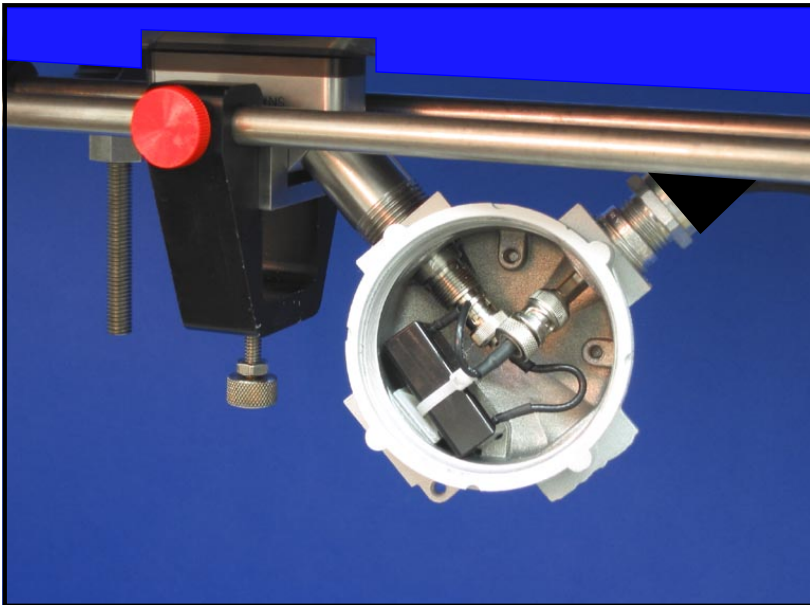

**Figure 16: Receive Transducer with Preamplifier**

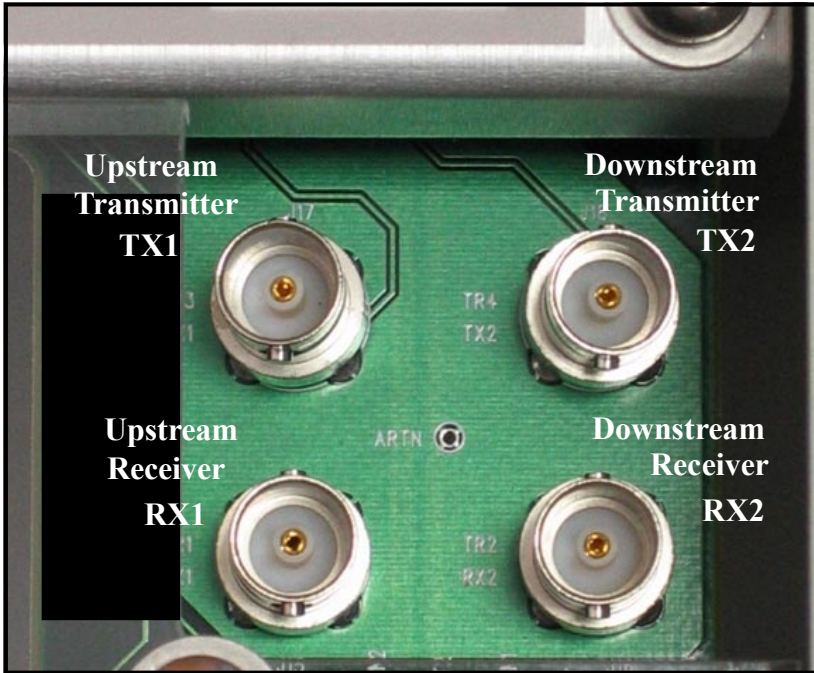

**Figure 17: Transducer Connections - Main PC Board**

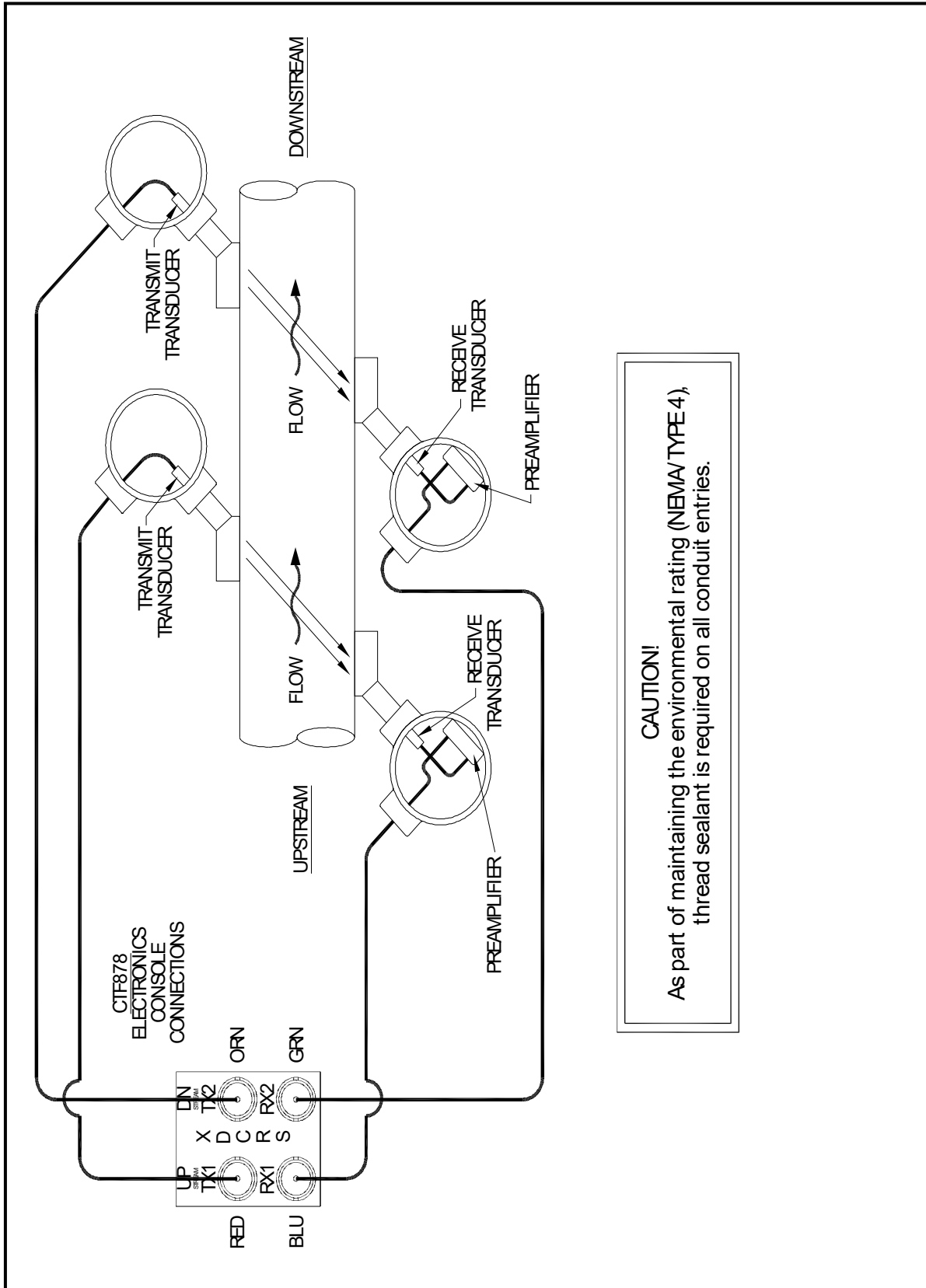

Figure 18: CTF878 - Transducer Wiring

## 2.1.12 Installing Temperature and Pressure Transmitters

Temperature and pressure transmitters are usually not required with the CTF878 system, but may be installed for standard volumetric or mass flow determination.

**IMPORTANT:** Under changing temperature and pressure conditions, the CTF878 can calculate standard volumetric flow accurately only if temperature and pressure transmitters have been installed.

### 2.1.12.1 Locating

Temperature and pressure transmitters should be positioned downstream of the clamp-on fixture / transducers, no closer than two pipe diameters and no further away than twenty pipe diameters.

### 2.1.12.2 Mounting

Typically, a 1/2" NPT female threaded port is used to mount the transmitters on the pipe. If the pipeline is insulated, the coupling may need to be extended to provide convenient access. Of course, other types of mounting ports, including flanged ports, may be used for the transmitters.

Figure 19 below shows a typical mounting arrangement for the pressure and temperature transmitters. The temperature sensor should protrude 1/4 to 1/2 way into the pipe.

### 2.1.12.3 Wiring

These transmitters must use a 0/4–20 mA signal to transmit the temperature and pressure values to the CTF878 electronics console. In turn, the electronics console will provide a 24 VDC signal to power the transmitters. Any transmitters or sensors that are used must have an accuracy equal to 0.5% of the reading or better.

**Note:** Resistive Thermal Devices (RTDs) are a good choice for measuring the temperature.

To wire the transmitters, refer to Figure 20 on page 33.

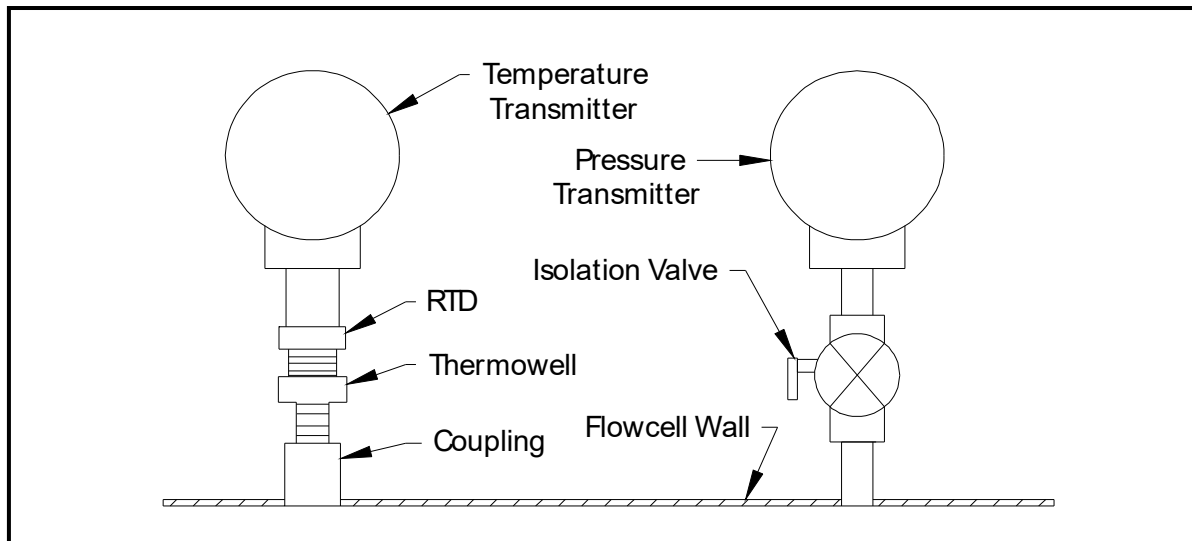

**Figure 19: Typical Temperature/Pressure Transmitter Mounting**



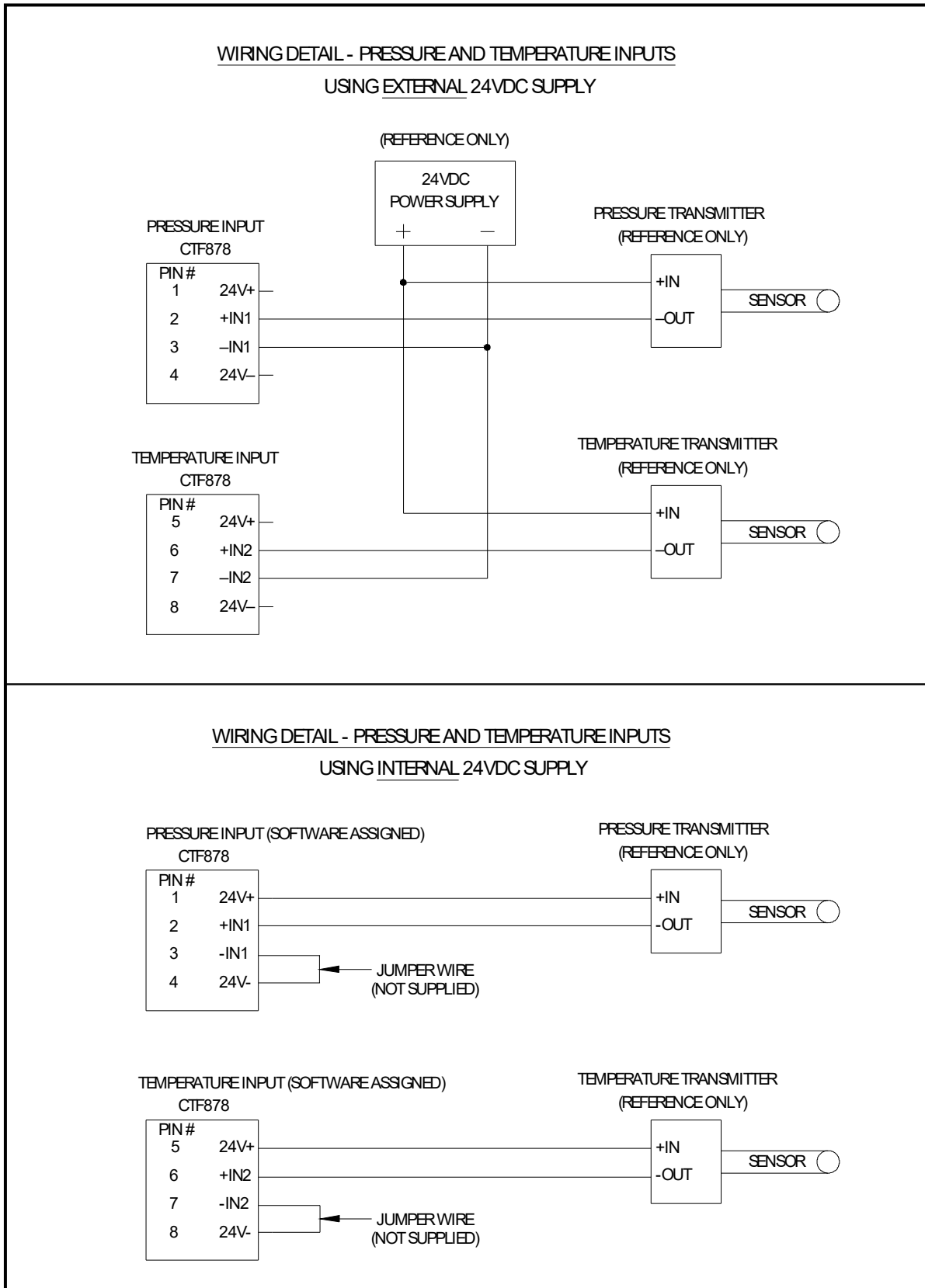

**Figure 20: Temperature & Pressure Transmitter Connections to Input Option Cards**

## 2.1.13 PC Board Connections

### 2.1.13.1 Wiring the 0/4–20 mA Analog Outputs

The standard configuration of the CTF878 flowmeter includes two isolated 0/4–20 mA analog outputs (designated as 1 and 2). Connections to these outputs may be made with standard twisted-pair wiring. The current loop impedance for these circuits must not exceed 550 ohms. Refer to Figure 25 on page 40 for the location of the Analog Output terminal block and wire the terminal block as shown.

### 2.1.13.2 Wiring the Serial Port

The CTF878 is equipped with a built-in serial communications port. The standard port is an RS232 interface, but an optional RS485 interface is available upon request. Proceed to the appropriate sub-section for wiring instructions. For more information on serial communications, refer to the *EIA-RS Serial Communications Manual* (916–054).

#### **Wiring the RS232 Interface**

The RS232 serial communications port may be used for connecting the CTF878 flowmeter to a personal computer. The RS232 serial interface is wired as Data Terminal Equipment (DTE), and the signals available at the flowmeter's **RS232** Serial Port terminal block are shown in Table 1 below. Refer to Figure 25 on page 40 to locate terminal block **RS232** and complete the following steps to wire the terminal:

1. Use the information in Table 1 below to construct a suitable cable for connecting the CTF878 to the external device. If desired, an appropriate cable may be purchased from the factory.

**Table 1: RS232 Connections to a PC (DCE Device)**

RS232 Pin #	Signal Description	DCE DB9 Pin #
1	RTN (Return)	5
2	TX (Transmit)	2
3	RX (Receive)	3
4	DTR (Data Terminal Ready)	4
5	CTS (Clear to Send)	7

2. Disconnect the main power to the unit and open the cover on the electronics enclosure. Remove the plastic shroud to access the serial communication connector.
3. Wire the flying leads end of the cable to terminal block **RS232** and connect the other end of the cable to the printer, ANSI terminal or personal computer.

4. Replace the plastic shroud, close the cover on the electronics enclosure and reconnect the main power to the unit.
5. Before initializing communication between the CTF878 and the personal computer, enter the Meter/Communications option and ensure that the CTF Communications settings match the settings of the personal computer.

### ***Wiring the RS485 Interface***

Use the optional RS485 serial port to network multiple CTF878 flowmeters to a single computer terminal.

To wire the RS485 serial port, complete the following steps:

1. Disconnect the main power to the unit and open the cover on the electronics enclosure. Remove the plastic shroud to access the serial communication connector.
2. Use the information in below to connect the CTF878 to the personal computer.

**Table 2: RS485 Connections**

<b>RS232 Pin #</b>	<b>Signal Description</b>
1	Shield
2	Transmit Data (RS485+)
3	Receive Data (RS485-)

3. After the wiring has been completed, replace the plastic shroud, close the cover on the electronics enclosure and reconnect the main power to the unit.

## 2.1.14 Option Card Wiring

### 2.1.14.1 Wiring an Alarms Option Card

The CTF878 flowmeter can accommodate up to 4 alarm option cards. Each alarms option card includes three *Form C relays* (designated as A, B and C).

The alarm relays on the option card are available in two types:

- general purpose
- hermetically sealed for Class I, Division 2 hazardous areas.

The maximum electrical ratings for the relays are listed in Chapter 4, *Specifications*. Each of the three alarm relays can be wired either as *Normally Open (NO)* or *Normally Closed (NC)*.

In setting up an alarm relay, it may be wired for either *conventional* or *fail-safe* operation. In fail-safe mode, the alarm relay is constantly energized, except when it is triggered by a power failure or other interruption. See Figure 21 below for the operation of a NO alarm relay in both conventional and fail-safe mode.

Connect the two wires required for each alarm relay in accordance with the pin number assignments shown in Figure 25 on page 40.

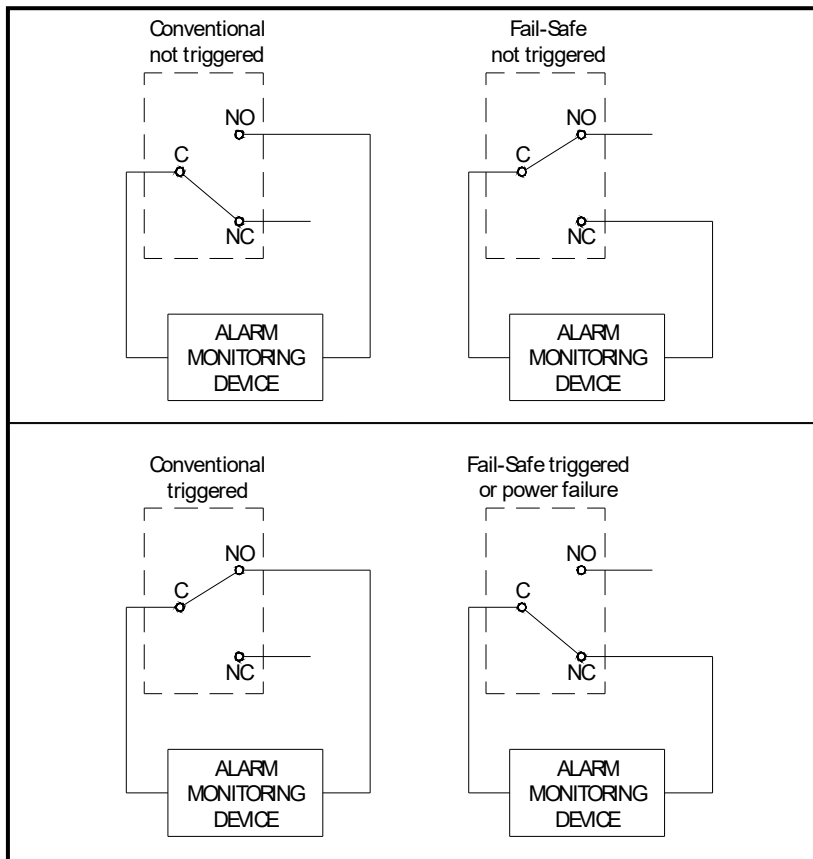

**Figure 21: Conventional and Fail-Safe Operation**

### 2.1.14.2 Wiring a 0/4-20 mA Analog Inputs Option Card

To calculate the standard volumetric flow rate of natural gas, the CTF878 requires accurate *temperature* and *pressure data* from the measurement site. Transmitters installed on the pipe can provide this information via an optional 0/4-20 mA analog inputs card. This option card includes two isolated 0/4-20 mA analog inputs (designated as A and B), each of which includes a 24 VDC power supply for loop-powered transmitters. Either input may be used to process the temperature signal, while the other input is used to process the pressure signal.

**Note:** To enter programming data during operation of the meter, it will be necessary to know which input is assigned to which process parameter. This information should have been entered in Appendix B, Data Records.

The analog inputs, which have an impedance of 118 ohms, should be connected with standard twisted-pair wiring. Power to the transmitters may be supplied either by the integral 24 VDC power supply on the analog input card or by an external power supply. Figure 22 below shows typical wiring diagrams, with and without an external power supply, for one of the analog inputs.

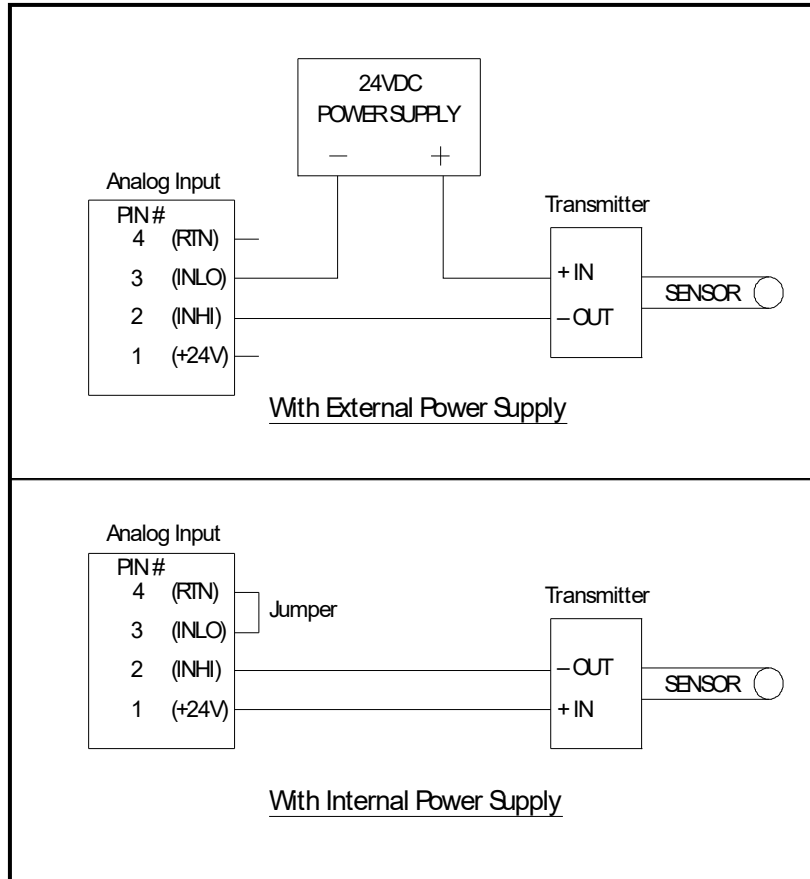

**Figure 22: Analog Input Wiring Diagram**

Wire the analog input terminal block in accordance with the pin number assignments shown in Figure 25 on page 40.

If the flowmeter system includes additional transmitters, the CTF878 can accommodate up to three more analog inputs option cards. These option cards are identical to the temperature/pressure card described above and they should be wired in the same manner (see Figure 22 on page 37).

The analog inputs on the option card(s) can be calibrated with the CTF878's built-in analog outputs. However, be certain that the analog outputs have been calibrated first. See Chapter 1, *Calibration*, in the *Service Manual* for the appropriate procedures.

### 2.1.14.3 Wiring a Totalizer/Frequency Outputs Option Card

The CTF878 can accommodate up to four totalizer/frequency outputs option cards. Each totalizer/frequency outputs option card provides four outputs (designated as A, B, C, and D) that can be used as either totalizer or frequency outputs.

Each totalizer/frequency output requires two wires. Wire this terminal block in accordance with the pin number assignments shown in Figure 25 on page 40. Figure 23 below shows sample wiring diagrams of a totalizer output circuit and a frequency output circuit.

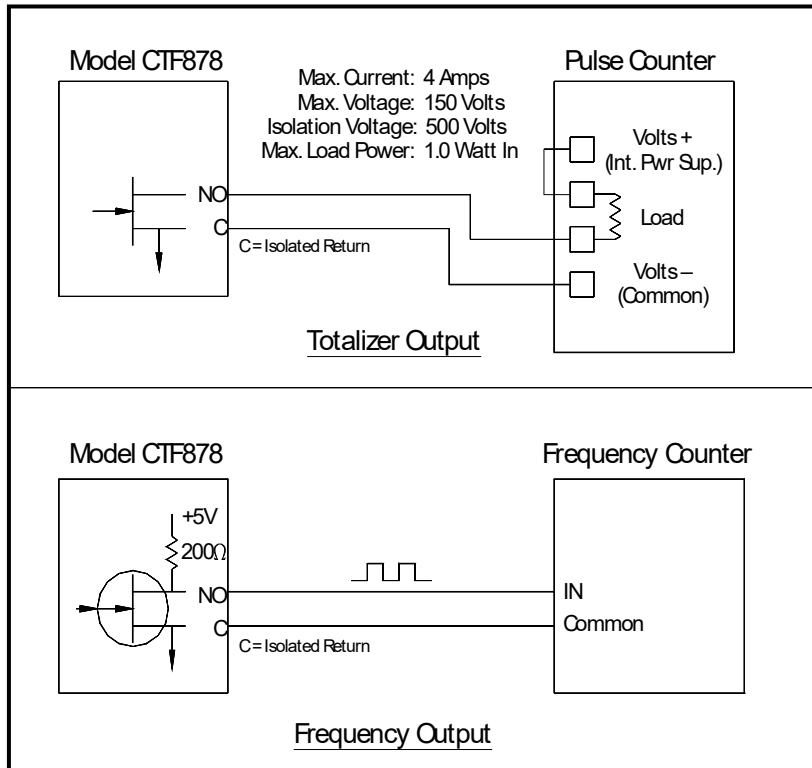

**Figure 23: Totalizer/Frequency Outputs Wiring**

#### 2.1.14.4 Wiring an RTD Inputs Option Card

The CTF878 can accommodate up to four RTD (Resistance Temperature Device) inputs option cards. Each RTD inputs option card provides two direct RTD inputs (designated as A and B).

Each RTD input requires three wires, which should be fed through one of the conduit holes on the bottom of the electronic console. Wire this terminal block in accordance with the pin number assignments shown in Figure 25 on page 40.

#### 2.1.14.5 Wiring a 0/4–20 mA Analog Outputs Option Card

The CTF878 flowmeter can accommodate up to 4 analog outputs option cards. Each analog outputs option card includes four isolated 0/4–20 mA outputs (designated as A, B, C and D).

Connections to these outputs may be made with standard twisted-pair wiring. The total current loop impedance for these circuits must not exceed 1,000 ohms. Wire this terminal block in accordance with the pin number assignments shown in Figure 25 on page 40.

Once the CTF878 system is completely wired, proceed to Chapter 3, *Initial Setup*, to configure the unit for operation.

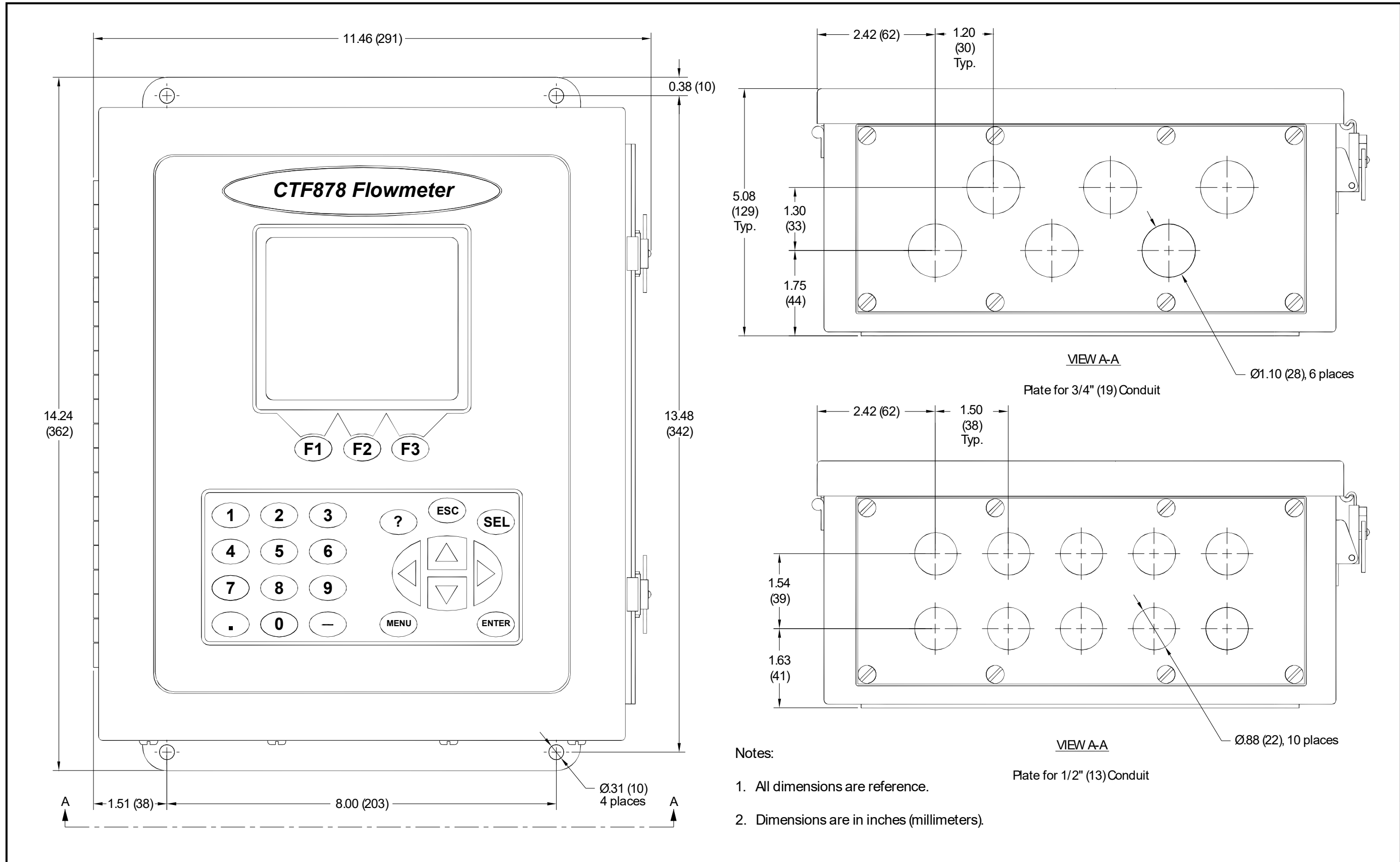
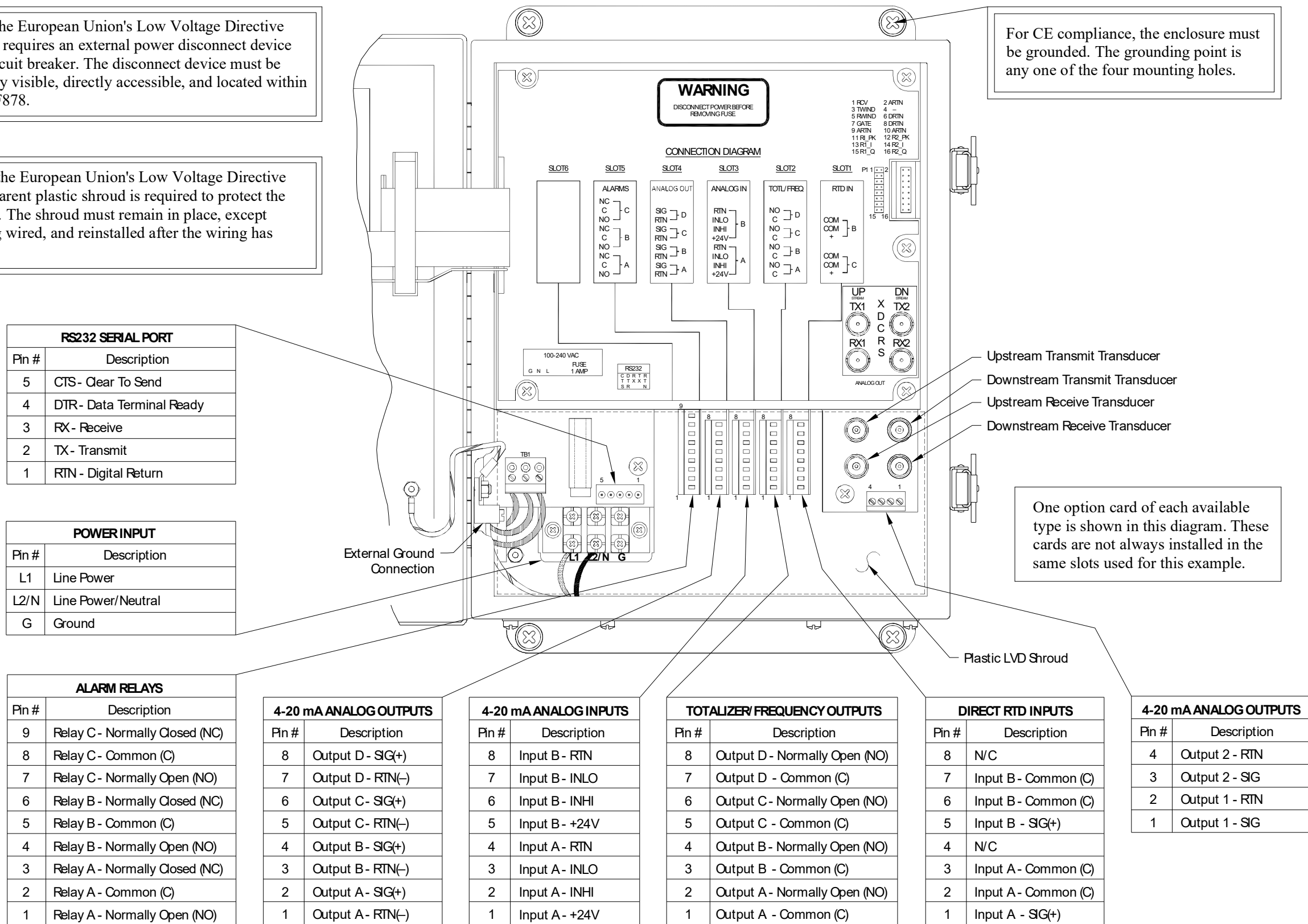

Figure 24: CTF878 Type 4X Enclosure - Outline and Mounting (ref. dwg #712-1186)

For compliance with the European Union's Low Voltage Directive (73/23/EEC), this unit requires an external power disconnect device such as a switch or circuit breaker. The disconnect device must be marked as such, clearly visible, directly accessible, and located within 1.8 m (6 ft) of the CTF878.

For compliance with the European Union's Low Voltage Directive (73/23/EEC), a transparent plastic shroud is required to protect the electrical connections. The shroud must remain in place, except while the unit is being wired, and reinstalled after the wiring has been completed.

For CE compliance, the enclosure must be grounded. The grounding point is any one of the four mounting holes.



RS232 SERIAL PORT	
Pin #	Description
5	CTS - Clear To Send
4	DTR - Data Terminal Ready
3	RX - Receive
2	TX - Transmit
1	RTN - Digital Return

POWER INPUT	
Pin #	Description
L1	Line Power
L2/N	Line Power/Neutral
G	Ground

ALARM RELAYS	
Pin #	Description
9	Relay C - Normally Closed (NC)
8	Relay C - Common (C)
7	Relay C - Normally Open (NO)
6	Relay B - Normally Closed (NC)
5	Relay B - Common (C)
4	Relay B - Normally Open (NO)
3	Relay A - Normally Closed (NC)
2	Relay A - Common (C)
1	Relay A - Normally Open (NO)

4-20 mA ANALOG OUTPUTS	
Pin #	Description
8	Output D - SIG(+)
7	Output D - RTN(-)
6	Output C - SIG(+)
5	Output C - RTN(-)
4	Output B - SIG(+)
3	Output B - RTN(-)
2	Output A - SIG(+)
1	Output A - RTN(-)

4-20 mA ANALOG INPUTS	
Pin #	Description
8	Input B - RTN
7	Input B - INLO
6	Input B - INHI
5	Input B - +24V
4	Input A - RTN
3	Input A - INLO
2	Input A - INHI
1	Input A - +24V

TOTALIZER/FREQUENCY OUTPUTS	
Pin #	Description
8	Output D - Normally Open (NO)
7	Output D - Common (C)
6	Output C - Normally Open (NO)
5	Output C - Common (C)
4	Output B - Normally Open (NO)
3	Output B - Common (C)
2	Output A - Normally Open (NO)
1	Output A - Common (C)

DIRECT RTD INPUTS	
Pin #	Description
8	N/C
7	Input B - Common (C)
6	Input B - Common (C)
5	Input B - SIG(+)
4	N/C
3	Input A - Common (C)
2	Input A - Common (C)
1	Input A - SIG(+)

4-20 mA ANALOG OUTPUTS	
Pin #	Description
4	Output 2 - RTN
3	Output 2 - SIG
2	Output 1 - RTN
1	Output 1 - SIG

Figure 25: CTF878 Electronics Console Wiring (ref. dwg #702-508)



## Chapter 3.

### 3.1 Initial Setup

#### 3.1.1 Introduction

This chapter provides instructions for entering the programming data required to place the CTF878 flowmeter into operation. Before the CTF878 can begin taking measurements and displaying valid data, the current system and pipe parameters must be entered. Additional programming options provide access to the more advanced features of the CTF878, but this information is not required to begin taking measurements.

**Note:** See the Programming Manual for information on those User Program options not covered in this manual.

#### 3.1.2 Powering Up

Immediately upon power up the CTF878 emits a short beep and displays a "PCI Loader" message. It then validates the instrument programming, and displays the Panametrics Sensing logo and the software version. If the meter fails any of these tests, contact the factory.

After the meter conducts all the self checks, the screen then appears similar to the one shown in Figure 26 below.

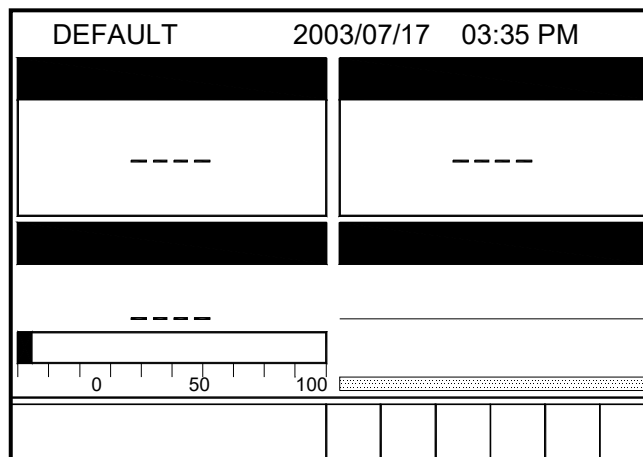
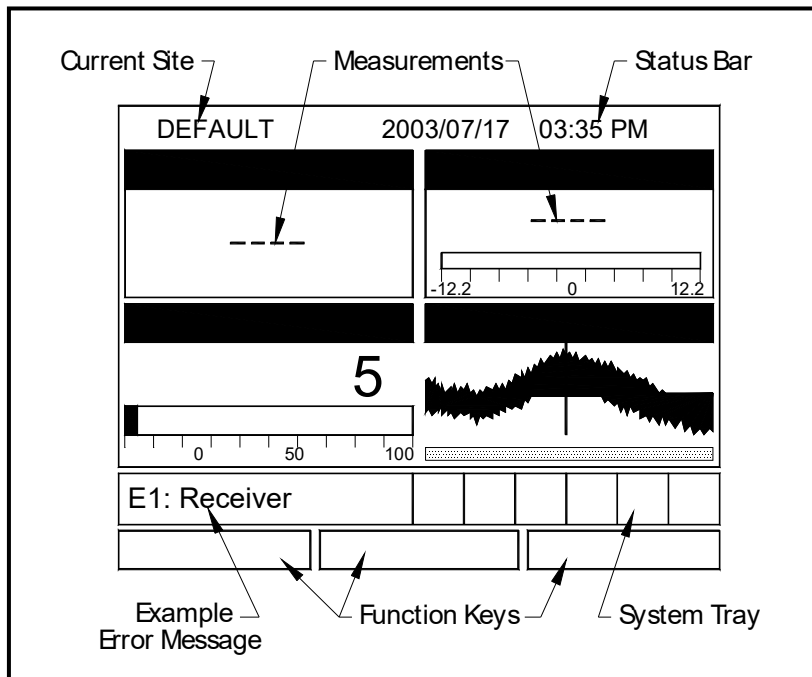

**Figure 26: Screen After Powering ON**

### 3.1.3 Using the Screen

The essential features for operating the CTF878 are the screen and keypad. Although these features are common, the CTF878 design offers particular features to simplify and speed operation. The new menu system is very user-friendly; program information is now located on tabbed forms instead of on a long, linear menu.

The primary function of the screen is to display information in order for you to accurately and easily take measurements. The CTF878 screen consists of those parts shown in Figure 27 below.





**Figure 27: CTF878 Screen in Operate Mode**

The top line of the screen is the status bar, which normally displays the time and date. However, when you press **[MENU]** (the menu key), the menu bar replaces the status line.

The middle of the screen is the work area, which displays the measured parameters, numeric measurements, and both bar and line graphs. When you enter a selection on the menu bar (see *Programming Site Data* on page 46), this area displays menu prompts. A line at the bottom of the area also displays error code messages, which are described in more detail in the *Service Manual*.

The system tray displays icons that indicate meter operations not otherwise shown. Table 3 below lists the icons and their meanings.

Icon	Function	Meaning
	Alert	The meter encountered an error in operation.
	Log	A log is running (marks).
	Log	A log is pending (no marks).

The bottom of the screen displays the three function key options: F1, F2 and F3. These keys have different functions, depending on the task being performed. The initial, factory setup, configuration for these keys is as follows:

- *F1 = Transducer*
- *F2 = Diagnostics*
- *F3 = Save Now*

### 3.1.4 Using the Keypad

The CTF878 keypad contains 24 keys, that are labeled with their functions. The complete keypad is illustrated in Figure 28 below and a detailed description of the functions for each of the 24 keys is listed in Table 3 on page 7.

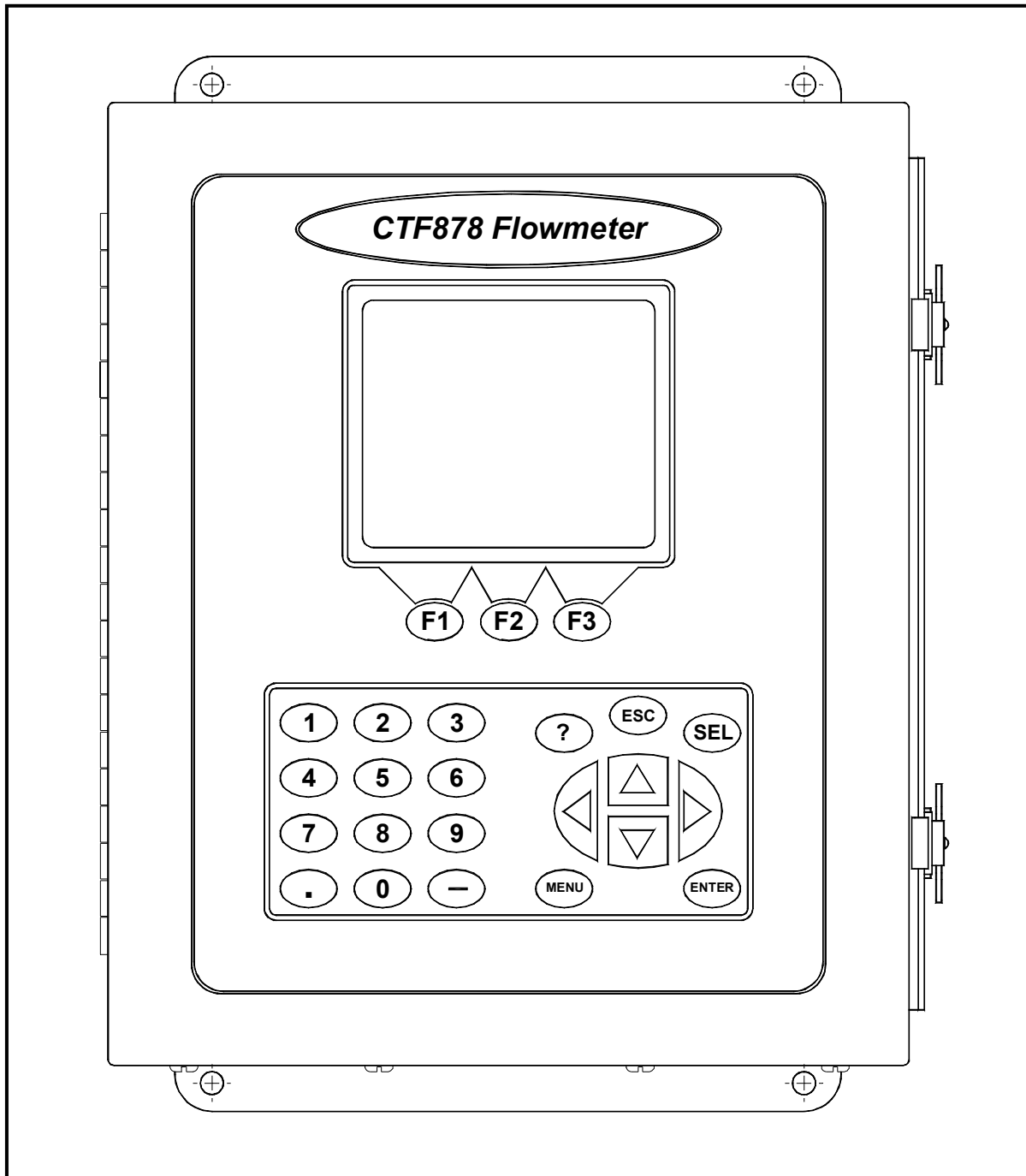
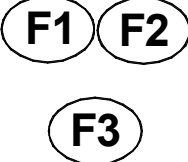
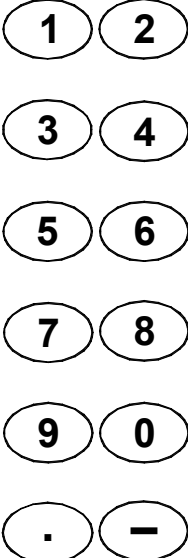
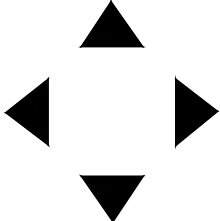







Figure 28: CTF878 Keypad

Key	Function
	<b>Software Function Keys:</b> Press to select the special functions displayed directly above them at the bottom of the screen.
	<b>12 Numeric Keys:</b> Use to enter numeric data.
	<b>Arrow Keys:</b> Press to scroll through function choices in measurement mode or to scroll through menu choices in programming mode. Press [←] as a backspace key in programming mode.
	<b>Help Key:</b> Use to access on-line help. See the next section for details.
	<b>Escape Key:</b> Press to exit menus or menu options at any time, or cancel a numeric entry.
	<b>Select Key:</b> Use to move between data measurements on the screen.
	<b>Menu Key:</b> Press to access the Main Menu.
	<b>Enter Key:</b> Use to enter a particular menu or to enter selected values into CTF878 memory.

### 3.1.5 Programming Site Data

#### 3.1.5.1 Entering the Program Menu

To enter the Program Menu, press the **[MENU]** key at the lower right of the CTF878 keypad. The Menu Bar replaces the Status Bar at the top of the screen. Press the **[▶]** arrow key once to scroll from the Site Menu to the Program Menu. At the Program Menu, press **[ENTER]**. The screen appears similar to Figure 29 below. While following the programming instructions, see the *Program Menu Map*, Figure 46 on page 65.

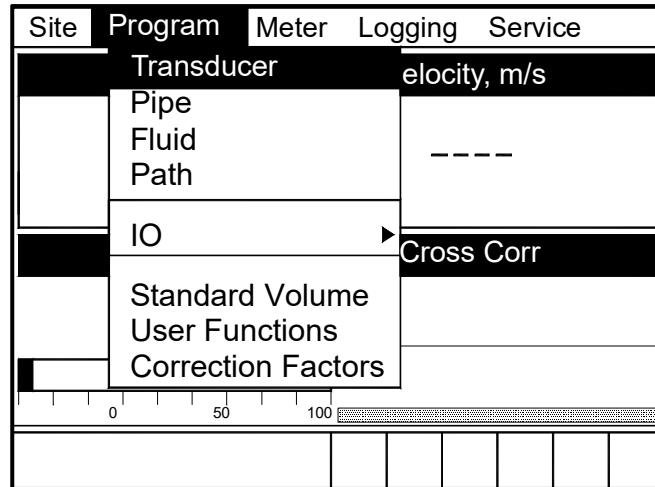

**Figure 29: Program Menu**

To scroll to a particular option, press the **[▼]** or **[▲]** arrow keys until you reach the option. Then press **[ENTER]** to open the option window.

When entering parameters in an option, press:

- The **[▼]** key to step through the available parameters
- The **[▲]** key to scroll back to a previously entered parameter
- The **[F2]** key (Cancel) or the **[ESC]** key to exit an option at any time and return to Operate Mode without changing the parameters.

**Note:** The Transducer, Pipe, Fluid and Path parameters are categorized under the same Transducer/Pipe menu, as shown in Figure 30 below. You can be more time-efficient by programming the parameters in all four entries under Transducer/Pipe before exiting the menu.

When you are highlighting a parameter in one of the four entries, and you wish to go to another entry:

1. Use the [▲] key to scroll up to the current tab (the entry that you are under).
2. Press the [◀] or [▶] key to select the parameter you want to access, then press [ENTER].

### 3.1.5.2 Entering Transducer Parameters

To enter the Transducer option, scroll to the Transducer tab on the Program Menu and press [ENTER]. The screen appears similar to Figure 30 below. To step through each parameter, press the [▼] key. Refer to the *Program Menu Map*, Figure 46 on page 65.

**Note:** If the CTF878 does not scroll to a particular parameter, the parameter is not necessary for that transducer type.

The screenshot shows a window titled "Transducer/Pipe" with four tabs: "Transducer", "Pipe", "Fluid", and "Path". The "Transducer" tab is selected. The window contains the following parameters and values:

Transducer	#310 (Shear)
Frq Up/Dn	0.500 0.471 MHz
Wedge Ang	35 °
Wedge Tmp	45 °C
Wedge SS	2480 m/s

At the bottom of the window are two buttons: "Cancel" and "OK".

**Figure 30: Transducer Option Window**

The next prompt asks you to enter the transducer number (printed on the transducer itself), or to specify that you are using a special application transducer.

1. From the Type prompt, press the [▼] key to reach the Transducer prompt, and press [ENTER].

2. A drop-down list of transducer numbers opens (see Figure 31 below). Press the [▼] or [▲] keys to scroll to the appropriate number, or scroll to “Special” for a special application transducer.
3. Press [ENTER] to confirm your selection.

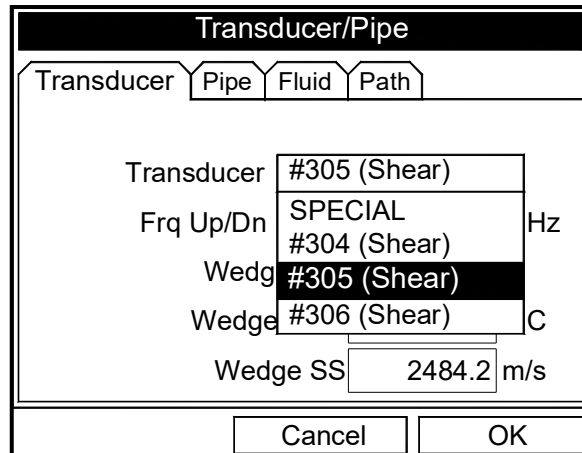

**Figure 31: Transducer Type Options**

Upon your selection, a warning screen appears similar to Figure 32 below. In three out of four warnings, the Receiver Board option number appears as part of the text.

**IMPORTANT:** If SPECIAL is selected as the transducer type, a number does not appear, however, the warning still states that the transducer selection must match the Receiver Board.

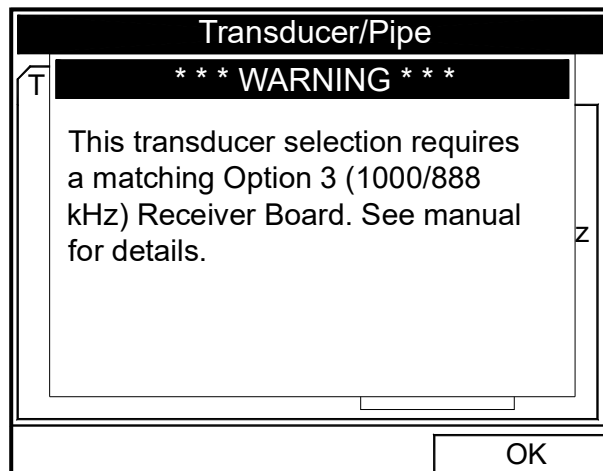

**Figure 32: Transducer Selection Warning Screen**

The Receiver Board option number corresponds to the frequency range selected with the original order (see Table 3-3 below).

Option No.	Frequency Range
3	1 MHz / 888 KHz
4	500 KHz / 471 KHz
5	250 KHz / 222 KHz

4. Compare the Receiver Board option number listed on the WARNING screen with the one assigned to your CTF878.



**Note:** The Receiver Board option number is the last digit of the CTF878's model number. That model number can be found on the label attached to the inside of the front cover. In Figure 33 below the Receiver Board option number is 3.

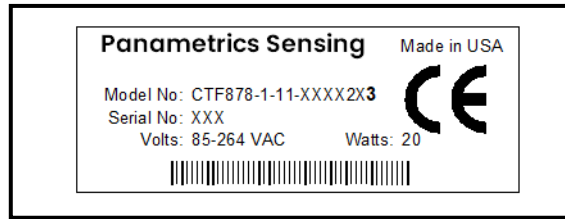

**Figure 33: Transducer Type Options**

The program now varies, depending on whether you have selected typical or SPECIAL transducers.

- If you have selected a typical transducer, the CTF878 comes programmed with the needed parameters. Proceed to *Parameters for Typical Transducers* on page 50.
- However, if your application requires entering a special transducer / receiver option, go to the next section, *Parameters for Special Transducers* on the same page.

### ***Parameters for Typical Transducers***

If a typical transducer has been selected, the user must:

1. Enter the transducer wedge temperature (Wedge Temp) text box and press [ENTER].
2. Type in the value (provided by the factory) and press [ENTER].
3. Proceed to *Entry Confirmation* on page 51.

### ***Parameters for Special Transducers***

**Note:** *Panametrics Sensing will supply the information required below with a special transducer / receiver option.*

The user must enter the appropriate transducer / receiver operating frequency range.

**IMPORTANT:** The CTF878 flowmeter and the transducers MUST have the same fixed frequency band of operation defined by the customer's application. The up and down frequencies selected in the Programming Menu MUST correspond to those of the installed Frequency Board. The frequency printed on the transducers represents a frequency band of operation and does not always match the up or down frequencies.

1. From the Transducer prompt, press the [▼] key to reach the Frequency Up (Frq Up) prompt, and press [ENTER].
2. A drop-down list of thirty-six frequencies opens, ranging from 0.222 to 8.00 MHz. Scroll to the correct frequency, and press [ENTER].
3. Repeat the same selection process for the Frequency Down (Frq Dn) prompt.

Next, you must enter the transducer wedge angle (Wedge Ang) and wedge soundspeed (Wedge SS).

4. Scroll to the appropriate text box and press [ENTER].
5. Type in the value (provided by the factory).

**Note:** *If you enter an incorrect numeric value, press the [◀] key to erase the last digit entered.*

6. Once the value has been entered, press [ENTER] and proceed to *Entry Confirmation* on page 51.

### Entry Confirmation

- To confirm the entries and return to Operate mode, press **[F3]** (OK).
- To leave the window without confirming the entries, press **[F2]** (Cancel) or the **[ESC]** key.

In either case, the CTF878 returns to Operate Mode.

### 3.1.5.3 Entering Pipe Parameters

To enter the Pipe option, scroll to the Pipe tab on the Program Menu and press **[ENTER]**. (From the Transducer window, you can scroll back up to the Transducer tab and press the **[▶]** arrow key to reach the Pipe window, and press **[ENTER]**.) The screen appears similar to Figure 34 below. To step through each parameter, press the **[▼]** key. See the Program Menu Map, Figure 46 on page 65.

**Note:** Refer to the installation reference Sound Speeds and Pipe Size Data (914-004) for additional information about pipe sizes and sound speeds.

Transducer/Pipe			
Transducer	Pipe	Fluid	Path
Material	Other		
Sound Speed	600	m/s	
OD, mm	ODxPI, mm	Wall, mm	
5	15.71	2	
Nominal	Schedule	<input type="checkbox"/> DIN	
		Cancel	OK

**Figure 34: Pipe Option Window**

1. The first prompt asks you to select the pipe material.
  - a. Press **[ENTER]** to enter the material prompt.
  - b. A drop-down list of materials opens as shown in Figure 35 below. Press the **[▼]** or **[▲]** keys to scroll to the appropriate material, or scroll to “Other” for a material not on the list. Press the **[▶]** key to scroll down by a page, or the **[◀]** key to scroll up by a page.
  - c. Press **[ENTER]** to confirm the choice.

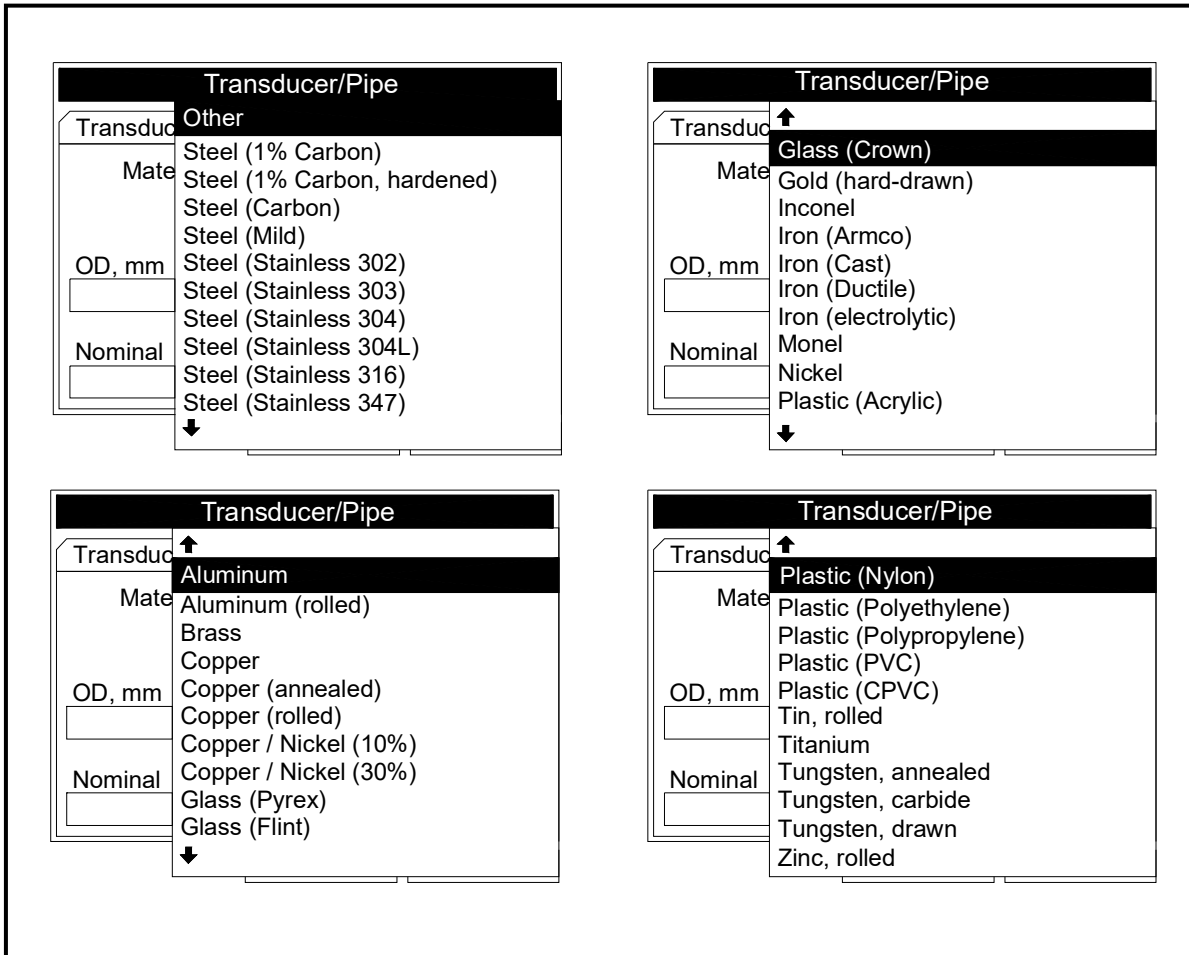

**Figure 35: Pipe Material Options**

The image shows a dialog box titled "Transducer/Pipe" with four tabs: "Transducer", "Pipe", "Fluid", and "Path". The "Pipe" tab is active. The dialog contains the following fields and controls:

- Material: Text box containing "Other"
- Sound Speed: Text box containing "600" followed by "m/s"
- OD, mm: Text box containing "5"
- ODxPI, mm: Text box containing "15.71"
- Wall, mm: Text box containing "2"
- Nominal: Text box (empty)
- Schedule: Text box (empty)
- DIN
- Buttons: "English", "Cancel", and "OK"

**Figure 36: Pipe Option Window**

2. For pipe diameter, two alternatives are available. The meter asks for the pipe outside diameter (OD) and wall thickness (Wall). But if you have selected certain pipe materials (carbon or stainless steel, cast iron, PVC and CPVC), you have the option of entering the pipe dimensions by a standardized schedule. Once you enter the nominal pipe size (Nominal) and identification (Schedule), the CTF878 determines the OD and wall thickness from an internal table.

If you want to use the diameter alternative (available for all materials):

- a. You must select from two choices, outside diameter or circumference.
  - The prompt moves to the outside diameter (OD) text box. Type the OD (in mm or in., whichever is displayed) into the box, and press **[ENTER]** to confirm your choice,

or

- Move the prompt to the circumference (ODxPI) text box. Type the circumference (in mm or in., whichever is displayed) into the text box, and press **[ENTER]** to confirm the choice.
- b. In either case, the next prompt asks for the wall thickness. Type the value (in mm or in., whichever is displayed) into the box, and press **[ENTER]** to confirm your choice.

**Note:** The measurement units shown depend on the choices made in the English/Metric window or the Meter Settings menu. You can, however, change the measurement units in any text box by moving to that box and pressing the FI key.

If you select a material that has the Schedule option, and you wish to use that alternative:

- a. The prompt asks if you wish to apply ANSI (the ANSI schedule). Press **[ENTER]** to select (or deselect) the ANSI box.

**Note:** *Selecting the ANSI box enables you to use the Schedule alternative*

- b. Press the [**◀**] key twice to move the prompt to the Nominal pipe size drop-down menu. Press **[ENTER]** to open the menu. Scroll to the desired pipe size, and press **[ENTER]** to confirm your choice.
  - c. Press the [**▶**] key to move the prompt to the Schedule drop-down menu. Press **[ENTER]** to open the menu. Scroll to the desired schedule, and press **[ENTER]** to confirm the choice.
- To confirm the entries and return to Operate Mode, press **[F3]** (OK).
  - To leave the window without confirming the entries, press **[F2]** (Cancel) or the **[ESC]** key.

In either case, the CTF878 returns to Operate Mode.

### 3.1.5.4 Entering Fluid Types and Speeds

To access the Fluid option, scroll to the Fluid tab on the Program Menu and press **[ENTER]**. (If you are already in the Transducer/Pipe form, press the **[▶]** arrow key to reach the Fluid window, and press **[ENTER]**.) The screen appears similar to Figure 37 below. To step through each parameter, press the **[▼]** key. Refer to the Program Menu Map, Figure 46 on page 65.

The figure consists of two screenshots of the 'Transducer/Pipe' window, specifically the 'Fluid' tab. The top screenshot shows the 'Fluid' field set to 'Other', 'Sound Speed' at 600 m/s, and 'K/V x 10<sup>-6</sup>' at 14.607 m<sup>2</sup>/s. The bottom screenshot shows the 'Fluid' dropdown menu open, with 'Other' selected, and 'Air' and 'Natural Gas' as other options. Both screenshots have 'Cancel' and 'OK' buttons at the bottom.

**Figure 37: Fluid Type Options**

To select the fluid:

1. Press **[ENTER]** to open the drop-down menu.
2. Use the **[▼]** key to scroll through the options.
3. Press **[ENTER]** to confirm your selection.

**Note:** If you select Air or Natural Gas, the meter sets the soundspeed and suggests a value for  $K/V \times 10^{-6}$ . If you wish, you can change the value of  $K/V \times 10^{-6}$ .

If you select Other, you must enter values for Sound Speed and for  $K/V \times 10^{-6}$  (see Installation Reference #914-004, Sound Speeds and Pipe Size Data).

- To confirm the entries and return to Operate Mode, press **[F3]** (OK). The CTF878 returns to Operate Mode.
- To leave the window without confirming the entries, press **[F2]** (Cancel) or the **[ESC]** key. The CTF878 returns to Operate Mode.

### 3.1.5.5 Entering Path Parameters

To enter the Path option, scroll to the Path entry on the Program Menu and press **[ENTER]**. (From the Fluid window, you can scroll back up to the Fluid tab and and press **[ENTER]**.) The screen appears similar to Figure 38 below. To step through each parameter, press the **[▼]** key. Refer to *Program Menu Map*, Figure 46 on page 65.

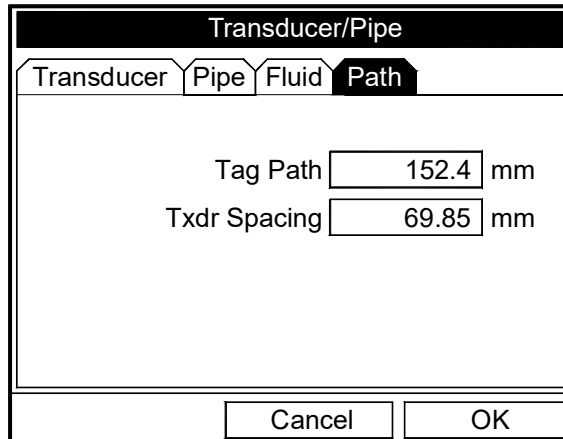

The screenshot shows a window titled "Transducer/Pipe" with four tabs: "Transducer", "Pipe", "Fluid", and "Path". The "Path" tab is selected. Inside the window, there are two input fields: "Tag Path" with the value "152.4" and "mm" to its right, and "Txdr Spacing" with the value "69.85" and "mm" to its right. At the bottom of the window, there are two buttons: "Cancel" and "OK".

**Figure 38: Path Window**

#### ***Path Parameters for Clamp-On Transducers***

The CTF878 path menu includes two parameters:

- *TAG Path*
- *Transducer Spacing*

The *TAG Path* is calculated from the data entered in the Pipe parameters under Program. It can be overwritten if the user wants to use a value other than the one calculated by the flowmeter. However, it must always match the *TAG Path* set on the clamping fixture for reliable operation. If the path is changed on the instrument and on the clamping fixture, it must be within  $\pm 10\%$  of the original *TAG Path* calculated by the flowmeter.

The *Transducer Spacing* is calculated from the data entered in the Transducer/Pipe/Fluid parameters. The value of *Transducer Spacing* is NOT used in the flowmeter's data processing, unlike the *Tag Path*. It is pointless to change the *Transducer Spacing* in the instrument. It is only an output intended to tell the user the distance to be set between a Transmitter and a Receiver for optimal signal transmission.



### 3.1.5.6 Entering Analog Outputs

The Analog Output option enables you to enter information to set up output parameters. To enter the option, scroll to the Main Board entry on the Program Menu and press **[ENTER]** (see Figure 39 below). Then select from the AnalogOut options and press **[ENTER]**.

**Note:** Input/Output Menu options may appear in a different order, depending on where each option card is installed. Cards are numbered from right to left.

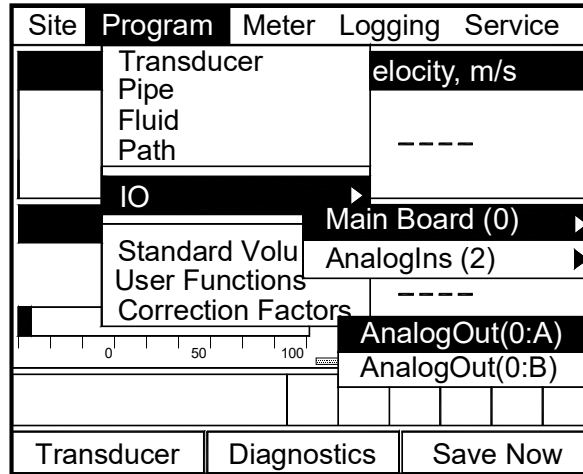

**Figure 39: Selecting Analog Output**

The screen appears similar to Figure 40 below. To step through each parameter, press the **[▼]** key. See the *Program Menu Map*, Figure 47 on page 66.

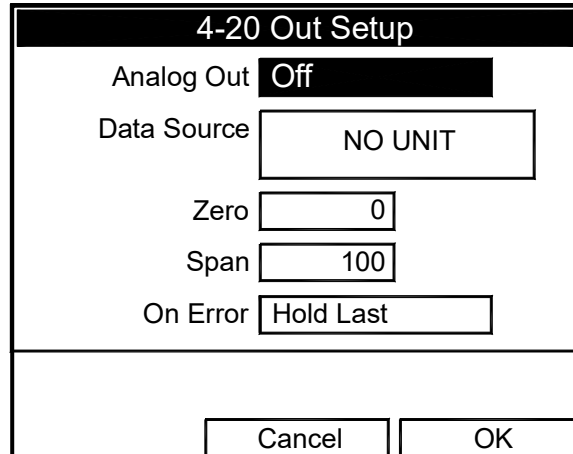

**Figure 40: Analog Output Window**

1. The first prompt enables you to select a range to send a current signal to a recording device (see Figure 41 below).
  - a. Press **[ENTER]** to open the drop-down menu.
  - b. Scroll to the desired output from three choices: Off, 0–20 mA, and 4–20 mA.
  - c. Press **[ENTER]** to confirm your selection.

**Note:** If you select “Off,” you will not be able to access any other parameters in this option.

**Figure 41: Analog Out Selection Window**

2. The next prompt asks you to select the analog output type from a list of choices, as shown in Figure 42 below.

**Figure 42: Data Source Selection Window**

- a. Press **[ENTER]** to open the window.
  - b. Scroll to the desired output type.
  - c. Press **[SEL]** to confirm your selection.
  - d. The prompt then moves to a list of unit types. (The available units depend on the selection made at the Data Source prompt.) Scroll to the desired output unit.
  - e. Press **[F3]** (OK) to confirm your selection.
3. The next prompt requests the zero (base) value for the analog output. This value represents the 0/4 mA output (in flow units).

- a. Press **[ENTER]** to open the text box.
  - b. Use the numeric keys to enter the desired value.
  - c. Press **[ENTER]** to confirm your selection.
4. The next prompt requests the span (full scale) value for the analog output. This value represents the 20 mA output (in flow units).
  - a. Press **[ENTER]** to open the text box.
  - b. Use the numeric keys to enter the desired value.
  - c. Press **[ENTER]** to confirm your selection.
5. The last prompt, On Error, asks you to select how the CTF878 will handle the analog outputs in the event of a fault condition. The meter offers three alternatives:
  - *Hold Last Value (hold the last good reading)*
  - *Force Low (force the reading to 0 or 4 mA)*
  - *Force High (force the reading to 20 mA).*
  - a. Press **[ENTER]** to open the drop-down menu.
  - b. Scroll to the desired selection.
  - c. Press **[ENTER]** to confirm your selection.

You have completed entering data in the Analog Output option.

- To confirm the entries and return to Operate mode, press **[F3]** (OK). The CTF878 returns to Operate Mode.
- To leave the window without confirming the entries, press **[F2]** (Cancel) or the **[ESC]** key. The CTF878 returns to Operate Mode.

### 3.1.5.7 Entering Digital Outputs

While resembling the Analog Output option, the Digital Output option enables you to set up parameters necessary for a digital output. To enter the option, scroll to the Digital Output entry on the Program / IO / Freq/Tot Menu and press **[ENTER]**.

**Note:** *Input/Output Menu options may appear in a different order, depending on where each option card is installed. Cards are numbered from right to left.*

The screen appears similar to Figure 43 below. To step through each parameter, press the **[▼]** key. Refer to the Program Menu Map, Figure 48 on page 67.

Digital Output	
Function	Pulse Totalizer
Data Source	Fwd Totalizer Fwd m <sup>3</sup>
Units/Pulse	1 m <sup>3</sup>
Pulse Width	10 μs
<input type="button" value="Cancel"/> <input type="button" value="OK"/>	

**Figure 43: Digital Output Window**

- I.** The first prompt enables you to select the output function from three choices: Off, Pulse Totalizer, Frequency
  - a.** Press **[ENTER]** to open the drop-down menu.
  - b.** Scroll to the desired function.
  - c.** Press **[ENTER]** to confirm your selection.

**Note:** *If you select Off, you will not be able to access any other parameters in this option.*

2. The next prompt asks you to select the data source for the digital output. The choices vary with the function. For Pulse Totalizer (see Figure 43 on page 60), the available choices include:
  - *Forward Totalizer*
  - *Reverse Totalizer*
  - *Standard Forward Totalizer*
  - *Standard Reverse Totalizer*
  - a. Press **[ENTER]** to open the data source selection window.
  - b. Scroll to the desired source.
  - c. Press **[SEL]** to confirm your selection.
  - d. The prompt then moves to a list of unit types. (The available units depend on the selection made at the Data Source prompt.) Scroll to the desired output unit.
  - e. Press **[F3]** (OK) to confirm your selection.
3. The last set of parameters that appears depends on the selection you made at the Function prompt.

If you selected Pulse Totalizer:

The prompt asks for the units/pulse and the pulse width (in microseconds). (Figure 43 on page 60 illustrates a Digital Output window configured for the Pulse Totalizer function.) For the Units/Pulse and Pulse Width parameters:

- a. Press **[ENTER]** to open the text box.
- b. Use the numeric keys to enter the desired value.
- c. Press **[ENTER]** to confirm your selection.

If you selected Frequency:

The prompt asks for the minimum and maximum value for the category and units selected and the minimum and maximum frequency. For each parameter:

- a. Press **[ENTER]** to open the text box.
- b. Use the numeric keys to enter the desired value.
- c. Press **[ENTER]** to confirm your selection.

### 3.1.5.8 Entering a Calibration Factor

The final option in the Program Menu, Correction Factors, allows you to enter and modify the Calibration Factor. To enter the Correction Factor option, scroll to the Correction Factors selection on the Program Menu and press **[ENTER]**. The screen appears similar to Figure 44 below. To access the Calibration Factor, press the **[▼]** key. Refer to the *Program Menu Map*, Figure 46 on page 65.

The screenshot shows a window titled "Correction Factors" with a sub-header "Calibration Factor". The window contains the following elements:

- "Calibration Factor" with two radio buttons: "On" (unselected) and "Off" (selected).
- "K Factor" with two radio buttons: "Single" (selected) and "Table" (unselected).
- "Meter K-Factor" with a text input field containing the value "1".
- "Data Source" with a dropdown menu showing "NO UNIT".
- An "Edit Table" button below the "Data Source" dropdown.
- At the bottom of the window, there are two buttons: "Cancel" and "OK".

**Figure 44: Calibration Factor Window**

1. To enable or disable the Calibration Factor, scroll down to the next line and select On or Off.
  - a. Use the **[◀]** and **[▶]** keys to scroll to the appropriate option.
  - b. Press **[ENTER]** to confirm your selection.
2. If On is selected for the Calibration Factor, scroll down to choose a Single K-Factor or a Table of K-Factors.
  - a. Use the **[◀]** and **[▶]** keys to scroll to the appropriate radio button.
  - b. Press **[ENTER]** to confirm your selection.

If you selected Single:

1. Scroll down to the Meter K-Factor box. This feature enables a single multiplier to be applied to the flow rate reported by the CTF878.

**Note:** *The default Meter K-Factor value is 1.*

2. Press **[ENTER]** to open the text box.
3. Use the numeric keys to enter the desired value. The typical factor is between 0.5 and 2.00.
4. Press **[ENTER]** to confirm your selection.

You have completed entering data for a single Calibration Factor.

- To confirm the entries and return to Operate mode, press **[F3]** (OK). The CTF878 returns to Operate Mode.
- To leave the window without confirming the entries, press **[F2]** (Cancel) or the **[ESC]** key. The CTF878 returns to Operate Mode.

If you selected Table:

The menu asks, first for the data source, and then for the entry of values into the Correction Factor table. This feature allows the user to “curve fit” velocity calibration multiple data points (from several different data sources or flow variables) to the flow rate reported by the CTF878.

**Note:** *You must select the desired measurement and unit before you can enter the data table in Edit Table.*

1. Scroll down to the Data Source box.
2. Press **[ENTER]** to open the Data Source window. The Select Measurement window (Figure 42 on page 58) appears.
3. Enter the desired measurement and units as described on page 58.
4. Press **[F3]** (OK) to confirm your selection.
5. Scroll down to Edit Table.

6. Press **[ENTER]** to open the table, which appears similar to Figure 45 below.

Edit KFactor Table		
		0
	Data Source	KFactor
1		
2		
3		
4		
5		
		Cancel
		OK

**Figure 45: KFactor Table**

7. Use the four arrow keys to move to the desired entry in the table.
8. Use the numeric keys to enter the desired value for the data source, and press **[ENTER]** to confirm the entry.
9. Press the **[▶]** key to move to the KFactor column. Use the numeric keys to enter the desired value, and press **[ENTER]** to confirm the entry.
10. Repeat steps 7, 8 and 9 for the remainder of the table.
11. When you have completed entering values, press **[F3]** (OK) to confirm the table and return to the Correction Factors window.

You have completed entering data for correction factors.

- To confirm the entries and return to Operate mode, press **[F3]** (OK). The CTF878 returns to Operate Mode.
- To leave the window without confirming the entries, press **[F2]** (Cancel) or the **[ESC]** key. The CTF878 returns to Operate Mode.

To aid in following the programming instructions, a complete menu map of the *User Program* is included in Figure 46 on page 65, Figure 47 on page 66 and Figure 48 on page 67.



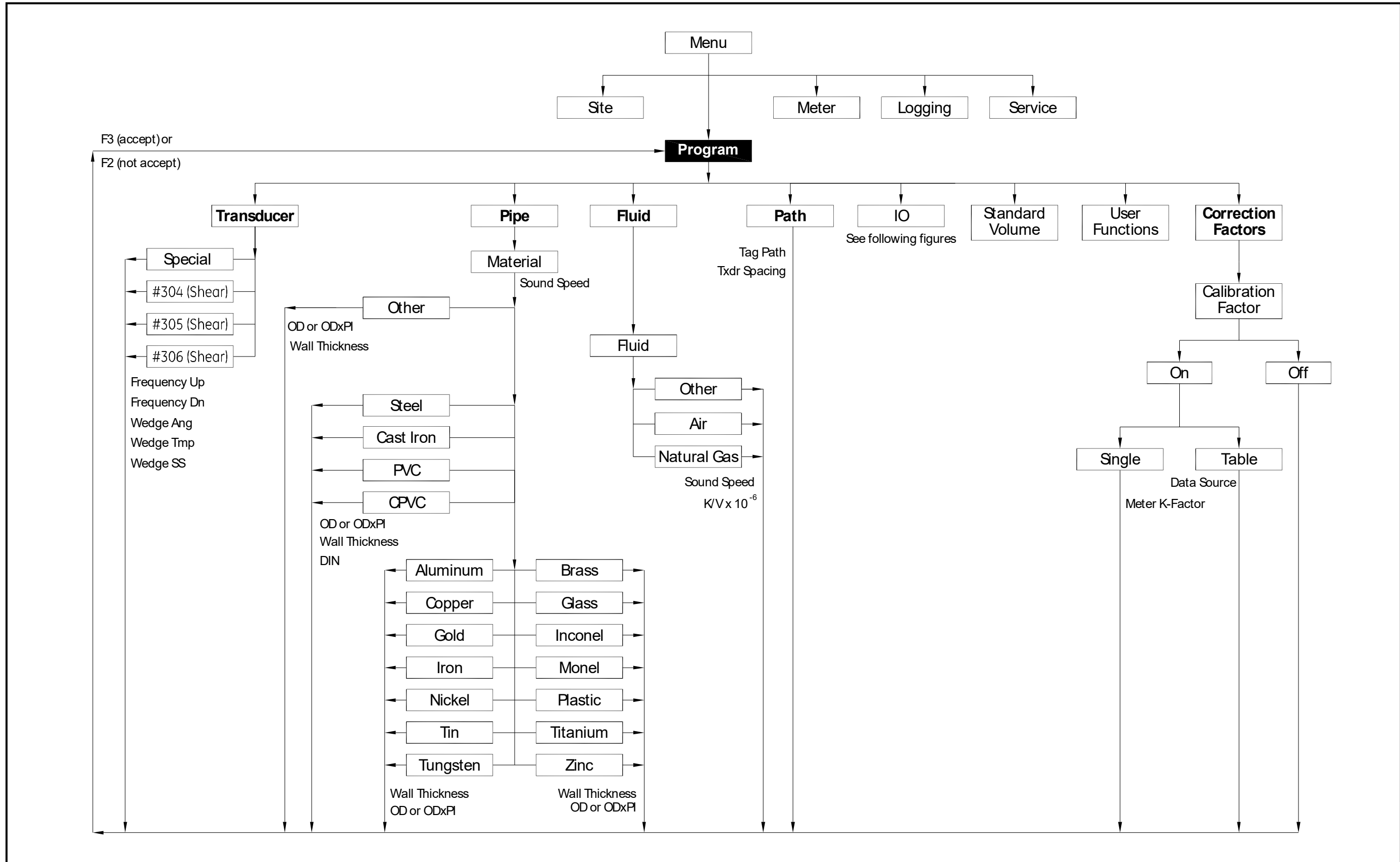

Figure 46: Program Menu Map - Initial Setup

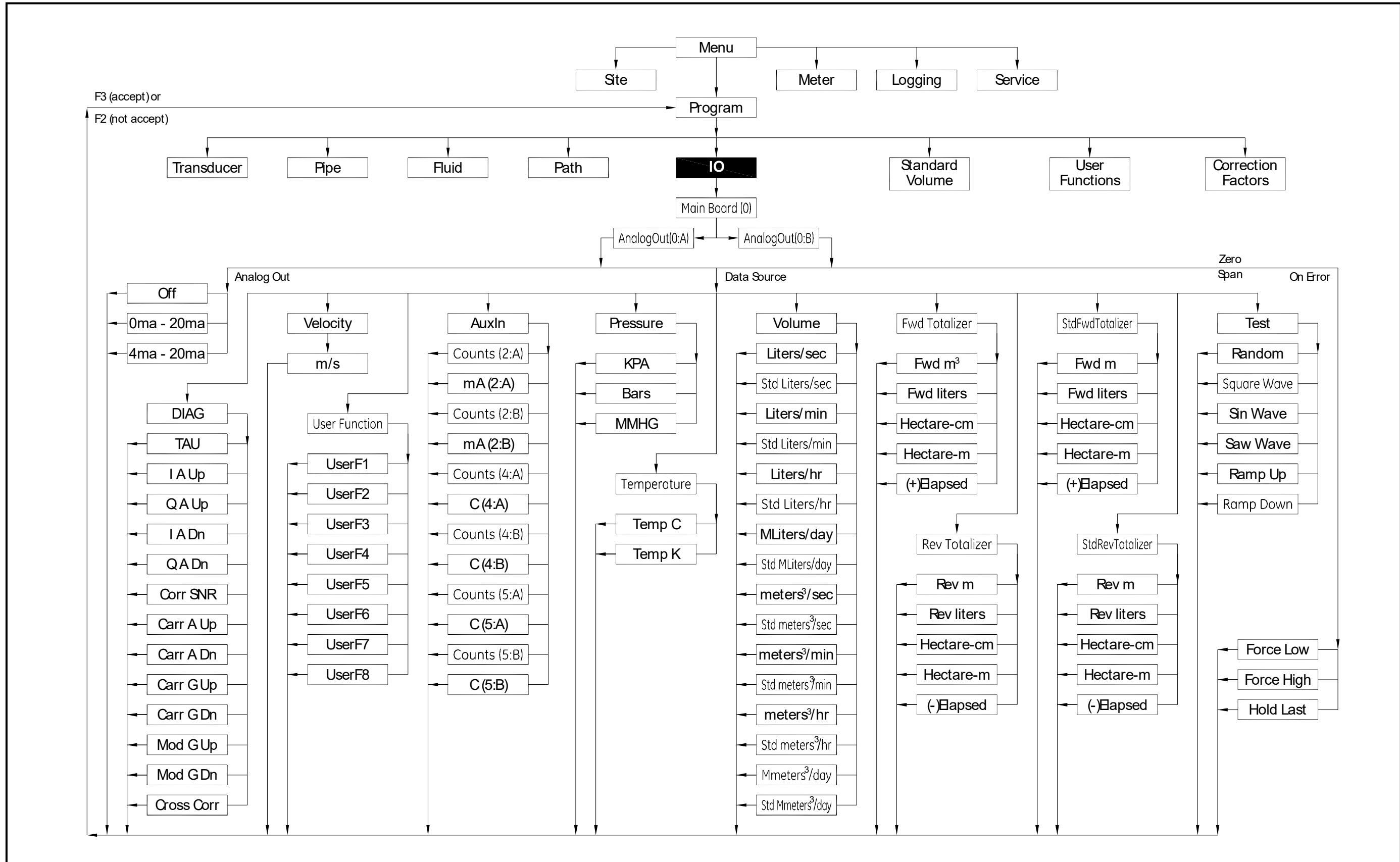

Figure 47: Input/Output Menu Map - Initial Setup for Analog Outputs

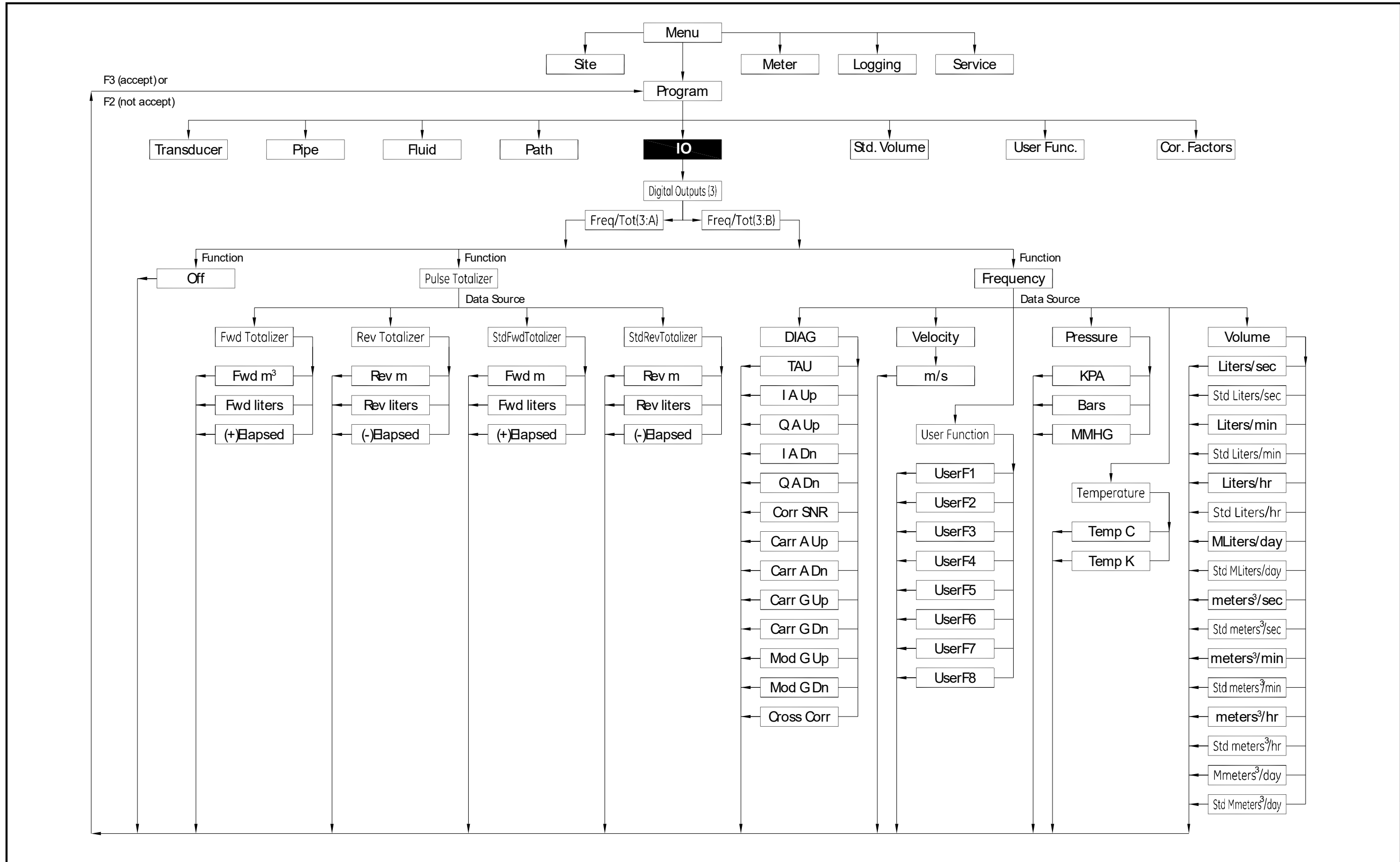

Figure 48: Input/Output Menu Map - Initial Setup for Digital Outputs



## Chapter 4.

### 4.1 Operation

#### 4.1.1 Introduction

See Chapter 2, *Installation*, and Chapter 3, *Initial Setup*, to prepare the system for operation. When the meter is ready to take measurements, proceed with *Displaying and Configuring Data*, below.

**Note:** To store site data in files for current and future access, refer to *Creating and Managing Sites, Chapter 2 in the CTF878 Programming Manual*.

#### 4.1.2 Displaying and Configuring Data

The CTF878 enables the viewing of from one to four different measurement parameters simultaneously. The screen can show these parameters not only in numeric format, but as line or bar graphs as well.

You can configure any given measurement for your particular requirements. To configure an individual measurement, press **[SEL]** from the Operate Mode window. A cursor appears next to the parameter closest to the upper left corner. Continuing to press **[SEL]** enables the cursor to scroll through the other displayed measurements. Once you have reached a particular window, pressing the **[ENTER]** button opens the menu for that window, as shown in Figure 49 below. To learn how to use the display window menu, go to *Format Option* on page 70, *View Option* on page 70, and/or *Limits Option* on page 71.

]

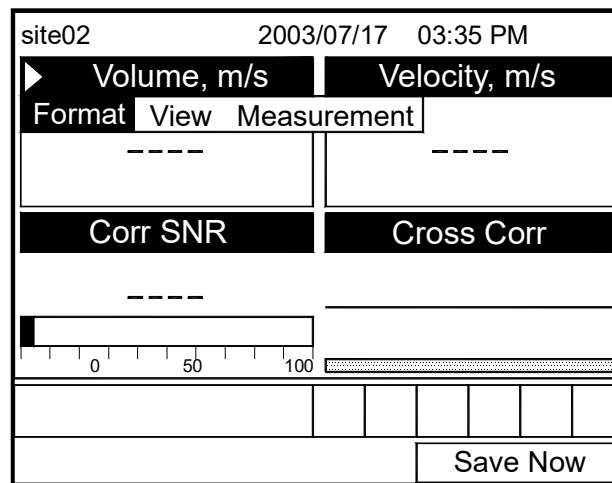
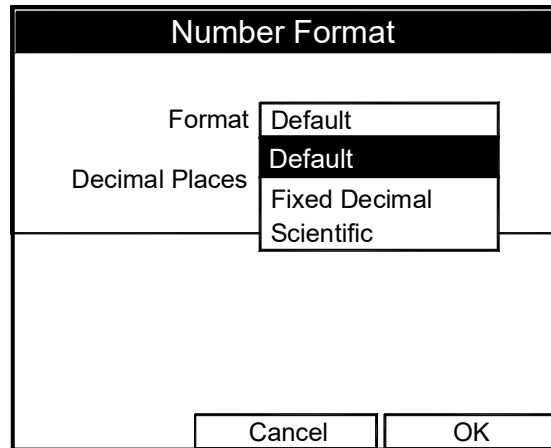

**Figure 49: Display Screen After Pressing [SEL]**

### 4.1.2.1 Format Option

Format, the first option on the menu, allows you to specify the type of notation and the number of decimal places for the measurement in that window. Press **[ENTER]** and the submenu shows two options: Format and Decimal Places. Press the **[▼]** or **[▲]** arrow keys to select either entry, and press **[ENTER]**. The screen appears similar to Figure 50 below. To scroll to a particular parameter or menu entry, press the **[▼]** or **[▲]** key.

**Note:** If the window displays a line or bar graph, the Measurement option appears instead of Format in the menu.



**Figure 50: Number Format Window**

1. The first entry, Format, asks you to select the numeric format from three choices: default, fixed decimal and scientific. Default provides the default resolution, while Fixed Decimal allows users to override the standard resolution. Scientific format displays the value in mantissa and exponent format.
  - a. Press **[ENTER]** to open the drop-down list of format choices.
  - b. Scroll to the appropriate selection.
  - c. Press **[ENTER]** to confirm your choice.
2. The second step asks you to choose the number of decimal places to be displayed. Available choices range from 0 to 4 places.
  - a. Press **[ENTER]** to open the drop-down list.
  - b. Scroll to the appropriate number.
  - c. Press **[ENTER]** to confirm your choice.
3. To confirm the entries and return to Operate mode, press **[F3]** (OK). To leave the window without confirming the entries, press **[F2]** (Cancel) or the **[ESC]** key.

### 4.1.2.2 View Option

The second option, View, allows you to select the presentation of a parameter in one of three formats: numeric, bar graph or line graph.

1. From the Display Menu, press the **[▶]** key once to reach the View option, and then press **[ENTER]**.
2. A drop-down menu shows the three formats. Scroll to the appropriate selection.
3. Press **[ENTER]** to confirm your selection.

The screen immediately displays any changes. For example, if you have changed the first parameter to a line graph, the screen appears similar to Figure 51 below.

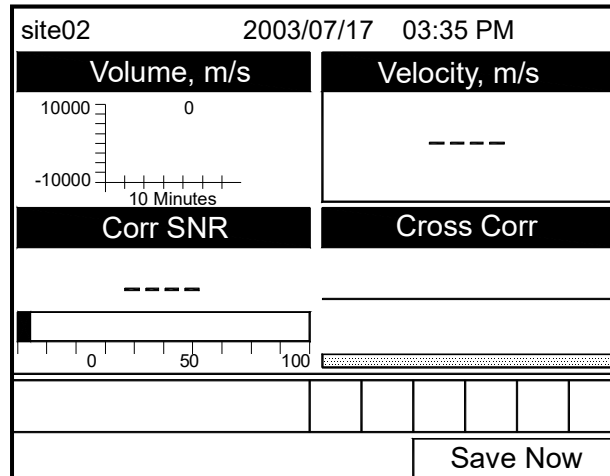

**Figure 51: Screen After Format Change**

#### 4.1.2.3 Limits Option

Once you have configured a parameter as a line or bar graph, you might need to change its presentation or values. The Limits option (replacing the Format option for line and bar graphs) enables you to program the minimum or maximum values displayed, the time interval and the display of the average value.

To enter the Limits option:

1. Press **[SEL]** from the Operate Mode window until you have reached the desired measurement.
2. Press **[ENTER]** to open the Display Menu.
3. Be sure the Limits option is highlighted, and press **[ENTER]**.
4. A drop-down menu entry, Change, appears. Press **[ENTER]** again.

The screen appears similar to Figure 52 below.

**Figure 52: Line (or Bar) Graph Parameters Window**

5. The first prompt asks for the minimum value shown in the graph.
  - a. Press **[ENTER]** to open the text box.
  - b. Use the numeric keys to enter the desired value.
  - c. Press **[ENTER]** to confirm the value.
6. Repeat the procedure in step 5 to enter the maximum value.  
A line graph involves two more prompts.
7. The next prompt asks for the display interval.
  - a. Press **[ENTER]** to open the text box. Use the numeric keys to enter the desired number. Press **[ENTER]** to confirm the value.
  - b. The second box asks for the interval in terms of seconds, minutes, hours, or days. Press **[ENTER]** to open the drop-down menu, and then press the **[▼]** or **[▲]** keys to move to the desired parameter. Press **[ENTER]** to confirm the entry.
8. The final three prompts ask for details of the graph configuration: if you want to use lines, plot the average value, or show the minimum and maximum values. Press the **[▼]** key to step through each value, and press **[ENTER]** to add a given detail as part of the graph.
9. When you have configured the graph, press **[F3]** (OK) to confirm the graph settings, or press **[F2]** (Cancel) to cancel the changes.

The screen returns to Operate Mode, and displays any changes.



#### 4.1.2.4 Measurement Option

On occasion, you might need to change the actual parameter measured in a given window. The Measurement option enables you to reconfigure the window with one of several categories of data and appropriate English or metric measurement units.

To enter the Measurement option:

1. Press **[SEL]** from the Operate Mode window until you have reached the measurement you want to replace.
2. Press **[ENTER]** to open the Display Menu.
3. Be sure the Measurement option is highlighted, and press **[ENTER]**.

The screen appears similar to Figure 53 below. The left column displays categories of data, while the right column displays English and metric measurement units (or, with the Diagnostics source shown, a list of diagnostics parameters).

4. Use the **[▼]** and **[▲]** arrow keys to reach the desired category of data, and press **[SEL]**.
5. Then use the **[▼]** or **[▲]** arrow keys to select the desired measurement unit (or diagnostic parameter). Press **[F3]** (OK) to confirm the entry, or **[F2]** (Cancel) to cancel the changes.
6. The screen returns to Operate Mode, and displays any changes.

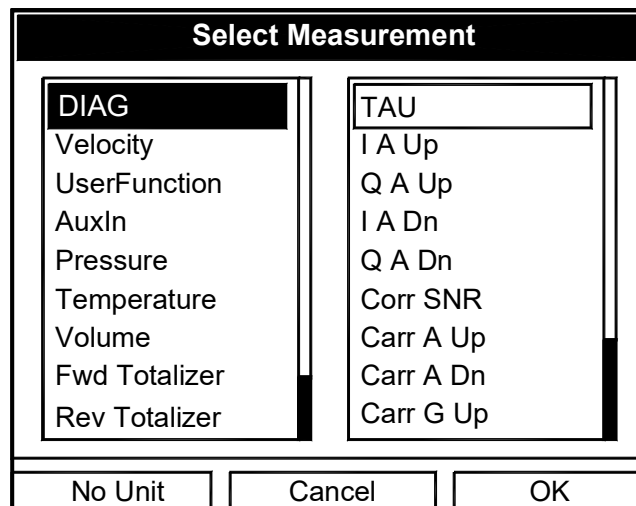
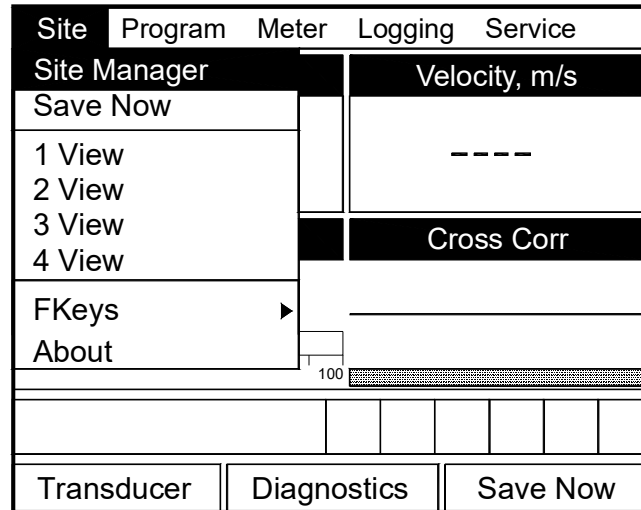

**Figure 53: Measurement Menu Window**

### 4.1.2.5 Customizing the Display Screen

You might wish to display one or two parameters, or customize the soft keys to quickly access particular menus. The Site Menu enables you to make more comprehensive changes in your display screen.

To enter the Site Menu, press the **[MENU]** key at the lower right of the CTF878 keypad. The Menu Bar replaces the Status Bar at the top of the screen. Scroll to Site using the **[◀]** and **[▶]** keys. Press **[ENTER]** or the **[▼]** arrow key. The screen now appears similar to Figure 54 below. While following the programming instructions, refer to Figure 60 on page 80.



**Figure 54: Site Menu**

- To specify the number of parameters displayed, go to page 75.
- To customize or clear softkeys (FKeys), go to page 76.

### Specifying the Number of Displayed Parameters

As mentioned earlier, the CTF878 can display one to four different measurement parameters simultaneously. However, sometimes you might wish to display only one or two parameters. To change the number of open display windows from within the Site Menu (see Figure 54 on page 74), use the [▼] or [▲] arrow keys to move to the desired number of views (1 View, 2 Views, etc.) Press [ENTER].

The screen displays the designated number of windows. For example, Figure 55 below shows the screen displayed in Figure 51 on page 71, reconfigured for a single view.

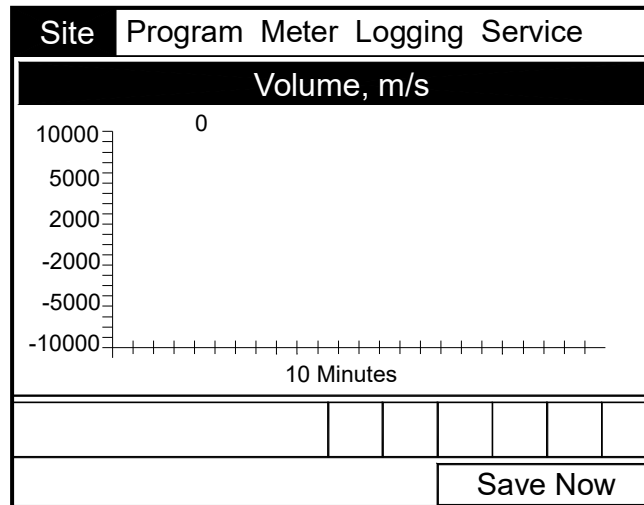

**Figure 55: Display Screen Configured for Single View**

**Note:** The CTF878 opens display windows from left to right and from top to bottom, starting from the upper left; that is, if you press "1 View," the parameter displayed in the upper left window appears. If you press "2 Views," the parameters shown in the two top windows appear. The view for "3 Views" adds the window in the lower left, and that for "4 Views" adds the window in the lower right.

### Customizing Softkeys

When the screen is in Operate Mode, you might wish to access a particular submenu frequently without the trouble of scrolling through menus. Customizing the softkeys (**[F1]**, **[F2]** and **[F3]**) allows you to access up to three submenus by pressing the associated softkey. You can customize a softkey from the Site Menu or from within a particular menu.

- To customize a softkey from within the Site Menu:
- From the Site Menu (shown in Figure 54 on page 74), use the [**▼**] or [**▲**] arrow keys to move to the FKeys entry on the menu. Press [**ENTER**]. The screen now appears similar to Figure 56 below.

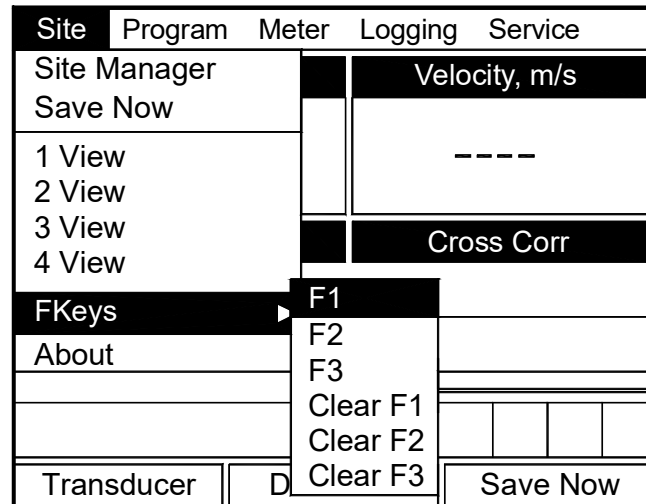

**Figure 56: FKeys Menu**

- Use the [**▼**] or [**▲**] arrow keys to move to the desired FKey (1, 2 or 3) entry on the menu. Press [**ENTER**]. The Configure FKey window opens, as shown in Figure 57 on page 77.

### Customizing Softkeys (cont.)

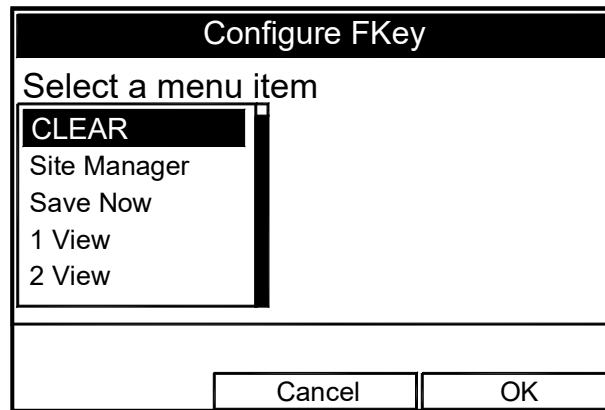
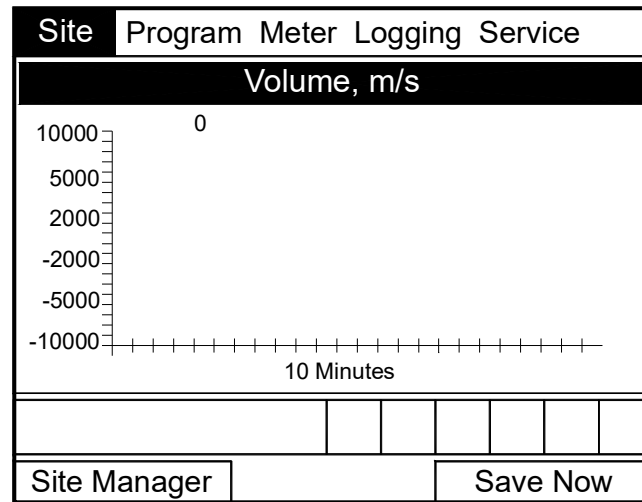

**Figure 57: Configure FKey Window**

3. Use the [▼] or [▲] arrow keys to scroll to the desired submenu (for example, Site Manager).
4. Press **[ENTER]** to confirm the entry, and press **[F3]** (OK) to confirm the entry and close the window. (Press **[F2]** (Cancel) to close the window without changing the key.)

The screen now appears similar to Figure 58 on page 78, with the **[F1]** window displaying “Site Manager.” Pressing **[F1]** opens the Site Manager window.

- To customize a softkey from a particular menu:
  1. Open the desired menu on the Menu Bar (see other chapters for details on particular menus) and scroll to the desired option.
  2. Press the desired softkey. A window appears with the question, “Assign current menu command to FKeyX?”
  3. Press **[F3]** (Yes) to confirm the assignment and close the window. (Press **[F2]** (No) to close the window without changing the key.)

**Customizing Softkeys (cont.)****Figure 58: Display Screen with Modified Softkey**

- To clear a softkey:

1. From the Site Menu (shown in Figure 54 on page 74), use the [▼] or [▲] arrow keys to move to the FKeys entry on the menu. Press **[ENTER]**. The screen now appears similar to Figure 56 on page 76.
2. Use the [▼] or [▲] arrow keys to move to the desired Clear FKey (1, 2 or 3) entry on the menu. Press **[ENTER]**.

The softkey window clears. You can also clear the softkey through the Configure FKey window, by selecting (Clear) as an entry, pressing **[ENTER]** and then **[F3]** (OK).

**Note:** Since the customized softkeys are saved globally, they will remain, even if you change site files.

#### 4.1.2.6 Accessing Meter Data –The About Option

The About option displays useful information concerning the model number and software version of any given CTF878. While the window normally appears briefly at startup, users might want to access the information for a longer period. To open the About window, scroll to the About option on the Site Menu and press **[ENTER]**. The screen appears similar to Figure 59 below. To access data on your specific CTF878, press [F2] (Next).

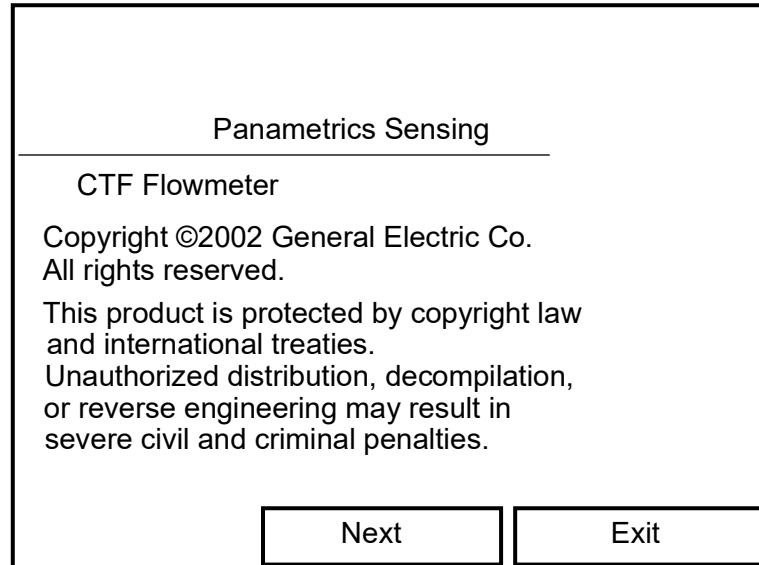

**Figure 59: The About Window**

To return to Operate Mode, press **[ESC]** or **[F3]** (Exit).

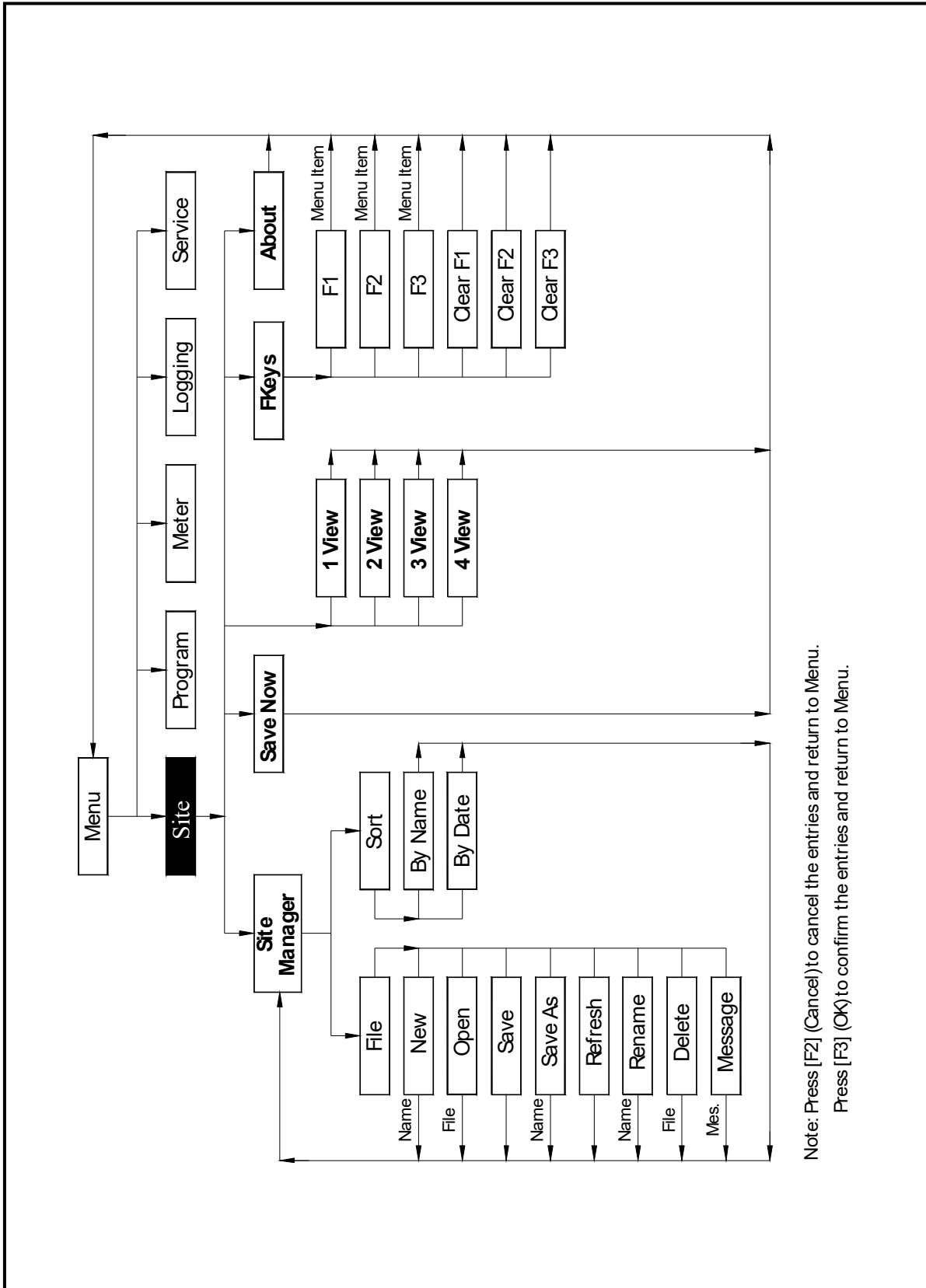

Note: Press [F2] (Cancel) to cancel the entries and return to Menu.  
 Press [F3] (OK) to confirm the entries and return to Menu.

Figure 60: Site Menu Map



---

## Chapter 5.

### 5.1 Specifications

#### 5.1.1 Features

##### 5.1.1.1 Built-In Flow Computer

- Programmable from the keypad.
- Outputs velocity and other flow parameters in real time, while simultaneously handling other activities such as programming, logging, calibration and output of data and diagnostics.

##### 5.1.1.2 Data Logging

- Memory capacity for over 6,900 data points in linear or circular format for standard and error logs.
- Keypad programmable for log units, log interval, and start and stop times.

##### 5.1.1.3 Display Functions

- Graphic display shows flow in numeric or graphic format.
- Also displays logged data and diagnostics.

##### 5.1.1.4 PC-Interface Software

- PanaView™ Instrument Interface Software option links the CTF878 to a PC computer. Package includes CD-ROM, interconnection cable (please specify type needed), and manual.

##### 5.1.1.5 Volumetric Flow Rate

- Actual Volumetric Flow Rate
- Standard (Ideal Gas) Volumetric Flow Rate w/ temperature and pressure inputs.

## 5.1.2 General System Specifications

### 5.1.2.1 Hardware Configuration

#### **Channel Options:**

Single channel.

#### **Transducer / Preamplifier Options:**

3" North America gual box termination for all four transducers.

3" ATEX gual box termination for all four transducers.

### 5.1.2.2 Package Options:

*Standard:* Epoxy-coated aluminum

*Optional:* Stainless Steel or Explosion-Proof.

### 5.1.2.3 Physical Characteristics

*Standard Size:* 14.24 x 11.4 x 5.12 in. (36.2 x 29 x 13 cm)

*Standard Weight:* 11 lb (5 kg)

### 5.1.2.4 Flow Range and Accuracy (% of reading)

#### **Pipe Sizes**

3" to 24" (80 mm to 610 mm) ANSI

#### **Velocity Range for Acoustically Conductive Gases**

*Minimum Velocity* = 3.6 ft/sec (1.1 m/s)

*Maximum Velocity* = 150 ft/sec (45.7 m/s)

**Note:** *The CTF878 requires flow to modulate the ultrasonic signal. The meter will go into error at velocities below approximately 3.6 ft/sec, but will resume function if negative flow is established with velocities greater than 3.6 ft/sec in the reverse direction.*

#### **Velocity Accuracy**

2% of reading

#### **Repeatability**

0.6%

#### **Rangeability**

43:1

#### **Update Rate**

2 Seconds

#### **Response Time (to within 2% of final value)**

25–45 Seconds

## 5.1.3 System Electronics Specifications

### 5.1.3.1 User Interface

#### **Keypad**

24-key, rubberized, tactile-membrane keypad

#### **Display**

240 x 200 pixel LCD graphical display w/ backlight

### 5.1.3.2 User I/O

#### **Digital Input/Outputs:**

Standard: RS232

Optional: RS485

#### **Analog Inputs**

Select up to three boards of the following two types (see note below):

*Analog Input Board* with two isolated 4-20mA inputs and 24V loop power

*RTD Input Board* with two isolated 3-wire RTD inputs;  
Span  $-148^{\circ}$  to  $600^{\circ}\text{F}$  ( $-100^{\circ}$  to  $333^{\circ}\text{C}$ )

#### **Analog Outputs**

Standard: Two isolated 0/4-20mA current outputs,  $550\Omega$  max. load

Optional: Select up to three additional output boards, each with four isolated 0/4-20mA outputs,  $1\text{k}\Omega$  maximum load (see note below).

#### **Totalizer/Frequency Outputs**

Select up to three Totalizer/Frequency Output Boards, each with four outputs per board, 10kHz maximum (see note below). All boards allow software selectable functioning in two modes:

*Totalizer Mode*: Pulse per defined unit of parameter (e.g., 1 pulse/ft<sup>3</sup>).

*Frequency Mode*: Pulse frequency proportional to magnitude of parameter (e.g., 10 Hz = 1 ft<sup>3</sup>/min).

#### **Alarm Relays**

Select up to two boards of the following types (see note below):

*General Purpose Relay Board* with three Form-C relays;  
120VAC, 28VDC max., 5A max.; DC 30W max., AC 60VA

*Hermetically Sealed Relay Board* with three hermetically sealed Form-C relays; 120VAC, 28VDC max., 2A max.;  
DC 56W max., AC 60VA.

**Note:** There can be a maximum of six input/output option boards at one time.

#### **Cable Type and Length**

Standard: Set of four coaxial cables, type RG62a/u, 10ft (3m) long.

Optional: Lengths to 500 ft (153 m).

### 5.1.3.3 Power Input

#### **AC Line Options**

*Input Voltage*: 85-264 VAC, 47-63 Hz

*Input Power*: 15-35 watts (option dependent)

*Power Factor*: 0.5

*Peak Inrush Current*: < 1.4 A after 10 ms, 120V 60 Hz  
< 2.5 A after 10 ms, 240V 50 Hz

*Line Dropout Holdup Time*: 10 ms minimum per EN61000-4-11

#### **Protection**

Built-in mains power surge/lightning protection.

### 5.1.3.4 Environmental Requirements

#### **Operating Temperature:**

$14^{\circ}$  to  $130^{\circ}\text{F}$  ( $-10^{\circ}$  to  $55^{\circ}\text{C}$ )

#### **Storage Temperature**

$-40^{\circ}$  to  $158^{\circ}\text{F}$  ( $-40^{\circ}$  to  $70^{\circ}\text{C}$ )

***Operational and Storage Humidity***

0% to 90% RH (Non-Condensing)

***Vibration (Unit)***

10 Hz to 75 Hz Sinewave, 0.020" Peak-to-Peak Displacement

***Vibration (Unit w/ Packaging)***

10 Hz to 75 Hz Sinewave, 0.020" Peak-to-Peak Displacement

**5.1.3.5 Regulatory, Safety, Certifications**

- LVD 950, LVD 1010
- CE Radiated/Conducted, Emissions/Immunity, Burst, Surge, ESD
- Type 4X

## 5.1.4 Transducer, Preamplifier and Fixture Specifications

### 5.1.4.1 Ultrasonic Flow Transducers

#### **Temperature Range**

*C-RS, C-RV, C-RW Transducers' Family:*  $-40^{\circ}$  to  $+302^{\circ}\text{F}$   
 $(-40^{\circ}$  to  $+150^{\circ}\text{C})$

#### **Materials**

Stainless Steel and Plastic

#### **Housing Options:**

*Explosion-Proof* (suitable for Class I, Div. 1, Groups C & D)

Certification pending

*Flameproof* (ATEX CE Ex II G T6, IP68)

Certification pending.

*Weatherproof* (Type 4X, IP65)

### 5.1.4.2 Receive Transducer Preamplifier

#### **Temperature Range**

*Ambient Storage & Operating Temperature:*

$-40^{\circ}$  to  $167^{\circ}\text{F}$  ( $-40^{\circ}$  to  $75^{\circ}\text{C}$ )

*Process Temperature:* (Rated the same as the transducer)

#### **Housing Options**

External Preamplifier mounted inside a 3" North America gual box

External Preamplifier mounted inside a 3" ATEX gual box

### 5.1.4.3 Clamping Fixtures

3 to 6 in. (80 to 152 mm) pipe: CFT-V4

6 to 8 in. (152 to 203 mm) pipe: CFT-V8

8 to 12 in. (203 to 305 mm) pipe: CFT-V12

12 to 30 in. (305 to 762 mm) pipe: CFT-PI

### 5.1.4.4 Transducer Fixtures

*Fixture Materials:* Anodized aluminum blocks with stainless steel  
rod, chain or strap.

*Mounting Couplant:* CPL-16

*Damping Material:* DMP-CTF-pipe size

## **5.1.5 Pipe Specifications**

### **5.1.5.1 Materials**

All metal and plastics. *No lined pipes.*

### **5.1.5.2 Sizes**

3 to 24 in. NB ANSI (80 to 610 mm NB) and larger.

### **5.1.5.3 Wall Thickness**

Up to *SCH 80*. Thicker walled pipes may be possible; consult the factory.

### **5.1.5.4 Pressure Requirements**

Dry air, oxygen, nitrogen or argon  $\geq 14.5$  psia (1 bara)

Sweet natural gas  $\geq 25$  psia (1.7 bara)

## Appendix A.

### A.1 CE Mark Compliance

#### A.1.1 Introduction

For CE Mark compliance, the CTF878 flowmeter must be wired in accordance with the instructions in this appendix.

**IMPORTANT:** *CE Mark compliance is required for all units intended for use in EEC countries.*

#### A.1.2 Wiring

The CTF878 must be wired with the recommended cable, and all connections must be properly shielded and grounded. Refer to Table 3 below for the specific requirements.

**Table 3: Wiring Modifications**

Connection	Cable Type	Termination Modification
Transducer	Armored RG62 a/u or conduit	None - grounded using a cable gland.
Input/Output	22 AWG shielded (e.g. Baystate #78-1197)	Terminate using a cable gland.
	Armored conduit	None - grounded using a cable gland.
Power	14 AWG, 3 conductor, shielded (e.g. Belden #19364)	Terminate using a cable gland.
	Armored Conduit	None - grounded using a cable gland.
Shielding	For CE compliance, power and I/O cables must be shielded. Cables are to be terminated within a cable gland at the CTF878. Shielded cable is not required when installations include metal conduit.	

#### A.1.3 External Grounding

For CE Mark compliance, the electronics enclosure and the transducer fixture must each have an external ground wire attached.

**Note:** *If the CTF878 is wired as described in this appendix, the unit will comply with the EMC Directive 2004/108/EC.*





## Appendix B.

### B.1 Data Records

#### B.1.1 Option Cards Installed

Whenever an option card is installed in one of the CTF878's expansion slots, record the type of card and any additional setup information in the appropriate row of table below.

Slot #	Type of Option Card	Additional Setup Information
0	Analog Outputs (A, B)	
1		
2		
3		
4		

Slot #	Type of Option Card	Additional Setup Information
5		
6		

### B.1.2 Initial Setup Data

After the CTF878 flowmeter has been installed, some initial setup data must be entered via the *User Program*, prior to operation. Record that information in table below.

General Information					
Model #			Reference		
Software Vers.			Date		
Serial #					
Signal Processing Parameters					
Velocity Averaging					
C Corr Avg					
Transducer Parameters			Pipe Parameters		
Std. Trans. #			Pipe Material		
Spec. Trans. #			Pipe O.D.		
Frequency Up			Pipe Wall		
Frequency Dn			Fluid Type	Air / Natural Gas / Other	
TAG path			Cal. Factor		
Transdcr Spacing					
K-factor Table					
K Factor #	Data Source	K-Factor	K Factor #	Data Source	K-Factor
1			13		
2			14		
3			15		
4			16		
5			17		
6			18		
7			19		
8			20		

---

9			21		
10			22		
11			23		
12			24		



<b>A</b>		Data Record	
About Option	79	Initial Setup	90
Alarms Option Card		Option Cards	89
Connecting	36	Data Sources, Changing	73
Fail-Safe Operation	36	Digital Output Option	60
Analog Inputs Option Card		Display	
Connecting	36	Bar Graph	70
Pin Assignments	36	Configuring	69, 74
Rating	36	Line Graph	70
Analog Outputs		Parameters	75
Connecting	34	Screen	42, 74
Entering	57	DMP-1 Damping Material	12, 19
Span (Full Scale) Value	59	DMP-3 Damping Material	20
Terminal Block	34	<b>E</b>	
Zero (Base) Value	58	Electrical Connectors	8
Analog Outputs Option Card		Electronics Console	
Connecting	38	Description	8
<b>B</b>		Locating	8
Bar Graph Display	70	Mounting	8
<b>C</b>		<b>F</b>	
Cable		Fluid Option	55
Serial Port	34	Format Option	70
Transducer	27, 29	<b>G</b>	
Calibration Factor	62	Graph Display	70
CE Mark Compliance	5, 87	<b>I</b>	
CFT-PI Clamping Fixture		Initial Setup	
Damping Material	19	Data Table	90
Installation	16	Minimum Required	41
Locating	16	Input Voltage	9
Mounting	17	Installation	
Preparation	16	CFT-PI Clamping Fixture	16
Sanding the Pipe	16	CFT-V Clamping Fixture	10
Setting the TAG path	16	Pressure Transmitters	32
Setting the Transducer Spacing	16	Temperature Transmitters	32
CFT-V Clamping Fixture	11	<b>K</b>	
Damping Material	12	Keypad	
Installation	10	Description	44
Locating	10	Using	44
Mounting	14	<b>L</b>	
Preparation	11	Limits Option	71
Sanding the Pipe	11	Line Graph Display	70
TAG path	11	Locating	
Yokes	14	CFT-PI Clamping Fixture	16
Clamping Fixture	3	CFT-V Clamping Fixture	10
CFT-PI	16	Pressure Transmitters	32
CFT-V	10	Temperature Transmitters	32
Clearing Softkeys	78	LVD Shroud	8
Configuring the Display	69	LVD Statement	8
Connecting		<b>M</b>	
See Part Name		Measurement Option	73
Connectors, Electrical	8	Measurement Parameters, Changing	73
<b>D</b>		Model number	79
Damping Material			
CFT-PI Clamping Fixture	19		
CFT-V Clamping Fixture	12		
DMP-1	12, 19		
DMP-3	20		
PDJ Pipe Damping Jacket	23		



**W**

Wiring

CE Mark Compliance ..... 87  
 Option Card ..... See Card Name  
 Pressure Transmitters ..... 32  
 RS232 Interface ..... 34  
 RS485 Interface ..... 35  
 Temperature Transmitters ..... 32  
 Terminal Block ..... See Block Name  
 Transducers ..... 27, 29, 31

**Y**

Yokes, Positioning ..... 14

**Z**

Zero (Base) Valuet ..... 58







## Customer Support Centers

### U.S.A.

The Boston Center  
1100 Technology Park Drive  
Billerica, MA 01821  
U.S.A.  
Tel: 800 833 9438 (toll-free)  
978 437 1000  
E-mail: [mstechsupport@bakerhughes.com](mailto:mstechsupport@bakerhughes.com)

### Ireland

Sensing House  
Shannon Free Zone East  
Shannon, County Clare  
Ireland  
Tel: +353 61 470200  
E-mail: [mstechsupport@bakerhughes.com](mailto:mstechsupport@bakerhughes.com)

Copyright 2023 Baker Hughes company.

This material contains one or more registered trademarks of Baker Hughes Company and its subsidiaries in one or more countries. All third-party product and company names are trademarks of their respective holders.

BH010C41 EN B (08/23)

**Baker Hughes** 