

PALM Flat Scanner

for general weld inspection

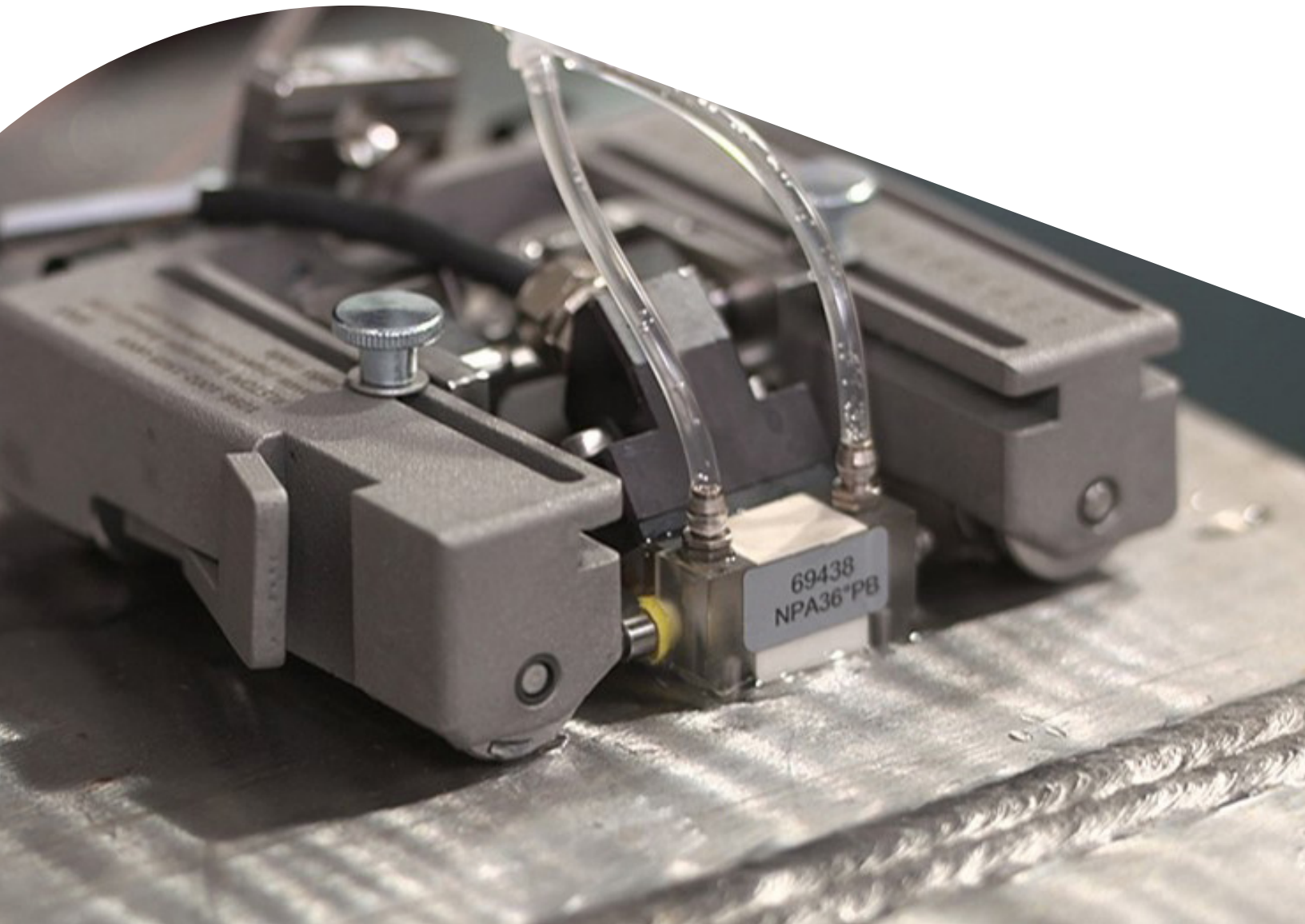

Weld inspections are crucial during the manufacturing process, as well as on a regular basis to ensure weld integrity. Inspections with conventional ultrasonic angle beam probes are time consuming and provide limited documentation. Probability of detection is reduced due to the limited amount of angles used, which could result in missed indications. Waygate Technologies now offers the PALM Flat Scanner to perform more accurate and efficient weld inspections.

PALM Flat Scanner

Encoded Phased-Array inspection of welds offers the benefits of a reduced inspection time, while increasing the probability of detection and providing a comprehensive documentation of the inspection results directly on the instrument. The PALM Flat Scanner is a versatile and ergonomic inspection tool featuring an integrated encoder and magnetic wheels, allowing vertical and overhead operation. The scanner can be used on diameters larger than 90 mm for circumferential scanning and 200 mm for axial scanning.

Features

- Compact, rigid, lightweight and robust (IP67, stainless)
- Low profile to pass clearances as low as 30 mm (1.2") dependent on probe
- Reproducible adjustment of the probe position based on an integrated ruler
- Adaptive to various probes and wedges
- Integrated robust encoder, which can easily be replaced by the operator
- Spring-loading and gimbaling of probes
- Magnetic wheels to stick to tube and for straight guiding
- Manual brake for hand-free locking at any position
- Easy switching from axial to circumferential direction and back
- Operable by a single person
- Easy to set up
- CE compliant

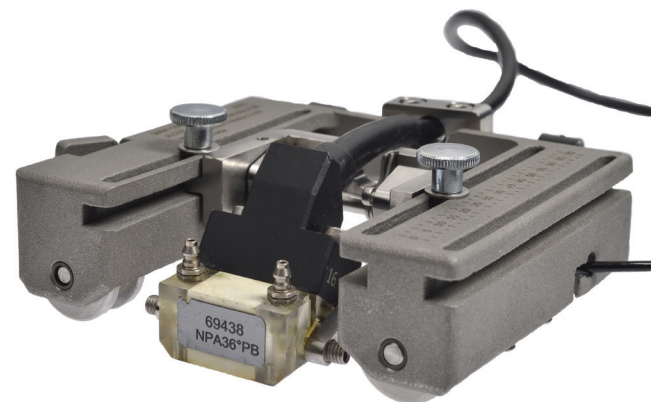

Operating information

The PALM Flat Scanner— part of the PALM Scanner family – circumferentially inspects pipes of diameters from 90 mm (3.5") outer diameter to flat and inner diameters down to 250 mm (10"). The minimum diameter of axial scanning is 200 mm. The tools can carry probes up to the size of 70 mm (length) x 50 mm (width) to suit any inspection procedure regardless of tube thickness, material or acceptance criteria.

The PALM Flat Scanner is delivered with a wide selection of accessories in order to make inspection and/or equipment handling even simpler. With other types of probes, the PALM Flat Scanner has the potential to solve many other applications as well. Our solution teams in USA and Europe would be pleased to assist you with special application requests.

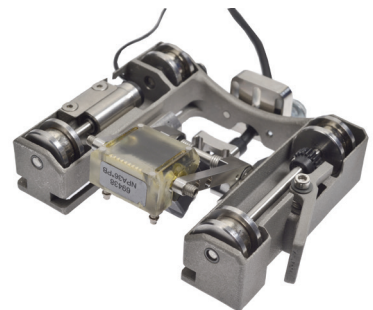

UT scanning results

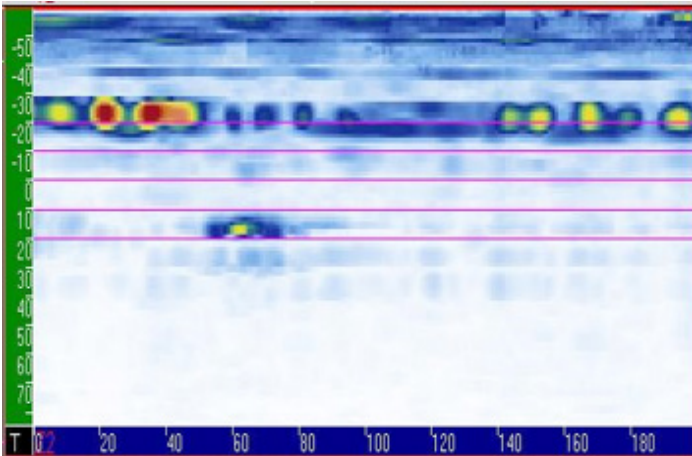

C-scan of weld displaying indications as high reflection signals (red and yellow amplitudes). The weld geometry is displayed in the C-Scan for localization. Cursors are available after the scan for determining the position of indications with respect to the weld geometry.

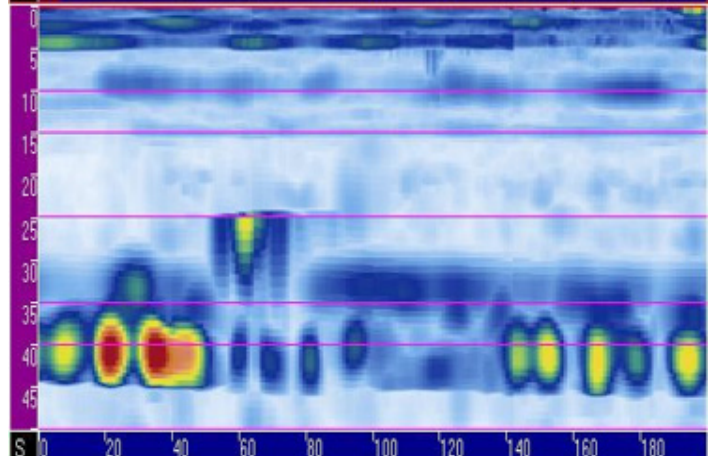

B-scan of weld displaying the depths of indications. The double V weld geometry of a 25 mm thick part is shown. Indications are detected between 1st and 2nd skip in the upper part of the weld at a depth of about 10 mm.

Phased-Array probes

Inspection of welds with a typical material thickness of up to 25 mm

Part number	Connector type	Frequency (MHz)	Element	Pitch (mm)	Aperture (mm)	Elevation (mm)
115-100-001	Tyco (Mentor UT w/MUX)	2	8	1	8x9	9
115-100-002	Tyco (Mentor UT w/MUX)	4	16	0.5	8x9	9
115-110-001	Mentor UT	2	8	1	8x9	9
115-110-002	Mentor UT	4	16	0.5	8x9	9

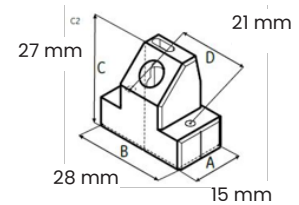

Wedges

Part number	
0600218	NPA36°M (flat)
0600183	NPA36°M R. (A-D)**

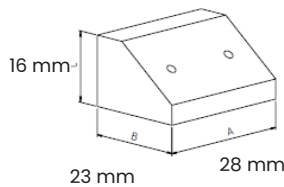

** How to order custom wedge curvatures (see back page)

Instrument specific wedge parameters for 0600218 and 0600183 type „A“ and „B“

Instrument	Material	Sound velocity		Incident angle (deg)	Primary Offset		Height of reference element	
		(m/s)	(in/us)		(mm)	(in)	(mm)	(in)
Phasor	Polystyrol	2380	0.0937	36	17	0.669	10.5	0.413



High frequency focused Phased-Array probes

Inspection of welds with thin material thickness less than 8 mm

Part number	Connector type	Frequency (MHz)	Element	Pitch (mm)	Aperture (mm)	Elevation (mm)	Internal Focus (mm)
115-100-047	Tyco (Mentor UT w/MUX)	7.5	16	0.5	8x10	10	35
115-100-048	Tyco (Mentor UT w/MUX)	10	16	0.4	6.5x7	7	35
115-110-047	Mentor UT	7.5	16	0.5	8x10	10	35
115-110-048	Mentor UT	10	32	0.3	9x7	7	35



Wedges	
0600219	NPA38°M (flat)
0600220	NPA38°M R.. (A-D)**

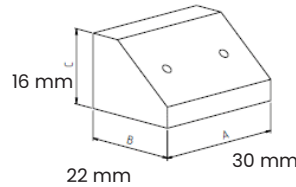

Instrument specific wedge parameters for 0600219 and 0600220 type 'A' and 'B'

Instrument	Material	Sound velocity		Incident angle (deg)	Primary offset		Height of reference element	
		(m/s)	(in/us)		(mm)	(in)	(mm)	(in)
Phasor	Rexolite	2337	0.092	38.5	15.6	0.614	7.6	0.299

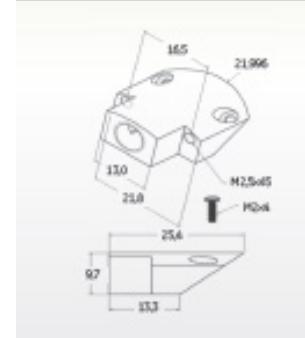

Scanner packages

Scanner packages	
PALM Flat Scanner with case	0600176
Encoder Adapter Mentor UT	0600185

** How to order custom wedge curvatures

Applies only to part numbers 0600183 and 0600220.

Choose letter specifying the curvature geometry according to below pictures.

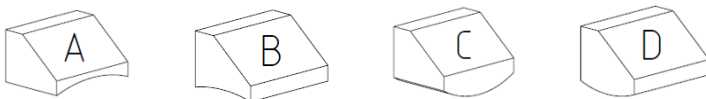

When placing the order use the curvature specification and radius of the curvature to specify the wedge.

Example: ordering 0600183 NPA36°M R.. (A-D) in curvature geometry "A" with 60 mm radius.

Use the following identifier when ordering

0600183 NPA36°M R60 A