



PanaFlow™ XMT1000

User's manual

910-313 Rev. A

PanaFlow™ XMT1000

Panametrics liquid flow ultrasonic transmitter

User's manual

910-313 Rev. A
June 2017

[no content intended for this page]

Contents

Product registration	vii
Services	vii
Terms and conditions	vii
Typographical conventions	vii
Safety issues	vii
Auxiliary equipment	viii
Environmental compliance	viii
Chapter 1. Installation.....	1
1.1 Introduction	1
1.2 CE marking compliance	1
1.3 Unpacking the XMT1000.....	2
1.4 Site and clearance considerations	3
1.4.1 Access to the meter.....	3
1.4.2 Vibration exposure considerations.....	3
1.4.3 Sunlight exposure.....	3
1.4.4 Local mounting	4
1.4.5 Remote mounting.....	4
1.4.6 Cable lengths	4
1.4.7 Transducer cables	4
1.5 Making the electrical connections	5
1.5.1 Wiring the analog outputs	5
1.5.2 Wiring the digital output	6
1.5.3 Wiring the modbus/service port	6
1.5.4 Wiring the line power.....	7
Chapter 2. Programming	9
2.1 Introduction	9
2.2 Using the magnetic keypad.....	9
2.3 Passcodes	9
2.4 Glossary of terms	10
2.5 Menu maps.....	11
Chapter 3. Error codes and troubleshooting	19
3.1 Error display in the user interface	19
3.1.1 Error header.....	19
3.1.2 Communication error string	19
3.1.3 Flow error string.....	20
3.2 Diagnostics	21
3.2.1 Introduction.....	21
3.2.2 Flowcell problems.....	21
3.2.3 Transducer/buffer problems	22

Appendix A. Specifications	23
A.1 Operation and performance	23
A.2 Electronics	24
Appendix B. Modbus communication	25
B.1 Modbus protocol	25
B.2 Modbus register map	25
Appendix C. HART communication	48
C.1 Wiring the XMT1000 to the HART communicator	48
C.2 HART write mode switch	48
C.3 HART menu maps	49
C.3.1 HART output menu map	49
C.3.2 HART review menu map	50
Appendix D. Foundation fieldbus communication	51
D.1 Introduction	51
D.2 Installation	51
D.2.1 Network configuration	51
D.2.2 Polarity	51
D.2.3 Connection	51
D.2.4 FISCO (fieldbus intrinsically safe concept)	52
D.2.5 DD file	52
D.2.6 Default node address	52
D.3 Specifications	53
D.3.1 General	53
D.3.2 Physical	53
D.3.3 Communication	53
D.3.4 User Layer	53
D.3.5 Function blocks	53
D.4 Resource block	54
D.4.1 FF revision	54
D.4.2 Password	54
D.4.3 NAMUR NE107	55
D.5 XMIT transducer block	57
D.5.1 Units	58
D.6 Composite transducer block	59
D.6.1 Clearing the totalizer	61
D.7 Channel transducer block	62
D.8 Analog input block	63
D.9 PID block	63
D.10 Error handling	63
D.11 Simulation mode	64
D.12 Fieldbus troubleshooting guide	65

Product registration

Thank you for purchasing a model PanaFlow™ XMT1000 from Panametrics. Please register your product at <https://info.bakerhughesds.com/New-product-registration-LP.html> product support such as the latest software/firmware upgrades, product information and special promotions.

Services

Panametrics provides customers with an experienced staff of customer support personnel ready to respond to technical inquiries, as well as other remote and on-site support needs. To complement our broad portfolio of industry-leading solutions, we offer several types of flexible and scalable support services including: training, Product repairs, service Agreements and more. Please visit change to: <https://www.bakerhughesds.com/panametrics/services> for more details.

Terms and conditions

Panametrics' sales terms and conditions for your recent purchase of a Panametrics product, including the applicable product warranty, can be found on our website at the following link: <https://www.bakerhughesds.com/sales-terms-conditions>.

Typographical conventions

Note: These paragraphs provide information that provides a deeper understanding of the situation, but is not essential to the proper completion of the instructions.

IMPORTANT:

These paragraphs provide information that emphasizes instructions that are essential to proper setup of the equipment. Failure to follow these instructions carefully may cause unreliable performance.



CAUTION!

This symbol indicates a risk of potential minor personal injury and/or severe damage to the equipment, unless these instructions are followed carefully.



WARNING!

This symbol indicates a risk of potential serious personal injury, unless these instructions are followed carefully.

Safety issues



WARNING!

It is the responsibility of the user to make sure all local, county, state and national codes, regulations, rules and laws related to safety and safe operating conditions are met for each installation.



Attention European customers!



To meet CE marking requirements for all units intended for use in the EU, all electrical cables must be installed as described in this manual.

Auxiliary equipment

Local safety standards

The user must make sure that he operates all auxiliary equipment in accordance with local codes, standards, regulations, or laws applicable to safety.

Working area

	<p>WARNING!</p> <p>Auxiliary equipment may have both manual and automatic modes of operation. As equipment can move suddenly and without warning, do not enter the work cell of this equipment during automatic operation, and do not enter the work envelope of this equipment during manual operation. If you do, serious injury can result.</p>
	<p>WARNING!</p> <p>Make sure that power to the auxiliary equipment is turned OFF and locked out before you perform maintenance procedures on this equipment.</p>

Qualification of personnel

Make sure that all personnel have manufacturer-approved training applicable to the auxiliary equipment.

Personal safety equipment

Make sure that operators and maintenance personnel have all safety equipment applicable to the auxiliary equipment. Examples include safety glasses, protective headgear, safety shoes, etc.

Unauthorized operation

Make sure that unauthorized personnel cannot gain access to the operation of the equipment.

Environmental compliance

RoHS

The PanaFlow™ XMT1000 fully complies with RoHS regulations (Directive 2011/65/EU).

Waste Electrical and Electronic Equipment (WEEE) directive

Panametrics is an active participant in Europe's Waste Electrical and Electronic Equipment (WEEE) take-back initiative (Directive 2012/19/EU).



The equipment that you bought has required the extraction and use of natural resources for its production. It may contain hazardous substances that could impact health and the environment.

In order to avoid the dissemination of those substances in our environment and to diminish the pressure on the natural resources, we encourage you to use the appropriate take-back systems. Those systems will reuse or recycle most of the materials of your end life equipment in a sound way.

The crossed-out wheeled bin symbol invites you to use those systems.

If you need more information on the collection, reuse and recycling systems, please contact your local or regional waste administration.

Please visit <https://www.bakerhughesds.com/health-safetyand-environment-hse> for take-back instructions and more information about this initiative.

Chapter 1. Installation

1.1 Introduction

To ensure safe and reliable operation of the XMT1000, it must be installed in accordance with the established guidelines. Those guidelines, explained in detail in this chapter, include the following topics:

- Unpacking the XMT1000
- Selecting the location for the XMT1000 (local or remote)
- Installing the XMT1000 at the selected location
- Wiring the XMT1000



WARNING!

The XMT1000 flow transmitter can measure the flow rate of many fluids, some of which are potentially hazardous. The importance of proper safety practices cannot be overemphasized.

Be sure to follow all applicable local safety codes and regulations for installing electrical equipment and working with hazardous fluids or flow conditions. Consult company safety personnel or local safety authorities to verify the safety of any procedure or practice.



Attention European customers!

To meet CE marking requirements, all cables must be installed as described in "CE marking compliance."

1.2 CE marking compliance

For CE marking compliance or installation in high noise areas, the XMT1000 flow transmitter must be wired in accordance with the instructions in this section.

IMPORTANT:

CE marking compliance is required for all units intended for use in EU countries.

The XMT1000 must be wired with the recommended cable, and all connections must be properly shielded and grounded. Grounding of the chassis must be within 10 ft (3 m) of the transmitter. Refer to *table 1* below for the specific requirements.

Table 1: Wiring requirements

Connection	Cable type	Ground termination
Transducer	Armored RG-62 a/U or equivalent	Grounded using a cable gland
Input/output	Armored 22 AWG shielded with armored material added to outside of jacket	Grounded using a cable gland
Power	Armored 14 AWG 2 conductor	Grounded using a cable gland

Note: If the XMT1000 is wired as described above, the unit will comply with the EMC and LVD Directives.

1.3 Unpacking the XMT1000

Before removing the XMT1000 from its box, please inspect both the box and the instrument carefully. Each instrument manufactured by Panametrics is warranted to be free from defects in material and workmanship. Before discarding any of the packing materials, account for all components and documentation listed on the packing slip. The discarding of an important item along with the packing materials is all too common.

If anything is missing or damaged, contact Panametrics Customer Care immediately for assistance.

The XMT1000 is supplied with both a serial number label and a certification label for identification of the instrument (see *figure 1* below and *figure 2*). The system can be mounted either on an existing meter body (*local mounting*) or at another location via a connecting cable (*remote mounting*).

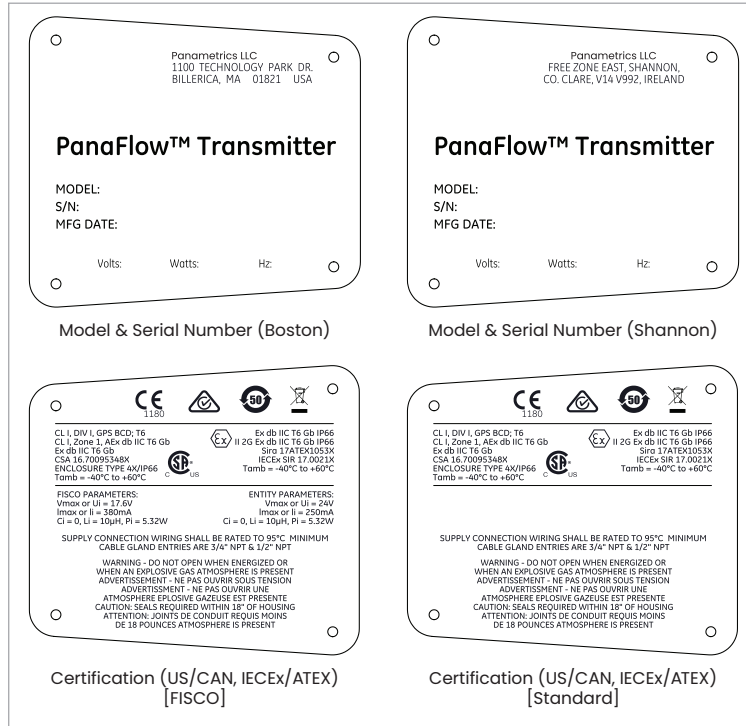

Figure 1: Typical XMT1000 labels (aluminum enclosure)

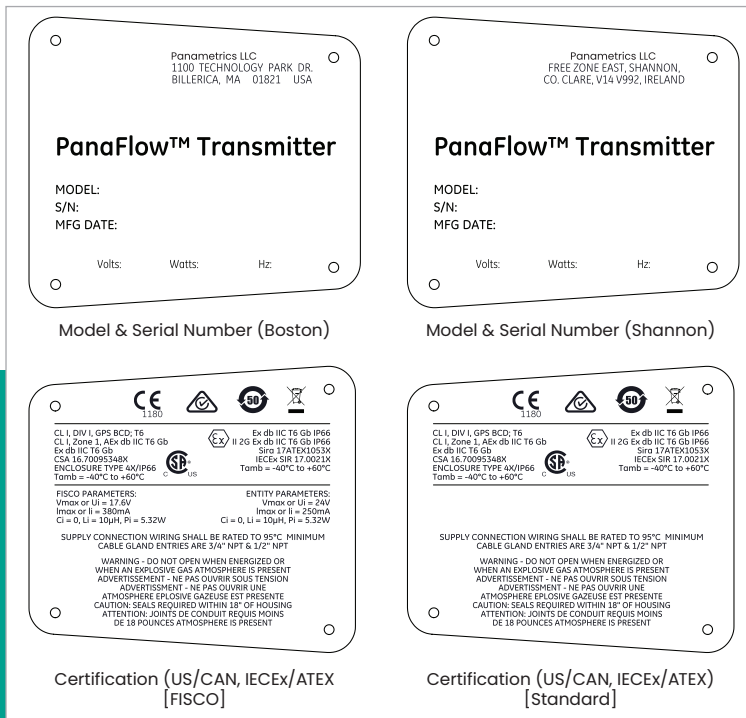

Figure 2: Typical XMT1000 labels (stainless steel enclosure)

1.4 Site and clearance considerations

1.4.1 Access to the meter

Because the relative location of the flowcell and the XMT1000 transmitter is important, use the guidelines in this section to plan the XMT1000 installation.

For flowcell clearance recommendations, consult the manual for your specific flow meter system or contact Panametrics for assistance. Access to the XMT1000 flow transmitter should be uninhibited, as defined by the minimum clearance distances around the enclosure specified in *figure 3*.

1.4.2 Vibration exposure considerations

Whenever possible, install the XMT1000 flow transmitter in a location isolated from vibrations. Avoid installing it near equipment that generates low-frequency, high-energy random vibrations.

1.4.3 Sunlight exposure

The installer should consider and limit exposure of the XMT1000 flow transmitter to direct sunlight. Sunshades should be utilized in extreme environments.

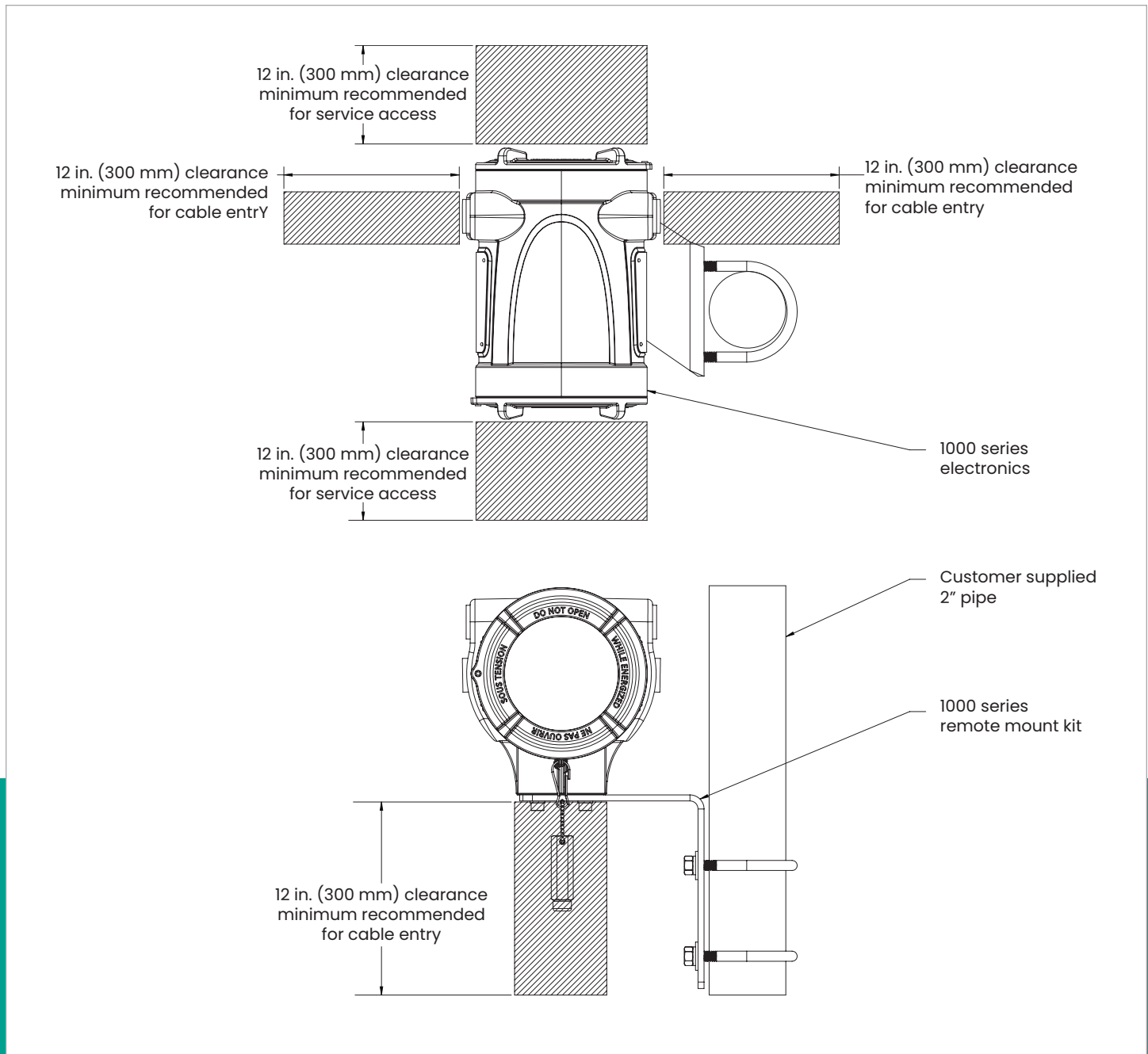



Figure 3: XMT1000 Enclosure clearances (ref. dwg. 712-2164)

1.4.4 Local mounting

The XMT1000 accuracy is affected by the flowcell location in the process piping and on the orientation of the transducers. Thus, in addition to accessibility for maintenance, adhere to the following installation guidelines:

- Locate the flowcell so that there are at least 10 pipe diameters of straight, undisturbed flow upstream and 5 pipe diameters of straight, undisturbed flow downstream from the measurement point (see figure 4). Undisturbed flow means avoiding sources of turbulence in the fluid (e.g., valves, flanges, expansions, elbows, etc.), avoiding swirl, and avoiding cavitation.
- Locate the transducers on a common axial plane along the pipe. Also, locate them on the side of the pipe instead of on the top or the bottom, because the top of the pipe tends to accumulate gas and the bottom tends to accumulate sediment. Either condition will cause unwanted attenuation of the ultrasonic signals. There is no similar restriction with vertical pipes, as long as the fluid flow is upward to prevent free falling of the fluid or a less than full pipe (see figure 5).



CAUTION!

Do not place thermal insulation on or around the transducers, the junction boxes, or the meter electronics. The transducer and junction box act as a heat sink that protects the transducer from high and low temperatures.

1.4.5 Remote mounting

The standard XMT1000 enclosure is a powder-coated, aluminum, IP67 explosion-proof enclosure. Typically, the enclosure is mounted as close as possible to the transducers. When choosing a site for a remote-mount installation, which is recommended for process temperatures exceeding 150°C, make sure the location permits easy access to the enclosure for programming, maintenance and service.



Attention European customers!

For compliance with the European Union's low voltage directive, this unit requires an external power disconnect device such as a switch or circuit breaker. The disconnect device must be marked as such, clearly visible, directly accessible, and located within 1.8 m (6 ft) of the unit.

1.4.6 Cable lengths

Locate the XMT1000 as close as possible to the transducers. The maximum distance from the transducers for remote mounting of the XMT1000 is 1000 ft (300 m) using RG-62 coaxial cable or equivalent. If longer distances are required, consult the factory for assistance.

1.4.7 Transducer cables

When installing the transducer cables, always observe established standard practices for the installation of electrical cables. Do not route transducer cables alongside high amperage AC power lines or any other cables that could cause electrical interference. Also, protect the transducer cables and connections from the weather and corrosive atmospheres, and be sure to follow the manufacturer's installation guidelines if cable glands are provided.

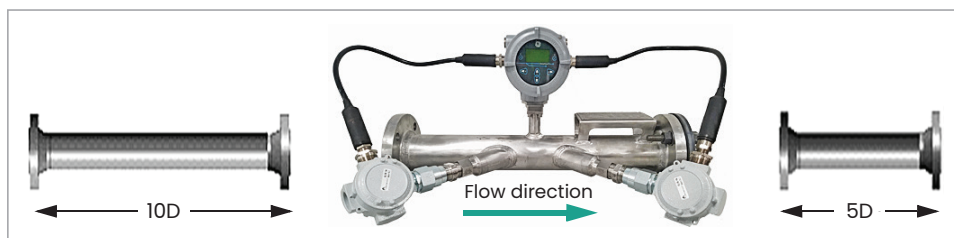

Figure 4: Minimum straight run pipe requirements

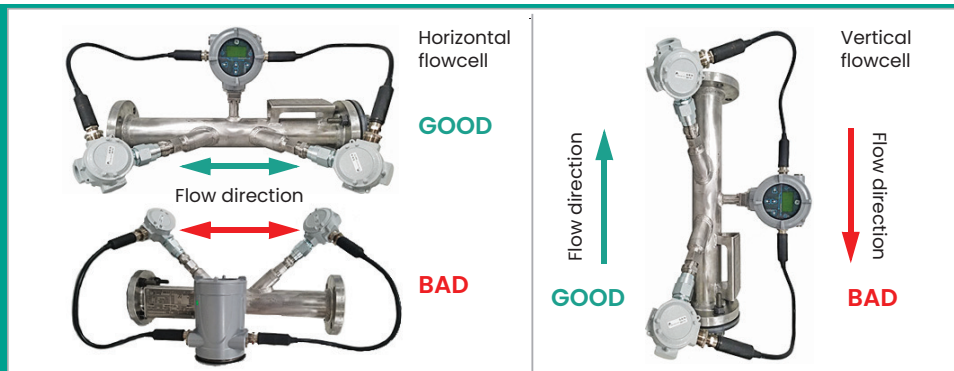

Figure 5: Good and bad flowcell/transducer orientations

1.5 Making the electrical connections

This section contains instructions for making all the necessary electrical connections for the XMT1000 flow transmitter. Refer to *figure 6* for a complete wiring diagram.

Note: Both flying lead and MCX transducer connectors are shown in the figure for completeness. Only the type of connector appropriate for each meter ordered will be installed on the PCB.



WARNING!

Always disconnect the line power from the XMT1000 before removing either the front cover or the rear cover. This is especially important in a hazardous environment.



Attention European customers!

To meet CE Marking requirements, all cables must be installed as described in "CE marking compliance."

Prepare the XMT1000 for wiring by completing the following steps:

- To access the wiring terminals, complete the following steps:
 1. Disconnect any previously wired power line from the unit.
 2. Loosen the set screw on the wiring cover.
 3. Place a rod or long screwdriver across the cover in the slots provided, and rotate the cover counterclockwise until it comes free from the enclosure.
 4. Install any required cable glands in the appropriate conduit holes on the opposite side of the enclosure.

5. Note the labels inside the rear cover to assist in wiring the power and option connections.

- Wiring any option set requires completion of the following general steps:
 1. Disconnect the main power from the unit and remove the wiring cover.
 2. Install a cable gland in the chosen conduit hole on the side of the electronics enclosure and feed a standard *26-12 AWG twisted-pair cable* through this conduit hole.
 3. Locate the *standard I/O or analog I/O options* terminal block and wire the option as indicated on the label inside the wiring cover. Secure the cable gland.
 4. If wiring of the unit has been completed, reinstall the wiring cover on the enclosure and tighten the set screw.



WARNING!

Proper grounding of the XMT1000 enclosure via the external grounding screw on the enclosure (see *figure 6*) is required to prevent the possibility of electric shock. All ground screws should be hand tightened only, to a maximum allowable torque of 2.5 N-m (22 in-lb).

For specific instructions on wiring a particular output configuration, proceed to the appropriate sub-section.

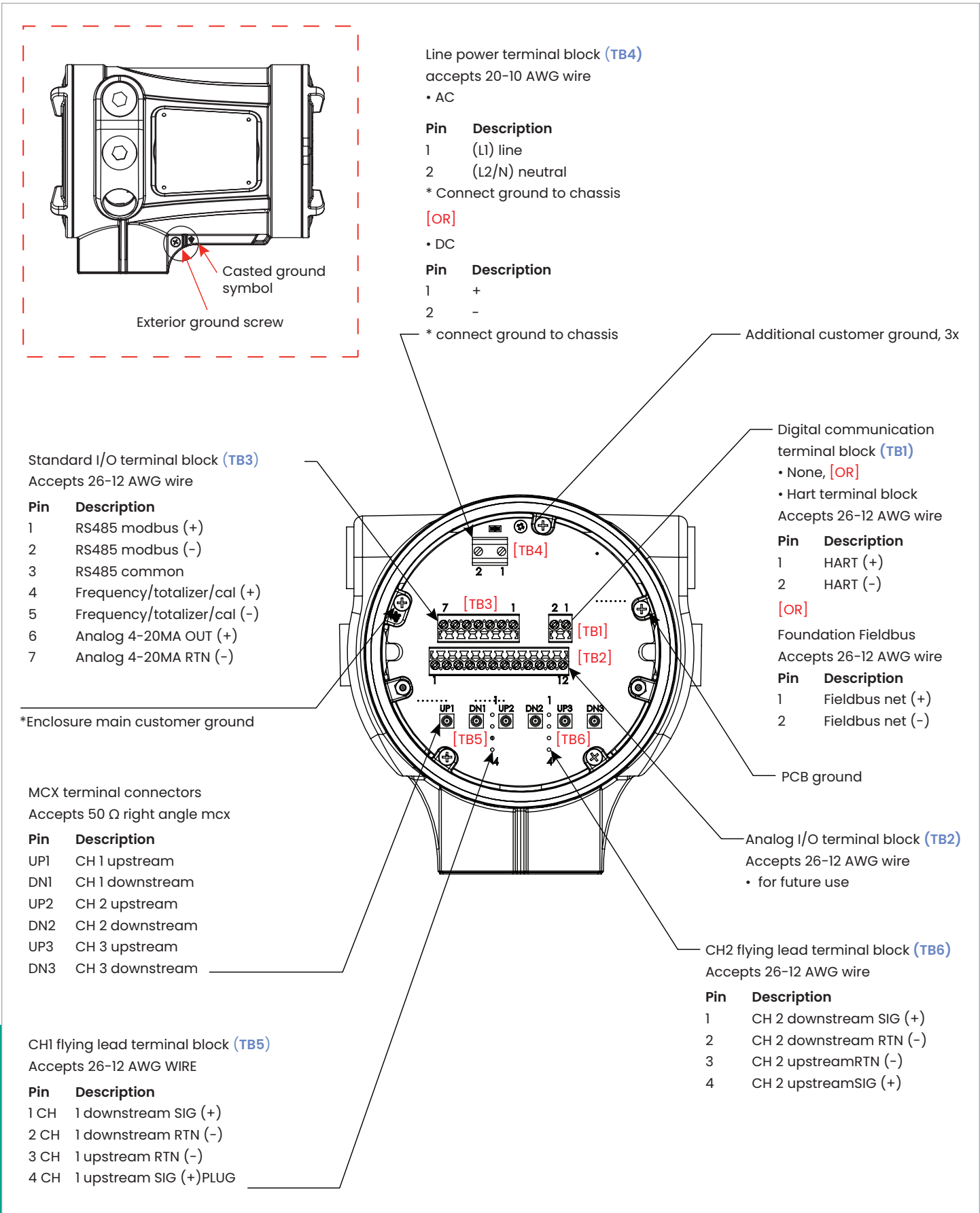

Figure 6: XMT1000 Terminal Board Wiring Diagram (ref. dwg. 702-2040)

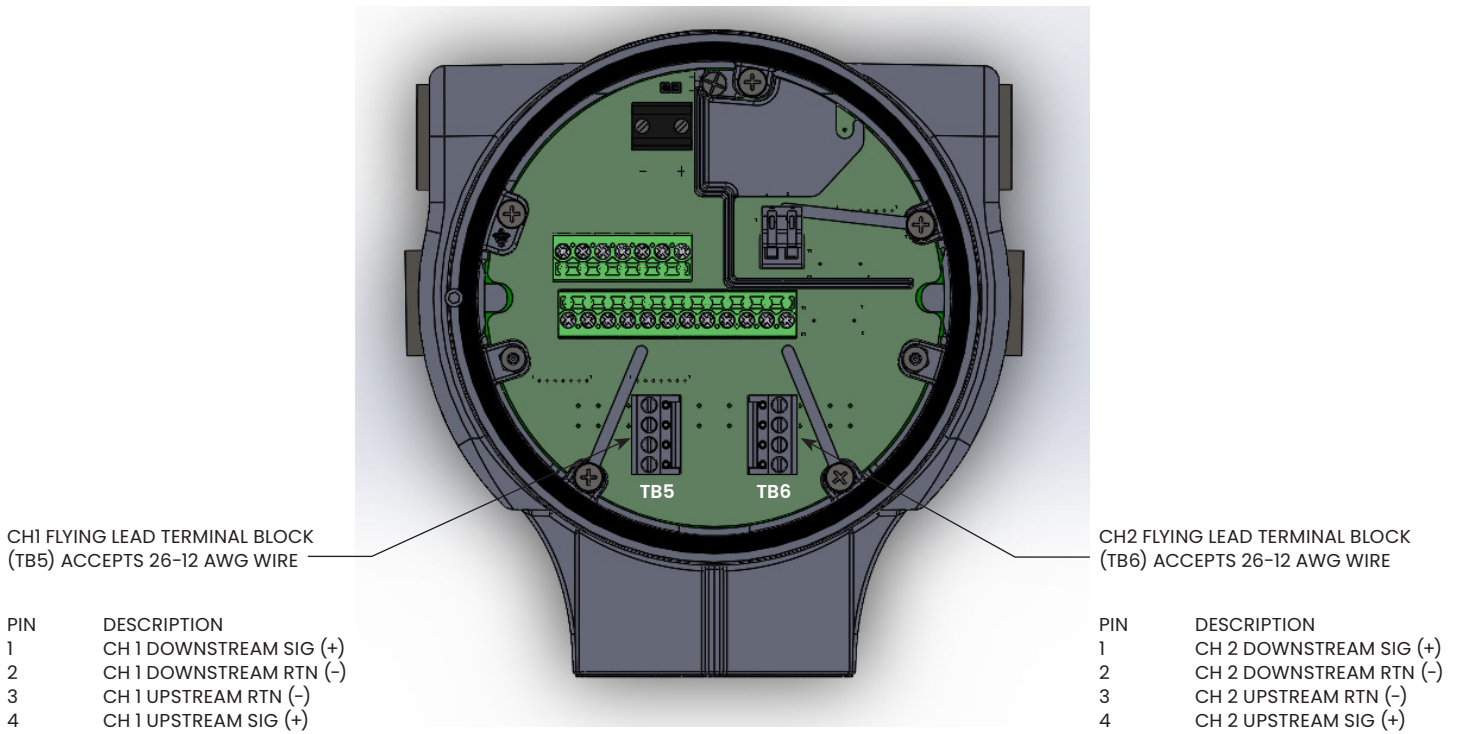

Figure 7: XMT1000 Terminal Block 5 and 6 Wiring Diagram

1.5.1 Wiring the analog outputs

The standard configuration of the XMT1000 flow transmitter includes one isolated 4-20 mA analog output. Connections to this output may be made with standard twisted-pair wiring, but the current loop impedance for this circuit must not exceed 600 ohms. Two additional analog outputs are available as an option.

To wire the analog outputs, complete the following steps:

1. Disconnect the main power to the unit and remove the wiring cover.
2. Install the required cable gland in the chosen conduit hole on the side of the electronics enclosure.
3. Refer to figure 6 on page 8 for the location of the terminal block and wire the analog output as shown. Secure the cable gland.



Attention European customers!

To meet CE marking requirements, all cables must be installed as described in "CE marking compliance."

IMPORTANT:

Analog output A is an active signal. Do not supply power to this circuit, as the circuit is powered by the flow meter.

4. If wiring of the unit has been completed, reinstall the wiring cover on the enclosure and tighten the set screw.

WARNING!



Make sure all covers, with their o-ring seals, are installed and the set screws tightened before applying power in a hazardous environment.

Note: Prior to use, the analog output must be set up and calibrated. Proceed to the next section to continue the initial wiring of the unit.

Note: See *Appendix A, specifications*, for the load and voltage requirements.

1.5.2 Wiring the digital output

The standard XMT1000 flow transmitter configuration includes one isolated digital output, which can be used as a totalizer (pulse) output, a frequency output, or a calibration port. Wiring this output requires completion of the following general steps:

1. Disconnect the main power to the unit and remove the wiring cover.
2. Install the required cable gland in the chosen conduit hole on the side of the electronics enclosure.
3. Refer to *figure 6* for the location of the terminal block and wire the digital output as shown. Secure the cable gland.



Attention European customers!

To meet CE marking requirements, all cables must be installed as described in "CE marking compliance."

- If wiring of the unit has been completed, reinstall the wiring cover on the enclosure and tighten the set screw.

1.5.2a Wiring as a totalizer (pulse) output

Wire this option in accordance with the connections shown on the label in the rear cover (see *figure 6*). Refer to Appendix A, *specifications* for the load and voltage requirements.

1.5.2b Wiring as a frequency output

Wire this option in accordance with the connections shown on the label in the rear cover (see *figure 6*). Refer to Appendix A, *specifications* for the load and voltage requirements.

1.5.2c Wiring as a calibration port

The XMT1000 flow transmitter is equipped with a calibration port specifically designed for calibrating the XMT1000. It is wired for a frequency output. To wire to this port, refer to *figure 6* and complete the following steps:

Note: Performing a calibration of the meter requires entering an admin-level password.

- Disconnect the main power to the unit and remove the rear cover.
- Install the required cable gland in the chosen conduit hole on the side of the electronics enclosure.
- Feed one end of the cable through the conduit hole, wire it to the terminal block.
- If wiring of the unit has been completed, reinstall the wiring cover on the enclosure and tighten the set screw.

- Disconnect the main power to the unit and remove the rear cover.
- Install the required cable gland in the chosen conduit hole on the side of the electronics enclosure.
- Feed one end of the cable through the conduit hole, and wire it to the terminal block.
- If wiring of the unit has been completed, reinstall the wiring cover on the enclosure and tighten the set screw.

Note: Prior to use, the serial port must be programmed.



WARNING!

Make sure all covers, with their o-ring seals, are installed and the set screws tightened before applying power in a hazardous environment.



WARNING!

Make sure all covers, with their o-ring seals, are installed and the set screws tightened before applying power in a hazardous environment.

1.5.3 Wiring the modbus/service port

The XMT1000 flow transmitter is equipped with a modbus communication port for either a connection to Vitality (PC software) or to a separate control system. The port is an RS485 interface.

IMPORTANT:

The maximum cable length for an RS485 connection is 4000 ft (1200 m).

To wire to this RS485 serial port, refer to *figure 6* and complete the following steps:

1.5.4 Wiring the CH1 and CH2 Flying Lead

Refer to Figure 6 on page 6 and Figure 7 on page 7 to locate the Channel 1 and Channel 2 flying lead terminal blocks.

To wire the CH 1 flying lead to the terminal block 5, refer to Figure 8 on page 9 and complete the following steps:

1. Disconnect the main power to the unit and remove the rear cover.
2. Install the required cable gland in the chosen conduit hole on the side of the electronics enclosure.
3. Feed one end of the CH 1 downstream RG62 cable red wire through the conduit hole of DN terminal, and wire it to the terminal block.
4. Feed one end of the CH 1 downstream RG62 cable black wire through the conduit hole of RTN terminal below the DN terminal, and wire it to the terminal block.
5. Feed one end of the CH 1 upstream RG62 cable red wire through the conduit hole of UP terminal, and wire it to the terminal block.
6. Feed one end of the CH 1 upstream RG62 cable black wire through the conduit hole of RTN terminal above the UP terminal, and wire it to the terminal block.
7. If wiring of the unit has been completed, reinstall the wiring cover on the enclosure and tighten the set screw. To wire the CH 2 flying lead to the terminal block 6, repeat the above steps.

1.5.5 Wiring the Line Power

The XMT1000 may be ordered for operation with power inputs of either 100–240 VAC or 12–28 VDC. The label on the side of the enclosure lists the meter's required line voltage and power rating. Be sure to connect the meter to the specified line voltage only.

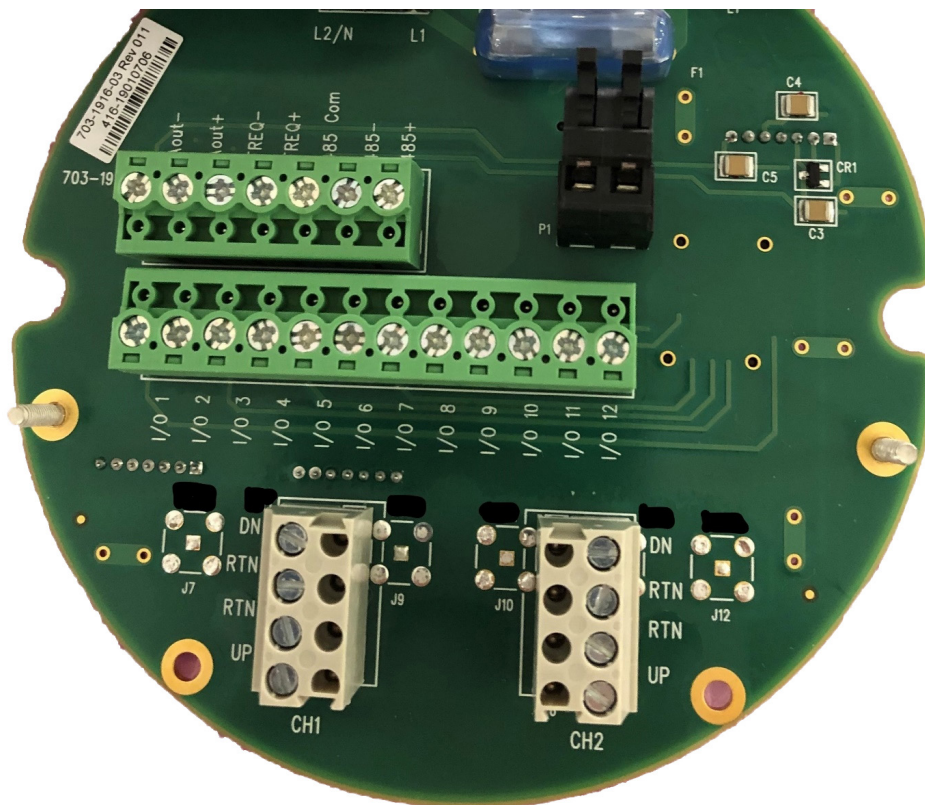

Figure 8: CH1 and CH2 Flying Lead Wiring

Chapter 2. Programming

2.1 Introduction

This chapter provides instructions for programming the various features of the XMT1000 flow transmitter. Before the XMT1000 can begin taking measurements, settings for the *user preferences* and *inputs/outputs* must be entered and tested. To program your XMT1000, see the next section for programming instructions and refer to “*menu maps*” to configure the desired features.

Note: For help with the programming of any system parameters which may be unclear, refer to “*glossary of terms*” for a brief description of the standard flow meter terminology used in this manual.

2.2 Using the magnetic keypad

The display window on the XMT1000 includes the components shown in *figure 7* below.



Figure 9: The display and keypad

IMPORTANT:

The XMT1000 magnetic keypad enables programming of the instrument through the glass faceplate without removing the cover. Thus, all programming procedures may be performed while the unit is installed in a hazardous area.

Above the display, the blue light is for power indication and the red light is for system health indication. Once system power is applied, the blue light stays on until power is lost. The red light blinks when the system is in error. When the red light is off – the system is operating without error.

The six keys on the magnetic keypad are used to program the XMT1000:

- [✓] - confirms the choice of a specific option and data entry within that option
- [X] - enables users to exit from a specific option without entering unconfirmed data
- [△] and [▽] - enable users to highlight a specific window in the display option or to scroll through a list of options (parameters, letters, and numbers, 0–9 as well as the negative sign and decimal point) in a menu
- [◀] and [▶] - enable users to scroll to a specific option, among choices in an option, or to a character in a text entry.

When the XMT1000 is powered up, the initial screen display appears, followed by meter boot up, then by a display of measurement parameters.



As a guide to help follow the programming instructions in this chapter, the XMT1000 menu maps have been reproduced in *figure 8* on through *figure 15*.

IMPORTANT:

If the keypad has not been pressed for 10 minutes, the XMT1000 exits the keypad program and returns to displaying measurements. Because changes can only be retained after the user confirms them, the meter discards any unconfirmed configuration changes.

2.3 Passcodes

The default passcodes for the XMT1000 flow transmitter are:

- Default operator password = 111111
- Default admin password = 111111

IMPORTANT:

The default admin password must be changed before the meter is placed into service, and the new admin password must be properly secured. Unauthorized access to the admin menus may result in programming changes that have a negative impact on the performance and operation of the meter.

2.4 Glossary of terms

- **Backlight:** The LCD display backlight has three user-adjustable parameters. The brightness, the contrast, and the length of inactivity which triggers automatic shutdown can be individually set within available limits.
- **Error handling:** The manner in which various XMT1000 outputs respond to automatically generated system errors can be set by the user by selecting the options from a drop-down list.
- **Frequency output:** In frequency mode, the digital output generates a pulse with a frequency that is proportional to the magnitude of the measured flow parameter (e.g., 10 Hz = 1ft³/hr).
- **HART:** HART is a serial communication protocol used for industrial automation. Its main advantage is that it can communicate over 4-20 mA analog instrumentation current loops over the pair of wires used by the analog only host system.
- **K-factor:** To calibrate the XMT1000 against a reference value, the raw flow velocity readings may need to have a correction factor applied. This *K-factor* can be a single constant or a table of K-factor vs. velocity values.
- **Loop powered:** Loop powered analog devices use the power provided by the meter itself rather than by an external power supply. This results in a simple 2-wire connection between the meter and the external device.
- **Mass flow:** mass flow is the mass of fluid passing the measurement point in a given period of time. This value is calculated by the meter from the measured flow velocity and the programmed pipe and fluid parameters.
- **Modbus:** Modbus is a serial communication protocol developed by Modicon® for use with its programmable logic controllers. It is a method used for transmitting information over serial lines between electronic devices.
- **Pulse output:** In pulse/totalizer mode, the digital output generates a pulse with a width corresponding to one unit of the measured flow parameter (e.g., 1 pulse = 1 ft³).
- **Reynolds correction:** When turned on, a factor based on the *kinematic viscosity* and the *flow rate* of the fluid is applied to all measurements. Reynolds correction should be On for most applications.
- **Serial port settings:** When the XMT1000 serial port is connected to an external serial device, communication between the two devices only occur if the serial port settings of the two devices match. These settings include: *baud rate*, *data bits*, *stop bits*, and *parity*.
- **Special transducer:** If your transducer has no number engraved on the body, select SPECIAL in the transducer number menu.
- **Tw:** The TW parameter is the time the transducer signal spends traveling through the transducer body and the transducer cable. This value must be subtracted from the total signal transit time to calculate the actual signal transit time only through the fluid.
- **Totalizer:** The totalizer accumulates a running total of the amount of fluid which passes the measurement point between specified start and stop times.
- **Tracking window:** The tracking window is used to detect the receive signal when you are unsure of the fluid sound speed. For the XMT1000 flow transmitter, the tracking Window is always ON.
- **Zero cutoff:** When the measured flow rate is below the *zero cutoff* value, the display is forced to 0.00. This is to avoid rapid fluctuations in the reading whenever the flow rate is close to zero.

2.5 Menu maps

Use the menu maps in this section to program the desired XMT1000 features.

- Measurement display menu map (rev. 10)
- Main menu map (rev. 10)
- SYSTEM menu map (rev. 10)
- MAIN Board I/O menu map (rev. 10)
- OPTION Boards menu map (rev. 10)
- SENSOR SETUP menu map (rev. 10)
- CALIBRATION menu map (rev. 10)
- ADVANCED menu map (rev. 10)

In addition, the following menu maps are available in Appendix C:

- HART output menu map
- HART review menu map

IMPORTANT:

Not all users will have access to all of the above menus. Some menus are restricted to only those users with the proper passcodes.

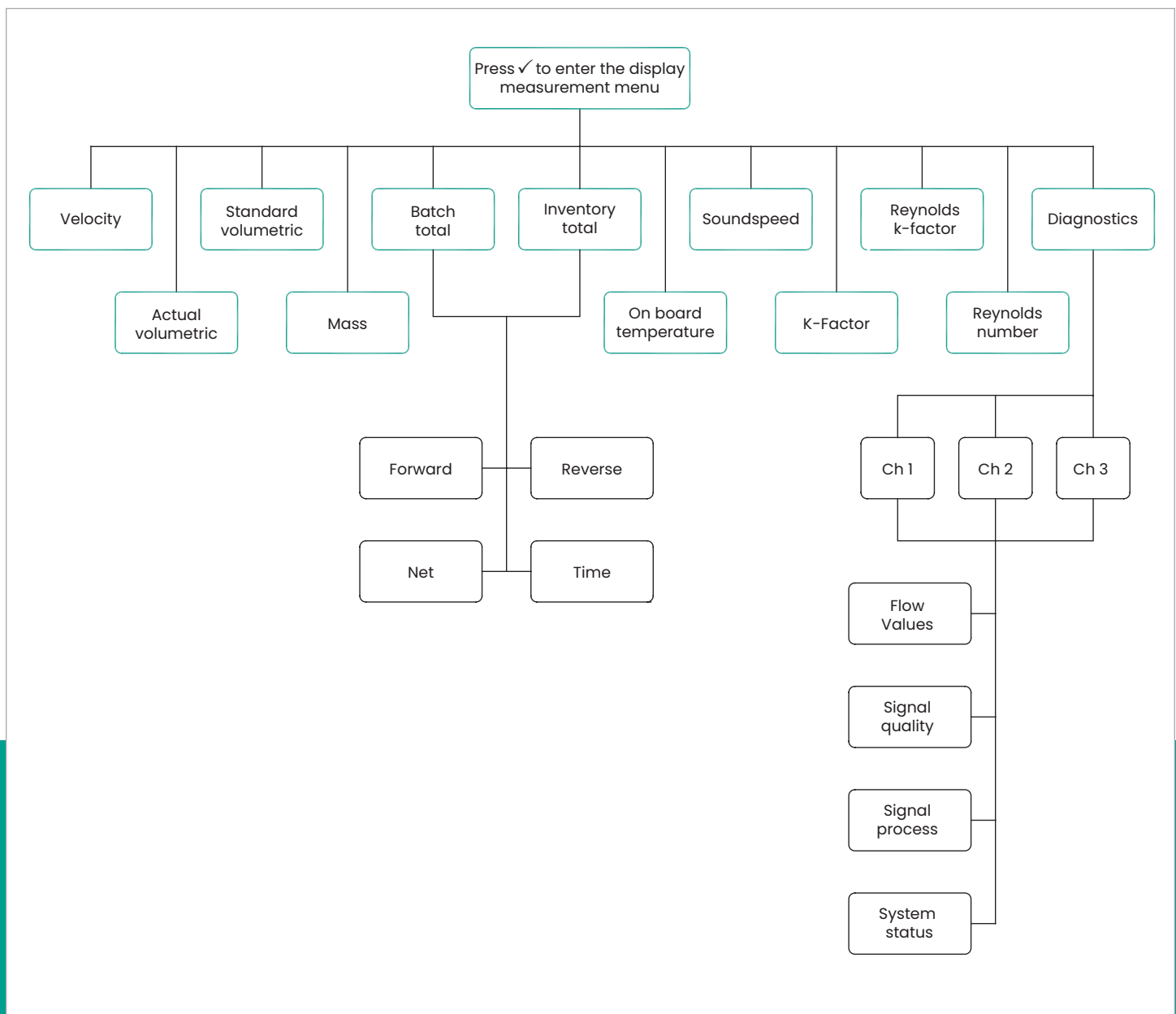

Figure 10: Measurement display menu map (rev. 10)

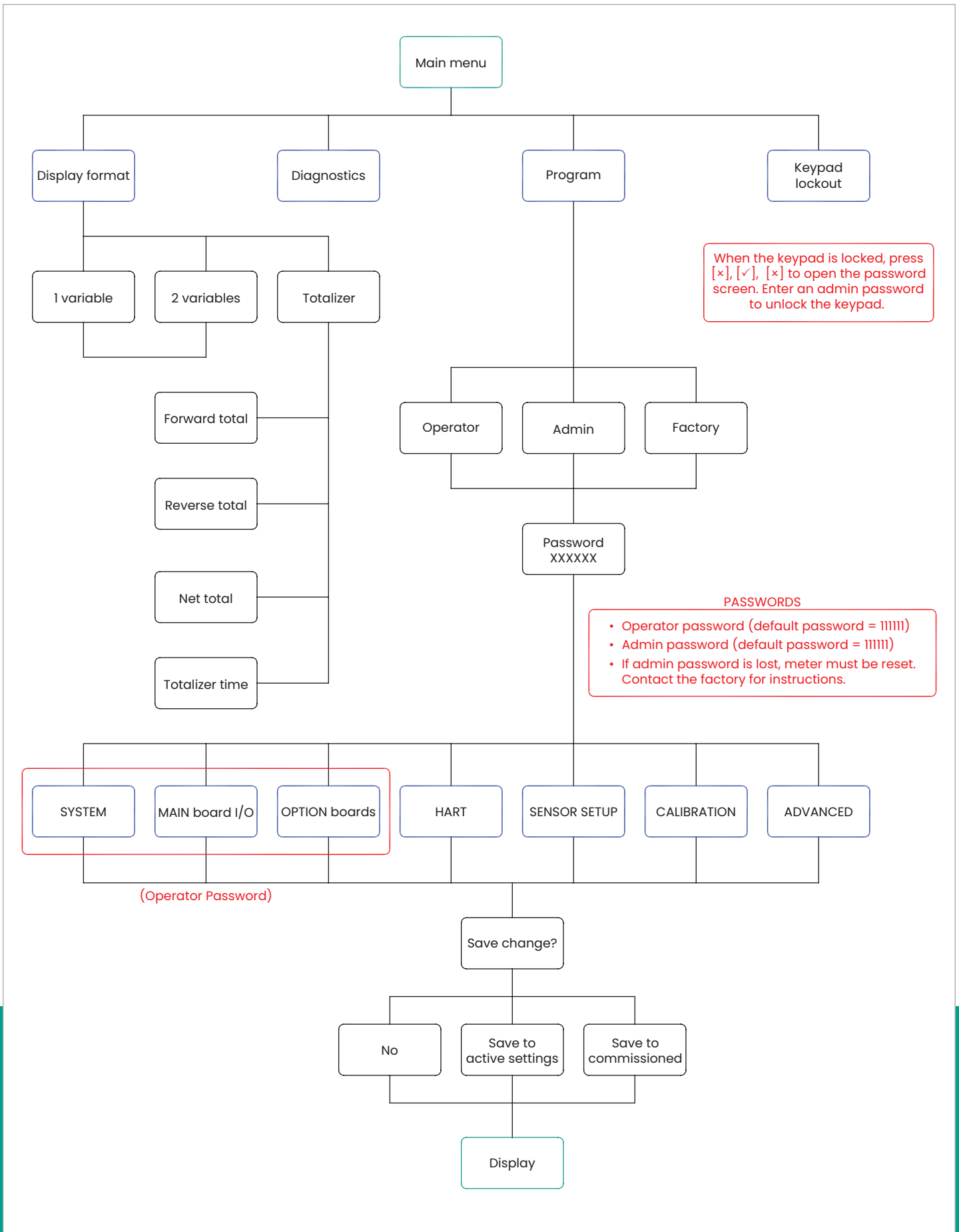

Figure 11: Main menu map (rev. 10)

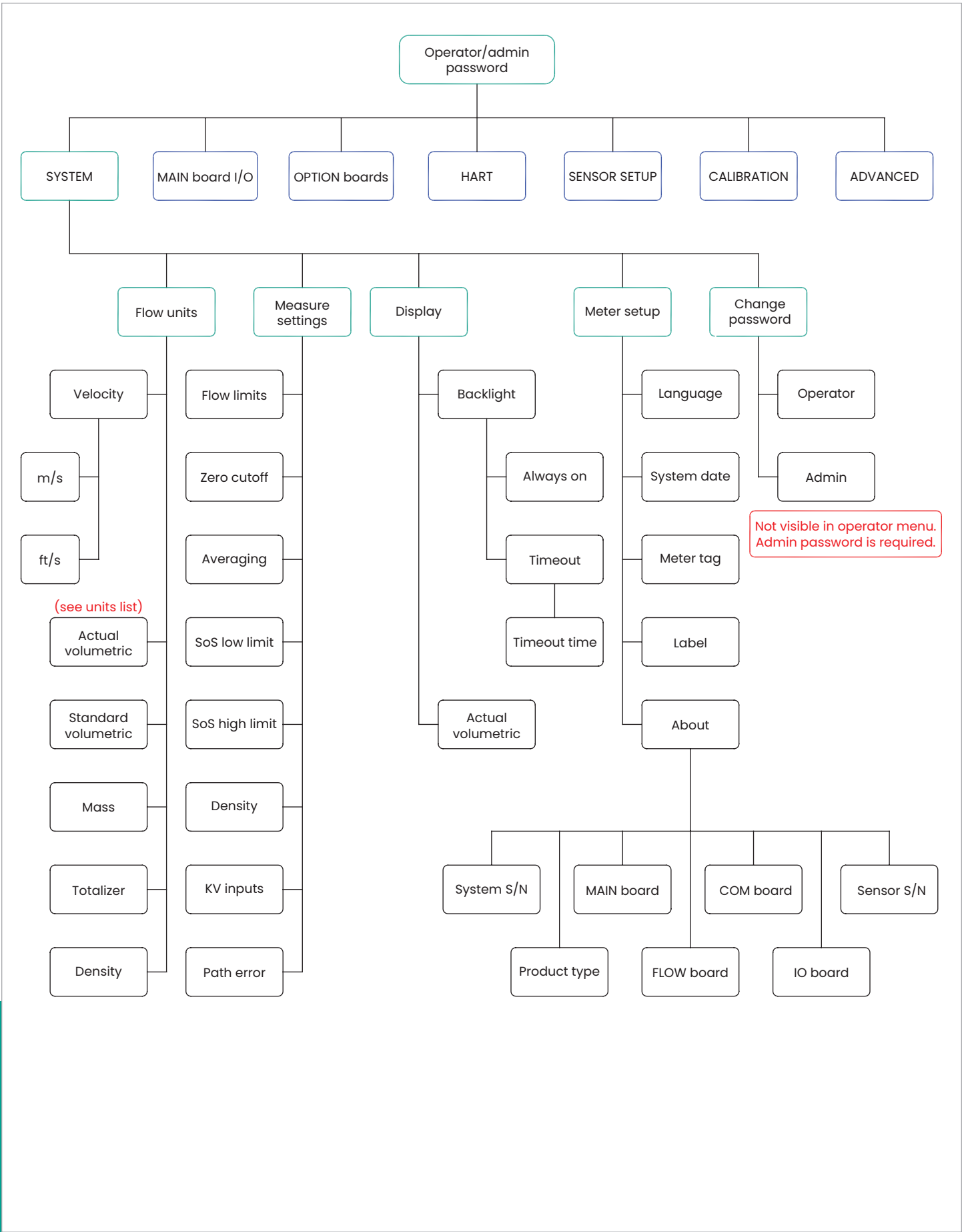

Figure 12: SYSTEM menu map (rev. 10)

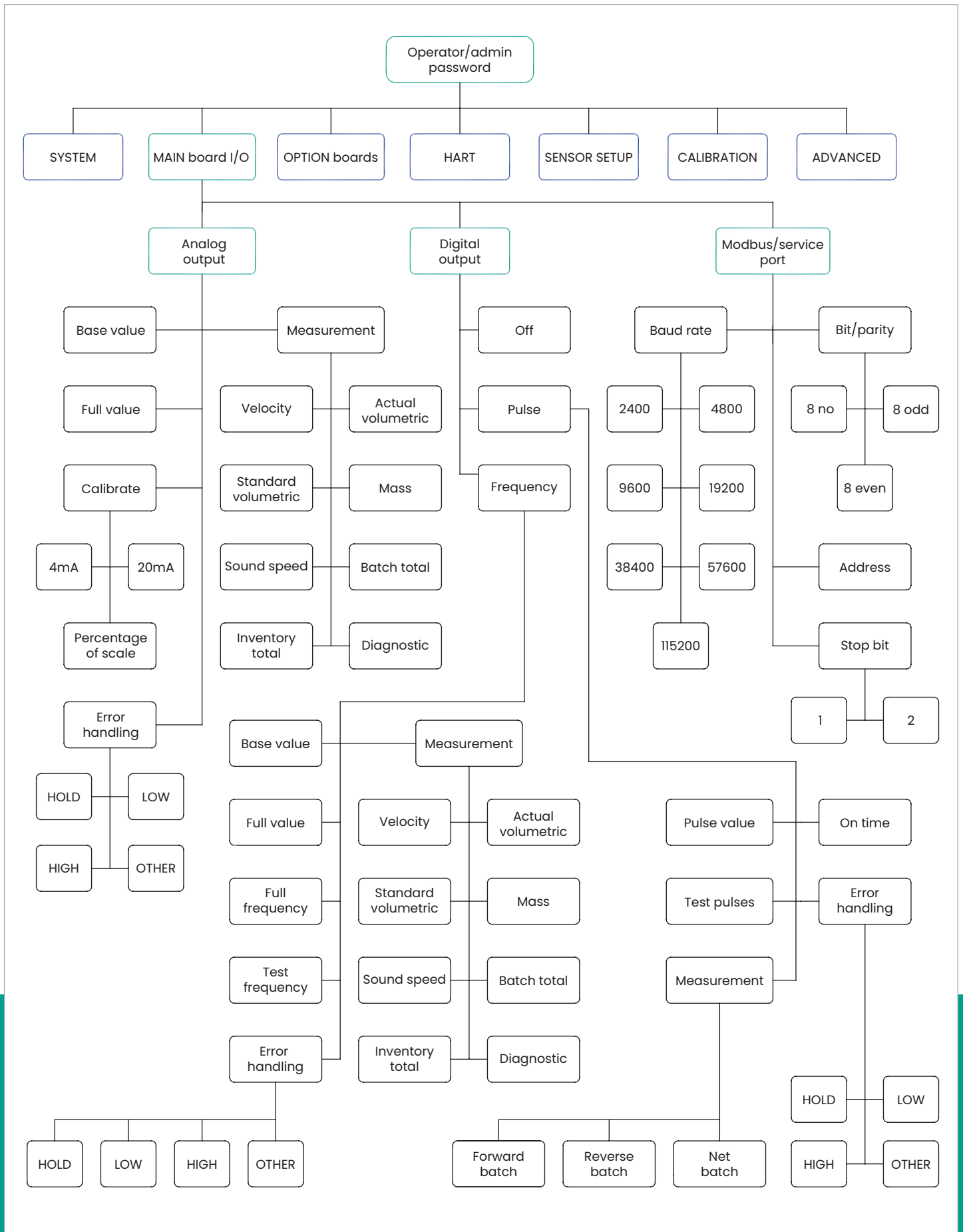

Figure 13: MAIN board I/O menu map (rev. 10)

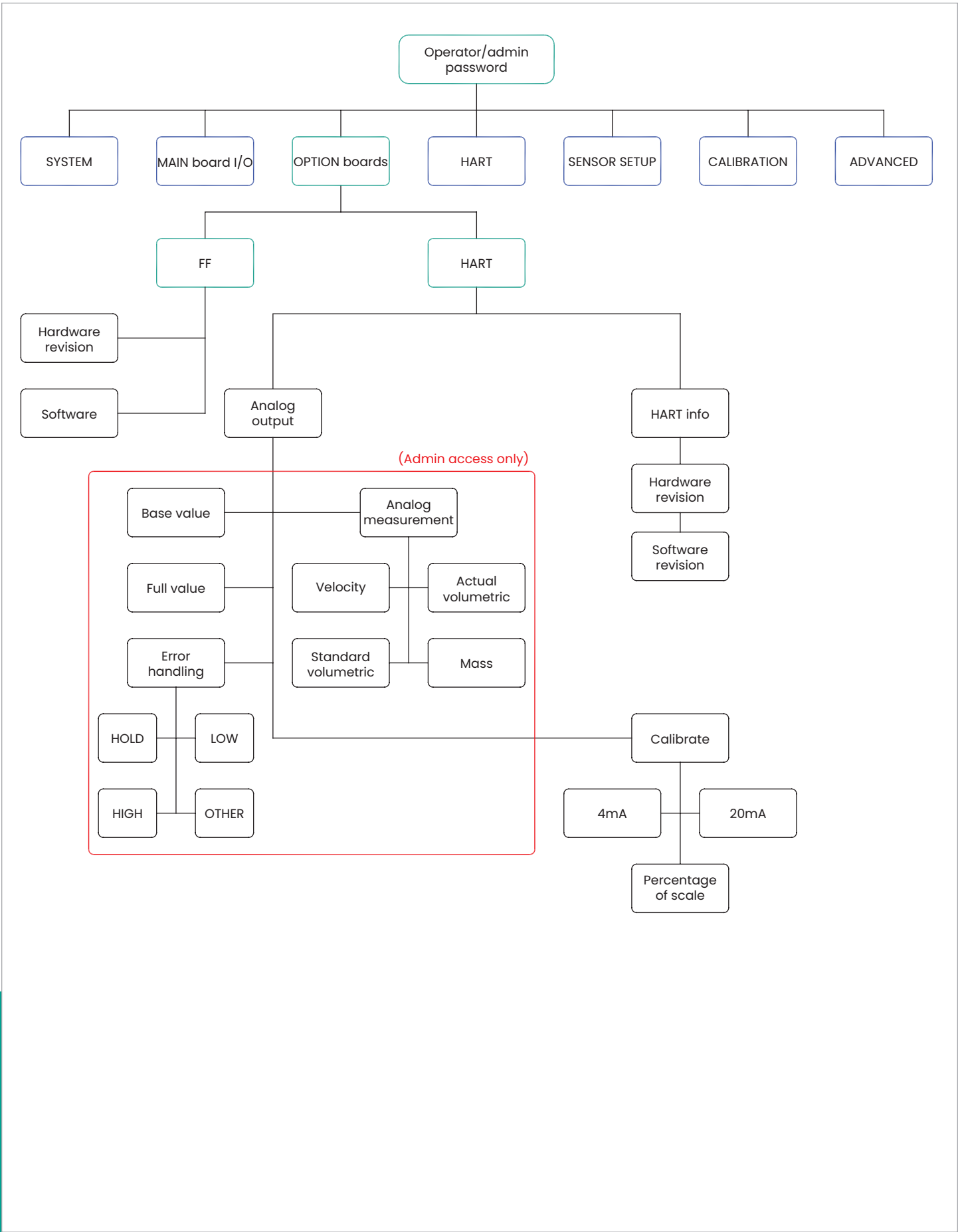

Figure 14: OPTION boards menu map (rev. 10)

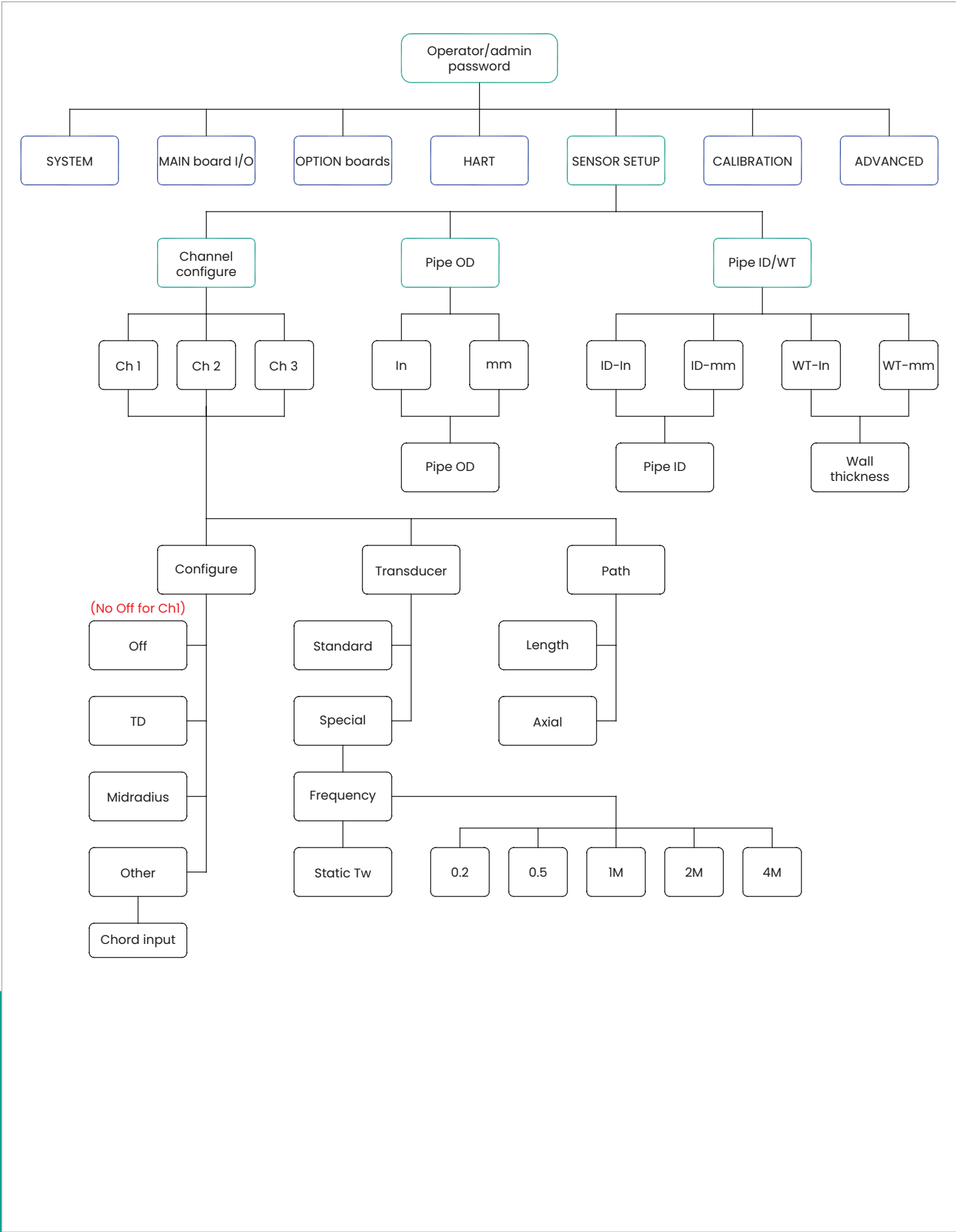

Figure 15: SENSOR SETUP menu map (rev. 10)

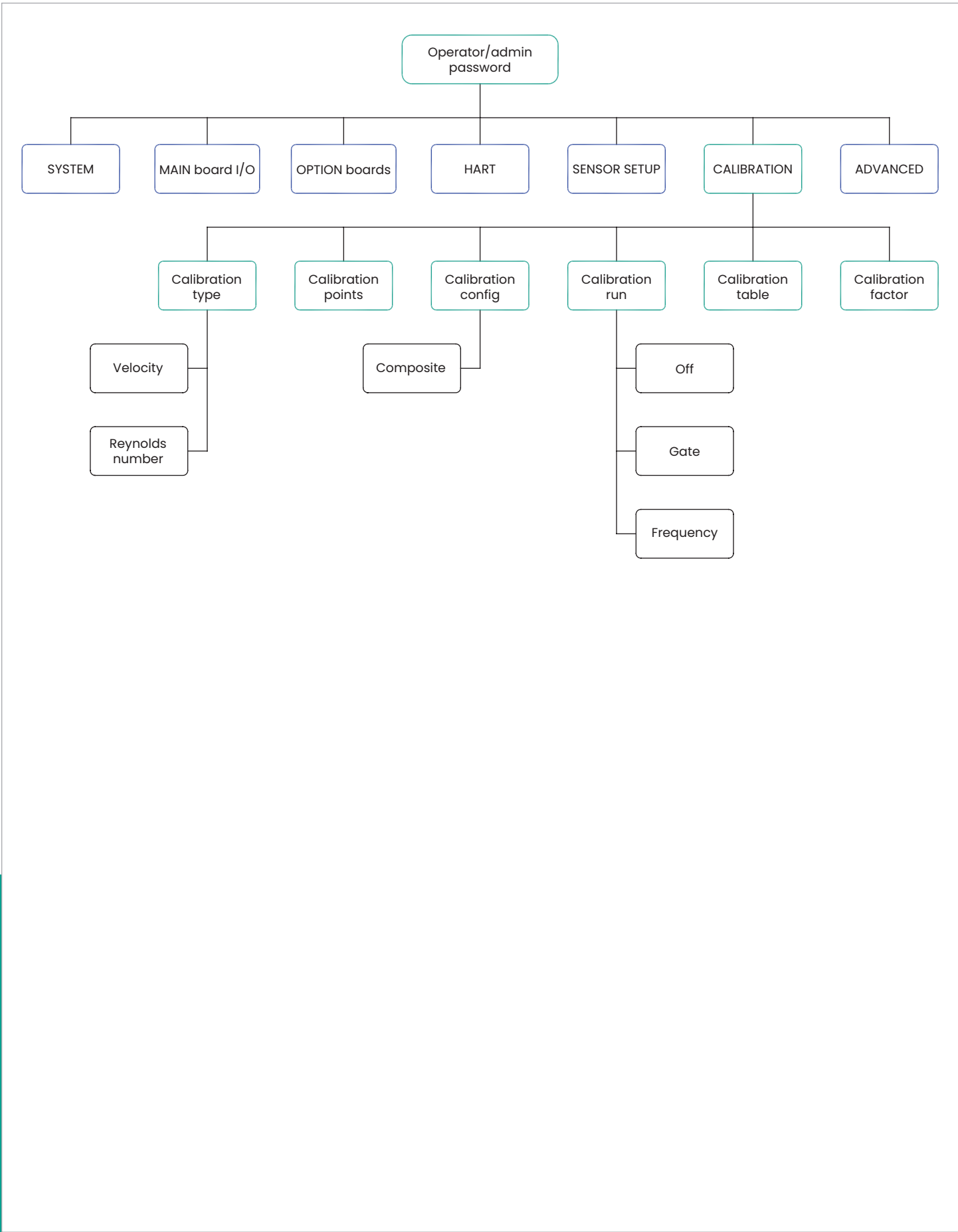

Figure 16: CALIBRATION menu map (rev. 10)

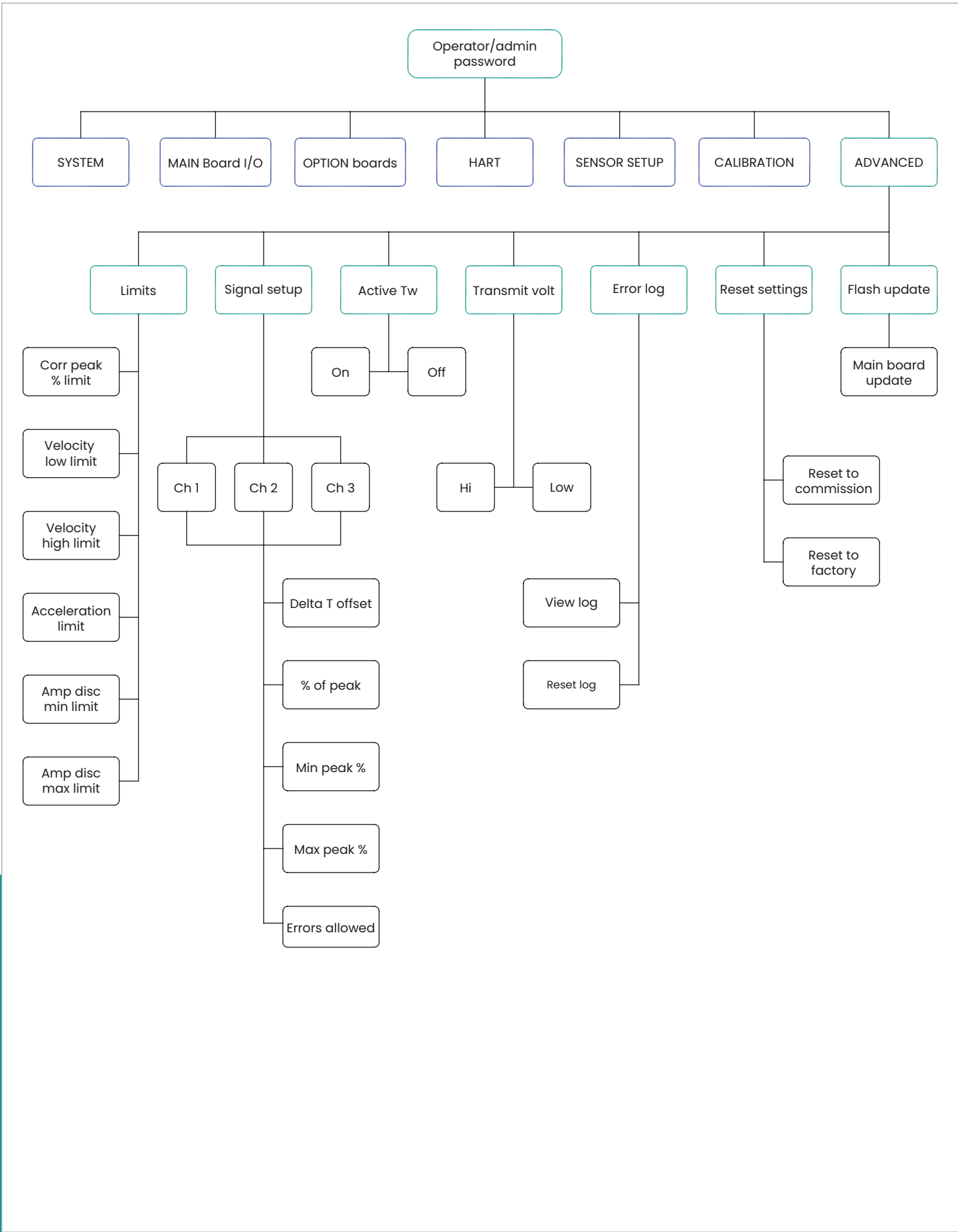

Figure 17: ADVANCED menu map (rev. 10)

Chapter 3. Error codes and troubleshooting

3.1 Error display in the user interface

The bottom line of the LCD displays a single, top priority error message during measurement mode. This line, called the error line, includes two parts: error header and error string. The error header indicates the error pattern and error number, while the error string gives a detailed description of the error information

3.1.1 Error header

Table 2: Error header

Error pattern	Error header
Communication error	Cn (n is error number)
Flow error	En (n is error number)
System error	Sn (n is error number)
XMIT error	Xn (n is error number)
OPT error	On (n is error number)

3.1.2 Communication error string

The XMT1000 flow transmitter electronics includes two independent sub-systems. The purpose of the communication error string is to convey to the operator an issue with communication between these two sub-systems.

Table 3: Communication error string

Error header	Error message
C1	Flow PCB comm error

3.1.3 Flow error string

Flow errors are errors detected by the Flow PCB in the course of making a flow measurement. These errors can be caused by disturbances in the fluid, such as excessive particles in the flow stream or extreme temperature gradients. The errors could also be caused by an empty pipe or other such issue with the fluid itself. Flow errors are typically not caused by a malfunction of the flow measurement device, but by an issue with the fluid itself.

Note: For troubleshooting tips, see “*diagnostics*.”

Table 4: Flow error string

Error code	Error message	Description
E1: SNR	The signal to noise ratio is low.	The acoustic signal from the process is very low. This could be due to bubbles, other fluid conditions, an empty pipe, broken cables, transducers, couplant or buffers.
E2: Soundspeed	The measured soundspeed exceeds programmed limits.	The error may be caused by incorrect programming, poor flow conditions or poor transducer orientation. It may also occur if signal quality is poor.
E3: Velocity range	The measured velocity exceeds programmed limits.	This error may be caused by incorrect programming, poor flow conditions and/or excessive turbulence.
E4: Signal quality	The signal quality is lower than the programmed limits.	This means the signal shape, upstream to downstream reciprocity, or signal correlation value has fallen below the correlation peak limit. The cause is usually the same as E6 or E5.
E5: Amplitude	The signal amplitude exceeds the programmed limits.	This error may occur due to high signal attenuation or amplification due to changes in fluid properties, or transducer/buffer/couplant issues.
E6: Cycle skip	A cycle skip is detected while processing the signal for measurement.	This is usually due to poor signal integrity, possibly because of bubbles in the pipeline, sound absorption by very viscous fluids, or cavitation.
E15: Active tw	The active tw measurement is invalid.	A transducer or cable is damaged, or a transducer needs to be re-coupled. This may also be due to incorrect programming, or extreme process temperatures.
E22: Single channel accuracy	One of the measurement channels is in error.	One measurement channel is in error; accuracy of the measurement may be compromised because the meter might be using a sister chord substitution.
E23: Multi channel accuracy	Two or more measurement channels are in error.	Two or more measurement channels are in error; accuracy of the measurement may be compromised because the meter is using a sister chord substitution.
E28: Software fault	There is a software malfunction	This is a software malfunction. Try power cycling the meter. If the error persists after power cycle, contact Panametrics factory.
E29: Velocity warning	The measured velocity exceeds programmed warning limits.	This error may be caused by incorrect programming, poor flow conditions and/or excessive turbulence.
E31: Not calibrated	The flow meter has not been calibrated.	The flow meter has not been calibrated and hence is not making measurements.

3.2 Diagnostics

3.2.1 Introduction

This section explains how to troubleshoot the XMT1000 if problems arise with the electronics enclosure, the flowcell, or the transducers. Indications of a possible problem include:

- Display of an error message on the LCD display screen, Vitality PC software, or HART.
- Erratic flow readings
- Readings of doubtful accuracy (i.e., readings which are not consistent with readings from another flow measuring device connected to the same process).

If any of the above conditions occurs, proceed with the instructions presented in this section.

3.2.2 Flowcell problems

If preliminary troubleshooting with the *error code messages* and/or the *diagnostic parameters* indicates a possible flowcell problem, proceed with this section. Usually, flowcell problems are either *fluid problems* or *pipe problems*. Read the following sections carefully to determine if the problem is indeed related to the flowcell. If the instructions in this section fail to resolve the problem, contact Panametrics for assistance.

3.2.2a Fluid problems

Most fluid-related problems result from a failure to observe the flow meter system installation instructions. Refer to *chapter 1, installation*, to correct any installation problems.

If the physical installation of the system meets the recommended specifications, it is possible that the fluid itself may be preventing accurate flow rate measurements. The fluid being measured must meet the following requirements:

- **The fluid must be homogeneous, single-phase, relatively clean and flowing steadily.** Although a low level of entrained particles may have little effect on the operation of the XMT1000, excessive amounts of solid or gas particles will absorb or disperse the ultrasound signals. This interference with the ultrasound transmissions through the fluid will cause inaccurate flow rate measurements. In addition, temperature gradients in the fluid flow may result in erratic or inaccurate flow rate readings.
- **The fluid must not cavitate near the flowcell.** Fluids with a high vapor pressure may cavitate near or in the flowcell. This causes problems resulting from gas bubbles in the fluid. Cavitation can usually be controlled through proper installation design.
- **The fluid must not excessively attenuate ultrasound signals.** Some fluids, particularly those that are very viscous, readily absorb ultrasound energy. In such a case, an error code message will appear on the display screen to indicate that the ultrasonic signal strength is insufficient for reliable measurements.

The fluid sound speed must not vary excessively.

The XMT1000 will tolerate relatively large changes in the fluid sound speed, as may be caused by variations in fluid composition and/or temperature. However, such changes must occur slowly. Rapid fluctuations in the fluid sound speed, to a value that is considerably above the limit programmed into the XMT1000, will result in erratic or inaccurate flow rate readings. Refer to *chapter 2, programming*, and make sure that the appropriate sound speed limit is programmed into the meter.

3.2.2b Pipe problems

Pipe-related problems may result either from a failure to observe the installation instructions, as described in *chapter 1, installation*, or from improper programming of the meter (see *chapter 2, programming*, for details).

By far, the most common pipe problems are the following:

- **The collection of material at the transducer location(s).** Accumulated debris at the transducer location(s) will interfere with transmission of the ultrasound signals. As a result, accurate flow rate measurements are not possible. Realignment of the flowcell or transducers often cures such problems, and in some cases, transducers that protrude into the flow stream may be used. Refer to *chapter 1, installation*, for more details on proper installation practices.
- **Inaccurate pipe measurements.** The accuracy of the flow rate measurements is no better than the accuracy of the programmed pipe dimensions. For a flowcell supplied by Panametrics, the correct data will be included in the documentation. For other flowcells, measure the pipe wall thickness and diameter with the same accuracy desired in the flow rate readings. Also, check the pipe for dents, eccentricity, weld deformity, straightness and other factors that may cause inaccurate readings. Refer to *chapter 2, programming*, for instructions on programming the pipe data.

In addition to the actual pipe dimensions, the path length (P) and the axial dimension (L), based on the actual transducer mounting locations, must be accurately programmed into the flow meter. For a Panametrics flowcell, this data will be included with the documentation for the system. If the transducers are mounted onto an existing pipe, these dimensions must be precisely measured.

- **The inside of the pipe or flowcell must be relatively clean.** Excessive build up of scale, rust or debris will interfere with flow measurement. Generally, a thin coating or a solid well-adhered build up on the pipe wall will not cause problems. Loose scale and thick coatings (such as tar or oil) will interfere with ultrasound transmission and may result in incorrect or unreliable measurements.

3.2.3 Transducer/buffer problems

Ultrasonic transducers are rugged, reliable devices. However, they are subject to physical damage from mishandling and chemical attack. The following list of potential problems is grouped according to transducer type. Contact Panametrics if you cannot solve a transducer-related problem.

- **Leaks:** leaks may occur around the transducer buffers and/or the flowcell fittings. Repair such leaks immediately. If the leaking fluid is corrosive, carefully check the transducer and cables for damage, after the leak has been repaired.
- **Corrosion damage:** If the transducer buffer material was not properly chosen for the intended application, they may suffer corrosion damage. The damage usually occurs either at the electrical connector or on the face. If corrosion is suspected, remove the transducer from the flowcell and carefully inspect the buffer electrical connector and the transducer face for roughness and/or pitting. Any transducer damaged in this manner must be replaced. Contact Panametrics for information on transducers in materials suitable for the application.
- **Internal damage:** An ultrasonic transducer consists of a ceramic crystal bonded to the transducer case. The bond between the crystal and the case or the crystal itself may be damaged by extreme mechanical shock and/or temperature extremes. Also, the internal wiring can be corroded or shorted if contaminants enter the transducer housing.
- **Physical damage:** Transducers may be physically damaged by dropping them onto a hard surface or striking them against another object. The transducer connector is the most fragile part and is most subject to damage. Minor damage may be repaired by carefully bending the connector back into shape. If the connector can not be repaired, the transducer must be replaced.

IMPORTANT:

Transducers must be replaced in pairs. Refer to *chapter 2, programming*, to enter the new transducer data into the meter.

If the instructions in this section fail to resolve the problem, contact Panametrics for assistance.

Appendix A. Specifications

A.1 Operation and performance

Fluid types

Acoustically conductive fluids, including most clean liquids, and many liquids with entrained solids or gas bubbles. Maximum void fraction depends on transducer, interrogation carrier frequency, path length and pipe configuration.

Transducer types

All liquid wetted transducers

Pipe sizes

Standard: 1 in. to 76 in. (25 mm to 1930 mm)

Optional: >76 in. (1930 mm) consult factory

Data logging

Storage standard on meter, up to 10,000 flow data points with up to 26 parameters per data point (requires Vitality™ software)

Measurement parameters

Volumetric flow, mass flow, flow velocity and totalized flow

Flow accuracy (velocity)

Up to $\pm 0.3\%$ of reading (achievable when supplied with a complete flow meter system and process calibration). Accuracy depends on pipe size, installation and number of measurement paths.

Note: The accuracy statement assumes measurement of a single phase homogeneous liquid with a fully developed symmetrical flow profile passing through the meter. Applications with piping arrangements that create an asymmetrical flow profile may require extended piping straight runs and/or flow conditioning for the meter to perform to this specification.

Repeatability

$\pm 0.1\%$ to 0.3% of reading

Range (bidirectional)

-40 to 40 ft/s (-12.2 to 12.2 m/s)

Meter turndown

400:1

Optional pc software

Vitality™ PC software for added functionality

A.2 Electronics

Enclosure

Standard: Epoxy-coated aluminum weatherproof 4X/IP66 Class I, div 1, groups B, C and D, flameproof II 2 G Ex d IIC T5/T6

Optional: Stainless steel

Dimensions (standard)

Weight: 10 lb (4.5 kg)

Size (h x d): 8.2 in. x 6.6 in. (208 mm x 168 mm)

Paths

1, 2 or 3 paths

Display

128 x 64 mono-color LCD display, configurable for single or dual measurement parameters

Display languages

English

Keypad

Built-in magnetic, six-button keypad, for full functionality operation

Inputs/outputs

Standard: one analog output**, one digital output*, service/modbus (RS485)

Optional: one analog output** with HART

*Digital outputs are programmable as either pulse or frequency outputs

**Analog outputs are NAMUR NE43 compliant

Power supplies

Standard: 100-240 VAC (50/60 Hz)

Optional: 12 to 28 VDC

Power consumption

15 watts maximum

Wiring connection

Conduit entries include 6 x 3/4" NPT and 1 x 1/2" NPT on bottom, consult Panametrics for available adapters

Electronics classifications (pending)

USA/Canada - explosion-proof class I, division 1, groups B, C, and D

ATEX - Flameproof II 2 G Ex d IIC T6 Gb

IECEx - Flameproof Ex d IIC T6 Gb

RoHS compliance (Directive 2011/65/EU)

CE marking (EMC directive 2014/30/EU, LVD 2014/35/EU)

WEEE compliance (Directive 2012/19/EU)

Electronics mounting

Standard: Local mounting (on meter body)

Optional: Remote mounting (recommended for process temperatures exceeding 150°C). The maximum distance is 1000 ft (300 m) using RG-62 coaxial cable or equivalent. If longer distances are required, consult the factory for assistance.

Terminal blocks

Table 5: Standard terminal block (output A)

I/O type	Connection	Specifications
Analog output	Active output	Output current: 0-22 mA Max load: 600 Ω
Pulse, frequency	Active output	Output voltage: 5 VDC Max voltage with light load: 7 VDC
RS485 modbus	RS485 communications	Standard RS485 communications

Operating temperature

-40° to 140°F (-40° to +60°C)

Note: The LCD display is only visible down to -13°F (-25°C).

Storage temperature

-40° to 158°F (-40° to 70°C)

Humidity (operating and storage)

10-90% RH

Appendix B. Modbus communication

B.1 Modbus protocol

In general, the PanaFlow XMT1000 flow meter follows the standard modbus communications protocol defined by the reference MODBUS APPLICATION PROTOCOL SPECIFICATION V1.1b. This specification is available at www.modbus.org on the Internet. With this reference as a guide, an operator could use any modbus master to communicate with the flow meter.

Listed below are two limits of this implementation:

- The PanaFlow XMT1000 supports only four of the standard function codes. These are read Holding registers (0x03), read input registers (0x04), write multiple registers (0x10), and read file record (0x14).

and

- The flow meter needs a 15 msec gap between modbus requests. The prime objective of the flow meter is to measure flow, so the modbus server has a low priority.

B.2 Modbus register map

Table 6: XMT1000 modbus register map - revision 4.19

	Reg # in hex	Access level	Register ID	Description	Units	RO/ RW	Size in bytes	Format
--	-----------------	-----------------	-------------	-------------	-------	-----------	------------------	--------

Health check + identification (input registers)

210	210	NONE		Product type	Unitless	RO	4	INT32
-----	-----	------	--	--------------	----------	----	---	-------

System real RW

400								
-----	--	--	--	--	--	--	--	--

System int RW

500	500	Operator	eUnit_ActVol	Global unit group 1 for actual volumetric	Unitless	RW	4	INT32
	502	Operator	eUnit_day	Global unit group 2 for day	Unitless	RW	4	INT32
	504	Operator	eUnit_Db	Global unit group 3 for dB	Unitless	RW	4	INT32
	506	Operator	eUnit_Dens	Global unit group 4 for density	Unitless	RW	4	INT32
	508	Operator	eUnit_Diam	Global unit group 5 for dimension	Unitless	RW	4	INT32
	50A	Operator	eUnit_Hz	Global unit group 6 for Hz	Unitless	RW	4	INT32
	50C	Operator	eUnit_Kv	Global unit group 7 for viscosity	Unitless	RW	4	INT32

Table 6: XMT1000 modbus register map - revision 4.19

Reg # in hex	Access level	Register ID	Description	Units	RO/RW	Size in bytes	Format
50E	Operator	eUnit_mA	Global unit group 8 for mA	Unitless	RW	4	INT32
510	Operator	eUnit_mass	Global unit group 9 for mass	Unitless	RW	4	INT32
512	Operator	eUnit_MS	Global unit group 10 for milli second	Unitless	RW	4	INT32
514	Operator	eUnit_NS	Global unit group 11 for nano second	Unitless	RW	4	INT32
516	Operator	eUnit_percent	Global unit group 12 for percent	Unitless	RW	4	INT32
518	Operator	eUnit_second	Global unit group 13 for second	Unitless	RW	4	INT32
51A	Operator	eUnit_StdVol	Global unit group 14 for standard volumetric	Unitless	RW	4	INT32
51C	Operator	eUnit_Therm	Global unit group 15 for therm	Unitless	RW	4	INT32
51E	Viewer	eUnit_TotTime	Global unit group 16 for totalizer time	Unitless	RW	4	INT32
520	Operator	eUnit_Totalizer	Global unit group 17 for totalizer	Unitless	RW	4	INT32
522	Operator	eUnit_Unitless	Global unit group 18 for unitless	Unitless	RW	4	INT32
524	Operator	eUnit_US	Global unit group 19 for micro second	Unitless	RW	4	INT32
526	Operator	eUnit_Vel	Global unit group 20 for velocity	Unitless	RW	4	INT32
528	Operator	eUnit_Rey	Global unit group 21 for Reynolds	Unitless	RW	4	INT32
52A	Gen user	eUnit_temp	Global unit group 22 for temperature	Unitless	RW	4	INT32
52C	Gen user	eUnit_pressure	Global unit group 23 for pressure	Unitless	RW	4	INT32

Table 6: XMT1000 modbus register map - revision 4.19

Reg # in hex	Access level	Register ID	Description	Units	RO/RW	Size in bytes	Format
540	Viewer	eSysReq_Level	System request level	Unitless	RW	4	INT32
542	Viewer	eSysReq_password	System request password	Unitless	RW	4	INT32
544	Viewer	eSysReq_command	System request command	Unitless	RW	4	INT32
546	Factory	eInventory_command	Inventory request command	Unitless	RW	4	INT32
580	Operator	ePCModbus_Baud rate	PC MODBUS baud rate	Unitless	RW	4	INT32
582	Operator	ePCModbus_Parity	PC MODBUS parity	Unitless	RW	4	INT32
584	Operator	ePCModbus_Stop	PC MODBUS stop bits	Unitless	RW	4	INT32
586	Operator	ePCModbus_Address	PC MODBUS meter addr	Unitless	RW	4	INT32
588	Operator	ePCModbus_Bits	PC MODBUS bits per character	Unitless	RW	4	INT32
58A	Operator	ePCModbus_Termination	PC MODBUS termination	Unitless	RW	4	INT32
5C0	Operator	eSystem_TagShort	Meter tag	Unitless	RW	16	CHAR * 16
5C8	Operator	eSystem_TagLong	Long tag	Unitless	RW	32	CHAR * 32
5D8	Factory	eSystem_optType	IO option board type	Unitless	RW	4	INT32
5DA	Factory	eSystem_MCU_serial_number	MCU serial number	Unitless	RW	4	INT32
5DC	Factory	eSystem_MCU_Hardware_Version	MCU hardware version	Unitless	RW	4	INT32
5DE	Factory	eSystem_COM_Hardware_Version	COM board hardware version	Unitless	RW	4	INT32
5E0	Factory	eSystem_OPT_Hardware_Version	IO option hardware version	Unitless	RW	4	INT32
5E2	Factory	eSystem_comType	COM option board type	Unitless	RW	4	INT32
5E4	Factory	eCh_1_Path configuration_E	Ch 1 path configuration	Unitless	RW	4	INT32

Table 6: XMT1000 modbus register map - revision 4.19

	Reg # in hex	Access level	Register ID	Description	Units	RO/RW	Size in bytes	Format
	5E6	Factory	eCh_2_Path configuration_E	Ch 2 path configuration	Unitless	RW	4	INT32
	5E8	Factory	eCh_3_Path configuration_E	Ch 3 path configuration	Unitless	RW	4	INT32

System real RO

600	600	N/A	eInventory_FwdTotal	Inventory fwd totals	17	RO	4	(IEEE 32 bit)
	602	N/A	eInventory_RevTotal	Inventory rev totals	17	RO	4	(IEEE 32 bit)
	604	N/A	eInventory_NetTotal	Inventory net totals	17	RO	4	(IEEE 32 bit)
	606	N/A	eInventory_TotalTime	Inventory totals time	2	RO	4	(IEEE 32 bit)

System int RO

700	700	N/A	eSystem_Idmax	NetworkID_max	Unitless	RO	4	INT32
	702	N/A	eSystem_IdMin	NetworkID_min	Unitless	RO	4	INT32
	704	N/A	eSystem_User password	General user password	Unitless	RO	4	INT32
	706	N/A	eSystem_Admin password	Admin user password	Unitless	RO	4	INT32
	708	N/A	eSystem_MCU_Bootloader_version	MCU bootloader version	Unitless	RO	4	INT32
	70A	N/A	eSystem_MCU_Software_Version	MCU software version	Unitless	RO	4	INT32
	70C	N/A	eSystem_COM_Software_Version	COM option software version	Unitless	RO	4	INT32
	70E	N/A	eSystem_OPT_Software_Version	IO option software version	Unitless	RO	4	INT32
	710	N/A	Reserved	Reserved	Unitless	RO	4	INT32
	712	N/A	eSystem_MCU_Flash_CRC	MCU flash CRC	Unitless	RO	4	INT32
740	740	N/A	eSystem_ErrMaster	Master error	Unitless	RO	4	INT32
	742	N/A	eSystem_MCU_Err	MCU error	Unitless	RO	4	INT32
	744	N/A	eSystem_OPT_Err	Option board error	Unitless	RO	4	INT32
	746	N/A	eSystem_MCU_Startup_Err	MCU startup error	Unitless	RO	4	INT32

Table 6: XMT1000 modbus register map - revision 4.19

Reg # in hex	Access level	Register ID	Description	Units	RO/RW	Size in bytes	Format
748	N/A	eSystem_OPT_Startup_Err	Option startup error	Unitless	RO	4	INT32
74A	N/A	eSystem_comm_Err	Comm error	Unitless	RO	4	INT32
74C	N/A	eSystem_comm_TryNum	Comm try times	Unitless	RO	4	INT32
74E	N/A	eSystem_comm_FailNum	Comm fail times	Unitless	RO	4	INT32
750	N/A	eSystem_comm_wrongNum	Comm data wrong times	Unitless	RO	4	INT32
752	N/A	eSystem_Cmd_State	System command state	Unitless	RO	4	INT32

System real RO

--	--	--	--	--	--	--	--

Display real RW

800							
-----	--	--	--	--	--	--	--

Display int RW

900	900	Operator	eDisplay_Language	Display language	Unitless	RW	4	INT32
	902	Viewer	eDisplay_Var1_value	Display variable_1 register address	Unitless	RW	4	INT32
	904	Viewer	eDisplay_Var1_Unit	Display variable_1 unit code address	Unitless	RW	4	INT32
	906	Viewer	eDisplay_Var2_value	Display variable_2 register address	Unitless	RW	4	INT32
	908	Viewer	eDisplay_Var2_Unit	Display variable_2 unit code address	Unitless	RW	4	INT32
	90A	Viewer	eDisplay_Tot1_Value	Display totalizer_1 register address	Unitless	RW	4	INT32
	90C	Viewer	eDisplay_Tot1_Unit	Display totalizer_1 unit code address	Unitless	RW	4	INT32
	90E	Viewer	eDisplay_Tot2_Value	Display totalizer_2 register address	Unitless	RW	4	INT32
	910	Viewer	eDisplay_Tot2_Unit	Display totalizer_2 unit code address	Unitless	RW	4	INT32

Table 6: XMT1000 modbus register map - revision 4.19

Reg # in hex	Access level	Register ID	Description	Units	RO/RW	Size in bytes	Format
912	Viewer	eDisplay_Graph_Value	Display graph_1 register address	Unitless	RW	4	INT32
914	Viewer	eDisplay_Graph_Unit	Display graph_1 unit code address	Unitless	RW	4	INT32
916	Operator	eDisplay_Select_Vel	Select the velocity	Unitless	RW	4	INT32
918	Operator	eDisplay_Select_ActVol	Select the actual volumetric	Unitless	RW	4	INT32
91A	Operator	eDisplay_Select_StdVol	Select the standardized volumetric	Unitless	RW	4	INT32
91C	Operator	eDisplay_Select_mass	Select mass	Unitless	RW	4	INT32
91E	Operator	eDisplay_Select_Tot	Select totalizer	Unitless	RW	4	INT32
920	Operator	eDisplay_Select_Dens	Select density	Unitless	RW	4	INT32
922	Viewer	eDisplay_Select_Decimal_IST	Select 1st display decimal	Unitless	RW	4	INT32
924	Viewer	eDisplay_Type	Type of DISPLAY	Unitless	RW	4	INT32
926	Operator	eDisplay_Timeout	TimeOut for DISPLAY	13	RW	4	INT32
928	Operator	eDisplay_BackLight	BackLight control	Unitless	RW	4	INT32
92A	Viewer	eDisplay_menuLock	Lock menu	Unitless	RW	4	INT32
92C	Operator	eDisplay_Unit Type_Vel	Unit type for velocity	Unitless	RW	4	INT32
92E	Operator	eDisplay_Unit Type_ActVol	Unit type for actual volumetric	Unitless	RW	4	INT32
930	Operator	eDisplay_Unit Type_StdVol	Unit type for standard volumetric	Unitless	RW	4	INT32
932	Operator	eDisplay_Unit Type_mass	Unit type for mass	Unitless	RW	4	INT32
934	Operator	eDisplay_Unit Type_Totalizer	Unit type for totalizer	Unitless	RW	4	INT32
936	Operator	eDisplay_Unit Type_TTAvol	Unit type for actual volumetric of totalizer	Unitless	RW	4	INT33
938	Operator	eDisplay_Unit Type_TTSvol	Unit type for standard volumetric of totalizer	Unitless	RW	4	INT34

Table 6: XMT1000 modbus register map - revision 4.19

	Reg # in hex	Access level	Register ID	Description	Units	RO/RW	Size in bytes	Format
	93A	Operator	eDisplay_Unit Type_TTMass	Unit type for mass of totalizer	Unitless	RW	4	INT35
	93C	Operator	eDisplay_Unit Type_Dens	Unit type for density	Unitless	RW	4	INT32
	93E	Operator	eDisplay_contrast	Contrast for DISPLAY	Unitless	RW	4	INT32
	940	Viewer	eDisplay_Select_Decimal_2ND	Select 2nd display decimal	Unitless	RW	4	INT32

Display real RO

A00								
-----	--	--	--	--	--	--	--	--

Display int RO

B00	B00	N/A	eDisplay_Timeout_max	Maximum timeout for DISPLAY	13	RO	4	INT32
	B02	N/A	eDisplay_Timeout_Min	Minimum timeout for DISPLAY	13	RO	4	INT32
	B04	N/A	eDisplay_contrast_max	Maximum contrast for DISPLAY	Unitless	RO	4	INT32
	B06	N/A	eDisplay_contrast_Min	Minimum contrast for DISPLAY	Unitless	RO	4	INT32

Log real RW

C00								
-----	--	--	--	--	--	--	--	--

Log int RW

D00	D00	Operator	eLog_control	Log control / status	Unitless	RW	4	INT32
	D02	Operator	eLog_interval	Log interval	13	RW	4	INT32
	D04	Operator	eLog_Time	Logging time	13	RW	4	INT32
	D06	Operator	eLog_numMonitor	Number of variables to log	Unitless	RW	4	INT32
D40	D40	Operator	eLog_VariableValue	Variable address array	Unitless	RW	(4 * 25)	INT32
D80	D80	Operator	eLog_VariableUnit	Variable unit code array	Unitless	RW	(4 * 25)	INT32

Table 6: XMT1000 modbus register map - revision 4.19

Reg # in hex	Access level	Register ID	Description	Units	RO/RW	Size in bytes	Format
--------------	--------------	-------------	-------------	-------	-------	---------------	--------

Log real RO

E00							
-----	--	--	--	--	--	--	--

Log int RO

F00	F00	N/A	eLog_NumRecord	Number of records	Unitless	RO	4	INT32
-----	-----	-----	----------------	-------------------	----------	----	---	-------

MAIN Aout real RW

1000	1000	Operator	eAout1_ErrValue	Analog out 1 error handling value	8	RW	4	(IEEE 32 bit)
	1002	Operator	eAout1_ZeroValue	Analog out 1 zero	8	RW	4	(IEEE 32 bit)
	1004	Operator	eAout1_spanValue	Analog out 1 span	8	RW	4	(IEEE 32 bit)
	1006	Operator	eAout1_TestValue	Analog out 1 test value (percent of span)	12	RW	4	(IEEE 32 bit)
	1008	Operator	eAout1_BaseValue	Analog out 1 base value	1, 9, 14, 17, 20	RW	4	(IEEE 32 bit)
	100A	Operator	eAout1_FullValue	Analog out 1 full value	1, 9, 14, 17, 20	RW	4	(IEEE 32 bit)

HART Aout real RW

1010	1010	Operator	eAout2_ErrValue	Analog out 2 error handling value	8	RW	4	(IEEE 32 bit)
	1012	Operator	eAout2_ZeroValue	Analog out 2 zero	8	RW	4	(IEEE 32 bit)
	1014	Operator	eAout2_spanValue	Analog out 2 span	8	RW	4	(IEEE 32 bit)
	1016	Operator	eAout2_TestValue	Analog out 2 test value (percent of span)	12	RW	4	(IEEE 32 bit)
	1018	Operator	eAout2_BaseValue	Analog out 2 base value	1, 9, 14, 17, 20	RW	4	(IEEE 32 bit)
	101A	Operator	eAout2_FullValue	Analog out 2 full value	1, 9, 14, 17, 20	RW	4	(IEEE 32 bit)

Table 6: XMT1000 modbus register map - revision 4.19

Reg # in hex	Access level	Register ID	Description	Units	RO/RW	Size in bytes	Format
IO Aout1 real RW							
1020	Operator	eAout3_ErrValue	Analog out 3 error handling value	8	RW	4	(IEEE 32 bit)
1022	Operator	eAout3_ZeroValue	Analog out 3 zero	8	RW	4	(IEEE 32 bit)
1024	Operator	eAout3_spanValue	Analog out 3 span	8	RW	4	(IEEE 32 bit)
1026	Operator	eAout3_TestValue	Analog out 3 test value (percent of span)	12	RW	4	(IEEE 32 bit)
1028	Operator	eAout3_BaseValue	Analog out 3 base value	1, 9, 14, 17, 20	RW	4	(IEEE 32 bit)
102A	Operator	eAout3_FullValue	Analog out 3 full value	1, 9, 14, 17, 20	RW	4	(IEEE 32 bit)
IO Aout2 real RW							
1030	Operator	eAout4_ErrValue	Analog out 4 error handling value	8	RW	4	(IEEE 32 bit)
1032	Operator	eAout4_ZeroValue	Analog out 4 zero	8	RW	4	(IEEE 32 bit)
1034	Operator	eAout4_spanValue	Analog out 4 span	8	RW	4	(IEEE 32 bit)
1036	Operator	eAout4_TestValue	Analog out 4 test value (percent of span)	12	RW	4	(IEEE 32 bit)
1038	Operator	eAout4_BaseValue	Analog out 4 base value	1, 9, 14, 17, 20	RW	4	(IEEE 32 bit)
103A	Operator	eAout4_FullValue	Analog out 4 full value	1, 9, 14, 17, 20	RW	4	(IEEE 32 bit)
MAIN Aout int RW							
1180	Operator	eAout1_Mode	Analog out 1 operating mode	Unitless	RW	4	INT32
1182	Operator	RESERVED				4	INT32
1184	Operator	eAout1_Adress	Analog out 1 measurement register address	Unitless	RW	4	INT32
1186	Operator	eAout1_Err	Analog out 1 error handling	Unitless	RW	4	INT32
1188	Operator	eAout1_Unit	Analog out 1 unit code	Unitless	RW	4	INT32

Table 6: XMT1000 modbus register map - revision 4.19

	Reg # in hex	Access level	Register ID	Description	Units	RO/ RW	Size in bytes	Format
--	-----------------	-----------------	-------------	-------------	-------	-----------	------------------	--------

HART Aout int RW

1190	1190	Operator	eAout2_Mode	Analog out 2 operating mode	Unitless	RW	4	INT32
	1192	Operator	eAout2_Type	Analog out 2 type	Unitless	RW	4	INT32
	1194	Operator	eAout2_Adress	Analog out 2 measurement register address	Unitless	RW	4	INT32
	1196	Operator	eAout2_Err	Analog out 2 error handling	Unitless	RW	4	INT32
	1198	Operator	eAout2_Unit	Analog out 2 unit code	Unitless	RW	4	INT32

IO Aout1 int RW

11A0	11A0	Operator	eAout3_Mode	Analog out 3 operating mode	Unitless	RW	4	INT32
	11A2	Operator	eAout3_Type	Analog out 3 type	Unitless	RW	4	INT32
	11A4	Operator	eAout3_Adress	Analog out 3 measurement register address	Unitless	RW	4	INT32
	11A6	Operator	eAout3_Err	Analog out 3 error handling	Unitless	RW	4	INT32
	11A8	Operator	eAout3_Unit	Analog out 3 unit code	Unitless	RW	4	INT32

IO Aout2 int RW

11B0	11B0	Operator	eAout4_Mode	Analog out 4 operating mode	Unitless	RW	4	INT32
	11B2	Operator	eAout4_Type	Analog out 4 type	Unitless	RW	4	INT32
	11B4	Operator	eAout4_Adress	Analog out 4 measurement register address	Unitless	RW	4	INT32
	11B6	Operator	eAout4_Err	Analog out 4 error handling	Unitless	RW	4	INT32
	11B8	Operator	eAout4_Unit	Analog out 4 unit code	Unitless	RW	4	INT32

Table 6: XMT1000 modbus register map - revision 4.19

	Reg # in hex	Access level	Register ID	Description	Units	RO/ RW	Size in bytes	Format
MAIN Aout real RO								
	1200							
MAIN Aout int RO								
	1300							
MAIN Aout max real RW								
	1400							
MAIN Aout max int RW								
	1500							
MAIN Aout max real RO								
	1600	N/A	eAout1_ErrValue_max	Maximum analog out 1 error handling value	8	RO	4	(IEEE 32 bit)
	1602	N/A	eAout1_ZeroValue_max	Maximum analog out 1 zero	8	RO	4	(IEEE 32 bit)
	1604	N/A	eAout1_spanValue_max	Maximum analog out 1 span	8	RO	4	(IEEE 32 bit)
	1606	N/A	eAout1_TestValue_max	Maximum analog out 1 test value (percent of span)	12	RO	4	(IEEE 32 bit)
	1608	N/A	eAout1_BaseValue_max	Maximum analog out 1 base value	1, 9, 14, 17, 20	RO	4	(IEEE 32 bit)
	160A	N/A	eAout1_FullValue_max	Maximum analog out 1 full value	1, 9, 14, 17, 20	RO	4	(IEEE 32 bit)
HART Aout max real RO								
	1610	N/A	eAout2_ErrValue_max	Maximum analog out 2 error handling value	8	RO	4	(IEEE 32 bit)
	1612	N/A	eAout2_ZeroValue_max	Maximum analog out 2 zero	8	RO	4	(IEEE 32 bit)
	1614	N/A	eAout2_spanValue_max	Maximum analog out 2 span	8	RO	4	(IEEE 32 bit)

Table 6: XMT1000 modbus register map - revision 4.19

Reg # in hex	Access level	Register ID	Description	Units	RO/RW	Size in bytes	Format
1616	N/A	eAout2_TestValue_max	Maximum analog out 2 test value (percent of span)	12	RO	4	(IEEE 32 bit)
1618	N/A	eAout2_BaseValue_max	Maximum analog out 2 base value	1, 9, 14, 17, 20	RO	4	(IEEE 32 bit)
161A	N/A	eAout2_FullValue_max	Maximum analog out 2 full value	1, 9, 14, 17, 20	RO	4	(IEEE 32 bit)

IO Aout1 max real RO

1620	1620	N/A	eAout3_ErrValue_max	Maximum analog out 3 error handling value	8	RO	4	(IEEE 32 bit)
1622	N/A	eAout3_ZeroValue_max	Maximum analog out 3 zero	8	RO	4	(IEEE 32 bit)	
1624	N/A	eAout3_spanValue_max	Maximum analog out 3 span	8	RO	4	(IEEE 32 bit)	
1626	N/A	eAout3_TestValue_max	Maximum analog out 3 test value (percent of span)	12	RO	4	(IEEE 32 bit)	
1628	N/A	eAout3_BaseValue_max	Maximum analog out 3 base value	1, 9, 14, 17, 20	RO	4	(IEEE 32 bit)	
162A	N/A	eAout3_FullValue_max	Maximum analog out 3 full value	1, 9, 14, 17, 20	RO	4	(IEEE 32 bit)	

IO Aout2 max real RO

1630	1630	N/A	eAout4_ErrValue_Max	Maximum analog out 4 error handling value	8	RO	4	(IEEE 32 bit)
1632	N/A	eAout4_ZeroValue_max	Maximum analog out 4 zero	8	RO	4	(IEEE 32 bit)	
1634	N/A	eAout4_spanValue_max	Maximum analog out 4 span	8	RO	4	(IEEE 32 bit)	
1636	N/A	eAout4_TestValue_max	Maximum analog out 4 test value (percent of span)	12	RO	4	(IEEE 32 bit)	
1638	N/A	eAout4_BaseValue_max	Maximum analog out 4 base value	1, 9, 14, 17, 20	RO	4	(IEEE 32 bit)	
163A	N/A	eAout4_FullValue_max	Maximum analog out 4 full value	1, 9, 14, 17, 20	RO	4	(IEEE 32 bit)	

Table 6: XMT1000 modbus register map - revision 4.19

Reg # in hex	Access level	Register ID	Description	Units	RO/ RW	Size in bytes	Format
Aout2 max int RO							
1700							
Aout2 Min real RW							
1800							
MAIN Aout Min int RW							
1900							
MAIN Aout Min real RO							
1A00	1A00	N/A	eAout1_ErrValue_Min	Minimum analog out 1 error handling value	8	RO	4 (IEEE 32 bit)
	1A02	N/A	eAout1_ZeroValue_Min	Minimum analog out 1 zero	8	RO	4 (IEEE 32 bit)
	1A04	N/A	eAout1_spanValue_Min	Minimum analog out 1 span	8	RO	4 (IEEE 32 bit)
	1A06	N/A	eAout1_TestValue_Min	Minimum analog out 1 test value (percent of span)	12	RO	4 (IEEE 32 bit)
	1A08	N/A	eAout1_BaseValue_Min	Minimum analog out 1 base value	1, 9, 14, 17, 20	RO	4 (IEEE 32 bit)
	1A0A	N/A	eAout1_FullValue_Min	Minimum analog out 1 full value	1, 9, 14, 17, 20	RO	4 (IEEE 32 bit)
HART Aout Min real RO							
1A10	1A10	N/A	eAout2_ErrValue_Min	Minimum analog out 2 error handling value	8	RO	4 (IEEE 32 bit)
	1A12	N/A	eAout2_ZeroValue_Min	Minimum analog out 2 zero	8	RO	4 (IEEE 32 bit)
	1A14	N/A	eAout2_spanValue_Min	Minimum analog out 2 span	8	RO	4 (IEEE 32 bit)
	1A16	N/A	eAout2_TestValue_Min	Minimum analog out 2 test value (percent of span)	12	RO	4 (IEEE 32 bit)
	1A18	N/A	eAout2_BaseValue_Min	Minimum analog out 2 base value	1, 9, 14, 17, 20	RO	4 (IEEE 32 bit)

Table 6: XMT1000 modbus register map - revision 4.19

	Reg # in hex	Access level	Register ID	Description	Units	RO/ RW	Size in bytes	Format
	1A1A	N/A	eAout2_FullValue_Min	Minimum analog out 2 full value	1, 9, 14, 17, 20	RO	4	(IEEE 32 bit)

IO Aout1 Min real RO

1A20	1A20	N/A	eAout3_ErrValue_Min	Minimum analog out 3 error handling value	8	RO	4	(IEEE 32 bit)
	1A22	N/A	eAout3_ZeroValue_Min	Minimum analog out 3 zero	8	RO	4	(IEEE 32 bit)
	1A24	N/A	eAout3_spanValue_Min	Minimum analog out 3 span	8	RO	4	(IEEE 32 bit)
	1A26	N/A	eAout3_TestValue_Min	Minimum analog out 3 test value (percent of span)	12	RO	4	(IEEE 32 bit)
	1A28	N/A	eAout3_BaseValue_Min	Minimum analog out 3 base value	1, 9, 14, 17, 20	RO	4	(IEEE 32 bit)
	1A2A	N/A	eAout3_FullValue_Min	Minimum analog out 3 full value	1, 9, 14, 17, 20	RO	4	(IEEE 32 bit)

IO Aout2 Min real RO

1A30	1A30	N/A	eAout4_ErrValue_Min	Minimum analog out 4 error handling value	8	RO	4	(IEEE 32 bit)
	1A32	N/A	eAout4_ZeroValue_Min	Minimum analog out 4 zero	8	RO	4	(IEEE 32 bit)
	1A34	N/A	eAout4_spanValue_Min	Minimum analog out 4 span	8	RO	4	(IEEE 32 bit)
	1A36	N/A	eAout4_TestValue_Min	Minimum analog out 4 test value (percent of span)	12	RO	4	(IEEE 32 bit)
	1A38	N/A	eAout4_BaseValue_Min	Minimum analog out 4 base value	1, 9, 14, 17, 20	RO	4	(IEEE 32 bit)
	1A3A	N/A	eAout4_FullValue_Min	Minimum analog out 4 full value	1, 9, 14, 17, 20	RO	4	(IEEE 32 bit)

MAIN Aout Min int RO

1B00								
------	--	--	--	--	--	--	--	--

Table 6: XMT1000 modbus register map - revision 4.19

	Reg # in hex	Access level	Register ID	Description	Units	RO/ RW	Size in bytes	Format
MAIN Dout1 real RW								
2000	2000	Operator	eDout1_PulseValue	Output_1 pulse value	17	RW	4	(IEEE 32 bit)
	2002	Operator	eDout1_PulseTime	Output_1 pulse time	10	RW	4	(IEEE 32 bit)
	2004	Operator	eDout1_freqBaseValue	Output_1 frequency base value	1, 9, 14, 17, 20	RW	4	(IEEE 32 bit)
	2006	Operator	eDout1_freqFullValue	Output_1 frequency full value	1, 9, 14, 17, 20	RW	4	(IEEE 32 bit)
	2008	Operator	eDout1_AlarmValue	Output_1 alarm value	1, 9, 14, 17, 20	RW	4	(IEEE 32 bit)
	200A	Operator	eDout1_controlValue	Output_1 control output value	17	RW	4	(IEEE 32 bit)
MAIN Dout1 int RW								
2100	2100	Operator	eDout1_PulseTestValue	Output_1 test pulse value	Unitless	RW	4	INT32
	2102	Operator	eDout1_freqFullfreq	Output_1 frequency full frequency	6	RW	4	INT32
	2104	Operator	eDout1_freqTestValue	Output_1 test frequency value	6	RW	4	INT32
	2106	Operator	eDout1_freqErrValue	Output_1 frequency error handling value	6	RW	4	INT32
2180	2180	Operator	eDout1_Type	Output_1 type	Unitless	RW	4	INT32
	2182	Operator	eDout1_PulseUnit	Output_1 pulse value unit code	Unitless	RW	4	INT32
	2184	Operator	eDout1_PulseErr	Output_1 pulse error handling	Unitless	RW	4	INT32
	2186	Operator	eDout1_freqAddress	Output_1 frequency measurement register address	Unitless	RW	4	INT32
	2188	Operator	eDout1_freqErr	Output_1 frequency error handling	Unitless	RW	4	INT32

Table 6: XMT1000 modbus register map - revision 4.19

Reg # in hex	Access level	Register ID	Description	Units	RO/RW	Size in bytes	Format
218A	Operator	eDout1_freqUnit	Output_1 frequency Unit code	Unitless	RW	4	INT32
218C	Operator	eDout1_AlarmState	Output_1 alarm State	Unitless	RW	4	INT32
218E	Operator	eDout1_AlarmType	Output_1 alarm type	Unitless	RW	4	INT32
2190	Operator	eDout1_AlarmAddress	Output_1 alarm measurement register address	Unitless	RW	4	INT32
2192	Operator	eDout1_AlarmUnit	Output_1 alarm unit code	Unitless	RW	4	INT32
2194	Operator	eDout1_Alarm TestValue	Output_1 test alarm	Unitless	RW	4	INT32
2196	Operator	eDout1_controlState	Output_1 control output state	Unitless	RW	4	INT32
2198	Operator	eDout1_controlType	Output_1 control output type	Unitless	RW	4	INT32
219A	Operator	eDout1_controlAddress	Output_1 control output measurement register address	Unitless	RW	4	INT32
219C	Operator	eDout1_controlUnit	Output_1 control output unit code	Unitless	RW	4	INT32
219E	Operator	eDout1_control TestVale	Output_1 test control output	Unitless	RW	4	INT32
21A0	Operator	eDout1_reserved	Output_1 reserved	Unitless	RW	4	INT32
21A2	Operator	eDout1_TestMode	Output_1 test mode	Unitless	RW	4	INT32
21A4	Operator	eDout1_PulseAddress	Output_1 pulse measurement register address	Unitless	RW	4	INT32
21A6	Operator	eDout1_Pulsecount	Output_1 pulse output count	Unitless	RW	4	INT33

Table 6: XMT1000 modbus register map - revision 4.19

	Reg # in hex	Access level	Register ID	Description	Units	RO/ RW	Size in bytes	Format
MAIN Dout1 real RO								
2200								
MAIN Dout1 int RO								
2300								
TBD Dout2 real RW								
2400	2400	Operator	eDout2_PulseValue	Output_2 pulse value	17	RW	4	(IEEE 32 bit)
	2402	Operator	eDout2_PulseTime	Output_2 pulse time	10	RW	4	(IEEE 32 bit)
	2404	Operator	eDout2_freqBaseValue	Output_2 frequency base value	1, 9, 14, 17,			
20	RW	4	(IEEE 32 bit)					
	2406	Operator	eDout2_freqFullValue	Output_2 frequency full value	1, 9, 14, 17,			
20	RW	4	(IEEE 32 bit)					
	2408	Operator	eDout2_AlarmValue	Output_2 alarm value	1, 9, 14, 17,			
20	RW	4	(IEEE 32 bit)					
	240A	Operator	eDout2_controlValue	Output_2 control output value	17	RW	4	(IEEE 32 bit)
TBD Dout2 int RW								
2500	2500	Operator	eDout2_PulseTestValue	Output_2 test pulse value	Unitless	RW	4	INT32
	2502	Operator	eDout2_freqFullfreq	Output_2 frequency full frequency	6	RW	4	INT32
	2504	Operator	eDout2_freqTestValue	Output_2 test frequency value	6	RW	4	INT32
	2506	Operator	eDout2_freqErrValue	Output_2 frequency error handling value	6	RW	4	INT32

Table 6: XMT1000 modbus register map - revision 4.19

Reg # in hex	Access level	Register ID	Description	Units	RO/RW	Size in bytes	Format
2580	Operator	eDout2_Type	Output_2 type	Unitless	RW	4	INT32
2582	Operator	eDout2_PulseUnit	Output_2 pulse value unit code	Unitless	RW	4	INT32
2584	Operator	eDout2_PulseErr	Output_2 pulse error handling	Unitless	RW	4	INT32
2586	Operator	eDout2_freqAddress	Output_2 frequency measurement register address	Unitless	RW	4	INT32
2588	Operator	eDout2_freqErr	Output_2 frequency error handling	Unitless	RW	4	INT32
258A	Operator	eDout2_freqUnit code	Output_2 frequency unit	Unitless	RW	4	INT32
258C	Operator	eDout2_AlarmState	Output_2 alarm state	Unitless	RW	4	INT32
258E	Operator	eDout2_AlarmType	Output_2 alarm type	Unitless	RW	4	INT32
2590	Operator	eDout2_AlarmAddress	Output_2 alarm measurement register address	Unitless	RW	4	INT32
2592	Operator	eDout2_AlarmUnit	Output_2 alarm unit code	Unitless	RW	4	INT32
2594	Operator	eDout2_AlarmTest	Output_2 test alarm	Unitless	RW	4	INT32
2596	Operator	eDout2_controlState	Output_2 control output state	Unitless	RW	4	INT32
2598	Operator	eDout2_controlType	Output_2 control output type	Unitless	RW	4	INT32
259A	Operator	eDout2_controlAddress	Output_2 control output measurement register address	Unitless	RW	4	INT32
259C	Operator	eDout2_controlUnit	Output_2 control output unit code	Unitless	RW	4	INT32
259E	Operator	eDout2_controlTest	Output_2 test control output	Unitless	RW	4	INT32

Table 6: XMT1000 modbus register map - revision 4.19

	Reg # in hex	Access level	Register ID	Description	Units	RO/RW	Size in bytes	Format
	25A0	Operator	eDout2_PhaseShift	Output_2 phase shift	Unitless	RW	4	INT32
	25A2	Operator	eDout2_TestMode	Output_2 test mode	Unitless	RW	4	INT32
	25A4	Operator	eDout2_PulseAddress	Output_2 pulse measurement register address	Unitless	RW	4	INT32
	25A6	Operator	eDout2_Pulsecount	Output_2 pulse output count	Unitless	RW	4	INT33

TBD Dout2 real RO

2600								
------	--	--	--	--	--	--	--	--

TBD Dout2 int RO

2700								
------	--	--	--	--	--	--	--	--

Dout max real RW

2800								
------	--	--	--	--	--	--	--	--

Dout max int RW

2900								
------	--	--	--	--	--	--	--	--

MAIN Dout max real RO

2A00	2A00	N/A	eDout1_PulseValue_max	Maximum output_1 pulse value	17	RO	4	(IEEE 32 bit)
	2A02	N/A	eDout1_PulseTime_max	Maximum output_1 pulse time	10	RO	4	(IEEE 32 bit)
	2A04	N/A	eDout1_freqBaseValue_max	Maximum output_1 frequency base value	1, 9, 14, 17, 20	RO	4	(IEEE 32 bit)
	2A06	N/A	eDout1_freqFullValue_max	Maximum output_1 frequency full value	1, 9, 14, 17, 20	RO	4	(IEEE 32 bit)
	2A08	N/A	eDout1_AlarmValue_max	Maximum output_1 alarm value	1, 9, 14, 17, 20	RO	4	(IEEE 32 bit)
	2A0A	N/A	eDout1_controlValue_max	Maximum output_1 control output value	17	RO	4	(IEEE 32 bit)

Table 6: XMT1000 modbus register map - revision 4.19

	Reg # in hex	Access level	Register ID	Description	Units	RO/ RW	Size in bytes	Format
--	-----------------	-----------------	-------------	-------------	-------	-----------	------------------	--------

TBD Dout max real RO

2A80	2A80	N/A	eDout2_PulseValue_max	Maximum output_2 pulse value	17	RO	4	(IEEE 32 bit)
	2A82	N/A	eDout2_PulseTime_max	Maximum output_2 pulse time	10	RO	4	(IEEE 32 bit)
	2A84	N/A	eDout2_freqBaseValue_max	Maximum output_2 frequency base value	1, 9, 14, 17, 20	RO	4	(IEEE 32 bit)
	2A86	N/A	eDout2_freqFullValue_max	Maximum output_2 frequency full value	1, 9, 14, 17, 20	RO	4	(IEEE 32 bit)
	2A88	N/A	eDout2_AlarmValue_max	Maximum output_2 alarm value	1, 9, 14, 17, 20	RO	4	(IEEE 32 bit)
	2A8A	N/A	eDout2_control Value_max	Maximum output_2 control output value	17	RO	4	(IEEE 32 bit)

MAIN Dout max int RO

2B00	2B00	N/A	eDout1_Pulse TestValue_max	Maximum output_1 test pulse value	Unitless	RO	4	INT32
	2B02	N/A	eDout1_freq Fullfreq_max	Maximum output_1 frequency full frequency	6	RO	4	INT32
	2B04	N/A	eDout1_freq TestValue_max	Maximum output_1 test frequency value	6	RO	4	INT32
	2B06	N/A	eDout1_freq ErrValue_max	Maximum output_1 frequency error handling value	6	RO	4	INT32

TBD Dout max int RO

2B80	2B80	N/A	eDout2_Pulse TestValue_max	Maximum output_2 test pulse value	Unitless	RO	4	INT32
	2B82	N/A	eDout2_freq FullFreq_max	Maximum output_2 frequency full frequency	6	RO	4	INT32
	2B84	N/A	eDout2_freq TestValue_max	Maximum output_2 test frequency value	6	RO	4	INT32
	2B86	N/A	eDout2_freq ErrValue_max	Maximum output_2 frequency error handling value	6	RO	4	INT32

Table 6: XMT1000 modbus register map - revision 4.19

	Reg # in hex	Access level	Register ID	Description	Units	RO/RW	Size in bytes	Format
--	--------------	--------------	-------------	-------------	-------	-------	---------------	--------

Dout Min real RW

2C00								
------	--	--	--	--	--	--	--	--

Dout Min int RW

2D00								
------	--	--	--	--	--	--	--	--

MAIN Dout Min real RO

2E00	2E00	N/A	eDout1_Pulse Value_Min	Minimum output_1 pulse value	17	RO	4	(IEEE 32 bit)
	2E02	N/A	eDout1_Pulse Time_Min	Minimum output_1 pulse time	10	RO	4	(IEEE 32 bit)
	2E04	N/A	eDout1_freq BaseValue_Min	Minimum output_1 frequency base value	1, 9, 14, 17, 20	RO	4	(IEEE 32 bit)
	2E06	N/A	eDout1_freq FullValue_Min	Minimum output_1 frequency full value	1, 9, 14, 17, 20	RO	4	(IEEE 32 bit)
	2E08	N/A	eDout1_Alarm Value_Min	Minimum output_1 alarm value	1, 9, 14, 17, 20	RO	4	(IEEE 32 bit)
	2E0A	N/A	eDout1_controlValue_Min	Minimum output_1 control output value	17	RO	4	(IEEE 32 bit)

TBD Dout Min real RO

2E80	2E80	N/A	eDout2_Pulse Value_Min	Minimum output_2 pulse value	17	RO	4	(IEEE 32 bit)
	2E82	N/A	eDout2_Pulse Time_Min	Minimum output_2 pulse time	10	RO	4	(IEEE 32 bit)
	2E84	N/A	eDout2_freq BaseValue_Min	Minimum output_2 frequency base value	1, 9, 14, 17, 20	RO	4	(IEEE 32 bit)
	2E86	N/A	eDout2_freq FullValue_Min	Minimum output_2 frequency full value	1, 9, 14, 17, 20	RO	4	(IEEE 32 bit)
	2E88	N/A	eDout2_Alarm Value_Min	Minimum output_2 alarm value	1, 9, 14, 17, 20	RO	4	(IEEE 32 bit)
	2E8A	N/A	eDout2_controlValue_Min	Minimum output_2 control output value	17	RO	4	(IEEE 32 bit)

Table 6: XMT1000 modbus register map - revision 4.19

	Reg # in hex	Access level	Register ID	Description	Units	RO/ RW	Size in bytes	Format
--	-----------------	-----------------	-------------	-------------	-------	-----------	------------------	--------

MAIN Dout Min int RO

2F00	2F00	N/A	eDout1_Pulse TestValue_Min	Minimum output_1 test pulse value	Unitless	RO	4	INT32
	2F02	N/A	eDout1_freq Fullfreq_Min	Minimum output_1 frequency full frequency	6	RO	4	INT32
	2F04	N/A	eDout1_freq TestValue_Min	Minimum output_1 test frequency value	6	RO	4	INT32
	2F06	N/A	eDout1_freq ErrValue_Min	Minimum output_1 frequency error handling value	6	RO	4	INT32

TBD Dout Min int RO

2F80	2F80	N/A	eDout2_Pulse TestValue_Min	Minimum output_2 test pulse value	Unitless	RO	4	INT32
	2F82	N/A	eDout2_freq FullFreq_Min	Minimum output_2 frequency full frequency	6	RO	4	INT32
	2F84	N/A	eDout2_freq TestValue_Min	Minimum output_2 test frequency value	6	RO	4	INT32
	2F86	N/A	eDout2_Freq ErrValue_Min	Minimum output_2 frequency error handling value	6	RO	4	INT32

Hart real RW

3000								
------	--	--	--	--	--	--	--	--

Hart int RW

3100	3100	Viewer	eHart_Unit	Hart unit code	Unitless	RW	4	INT32
------	------	--------	------------	----------------	----------	----	---	-------

Hart real RO

3200								
------	--	--	--	--	--	--	--	--

Hart int RO

3300								
------	--	--	--	--	--	--	--	--

FF real RW

3400								
------	--	--	--	--	--	--	--	--

Table 6: XMT1000 modbus register map - revision 4.19

	Reg # in hex	Access level	Register ID	Description	Units	RO/ RW	Size in bytes	Format
FF int RW								
	3500	Viewer	eFFUnitType_Density_E	Fieldbus unit type register for density	Unitless	RW	4	INT32
	3502	Viewer	eFFUnitType_Volumetric_E	Fieldbus unit type register for volumetric	Unitless	RW	4	INT32
	3504	Viewer	eFFUnitType_MassFlow_E	Fieldbus unit type register for massflow	Unitless	RW	4	INT32
	3508	Viewer	eFFUnitType_Totals_E	Fieldbus unit type register for totals	Unitless	RW	4	INT32
FF real RO								
	3600	N/A	eFFDensity_reading	Measurement for fieldbus for density	Fieldbus unit type register for density	RO	4	(IEEE 32 bit)
	3602	N/A	eFFVolumetric_reading	Measurement for fieldbus for volumetric	Fieldbus unit type register for volumetric	RO	4	(IEEE 32 bit)
	3604	N/A	eFFMassFlow_reading	Measurement for fieldbus for massflow	Fieldbus unit type register for massflow	RO	4	(IEEE 32 bit)
	3606	N/A	eFFVelocity_reading	Measurement for fieldbus for velocity	Fieldbus unit type register for velocity	RO	4	(IEEE 32 bit)
	3608	N/A	eFFTotals_reading	Measurement for fieldbus for totals	Fieldbus unit type register for totals	RO	4	(IEEE 32 bit)
FF int RO								
	3700							
	Files							
	3000	N/A	eFile_Monitor	Flow monitoring log	Unitless	RO	2	
	3001	N/A	eFile_Error	Error log	Unitless	RO	2	

Appendix C. HART communication

C.1 Wiring the XMT1000 to the HART communicator

When connecting a HART communicator to the wiring terminals on the PanaFlow XMT1000 electronics terminal board, the circuit must be terminated in an appropriate resistive load, as shown in *figure 16* below. The HART communicator is connected in parallel with that load.

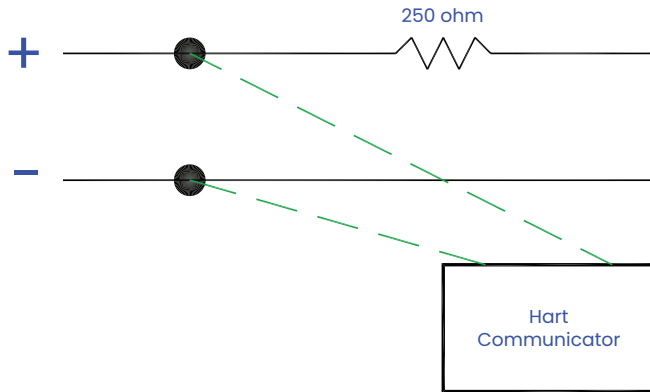

Figure 16: Wiring diagram for HART communication

C.2 HART write mode switch

The XMT1000 HART circuit includes a slide switch which can be used to disable write access to the instrument via HART. This slide switch (pictured in *figure 17* below) is designed to lock out HART configuration access for those customers who require this extra level of security. With the write mode switch pushed to the right, the HART circuit is in write enabled mode.

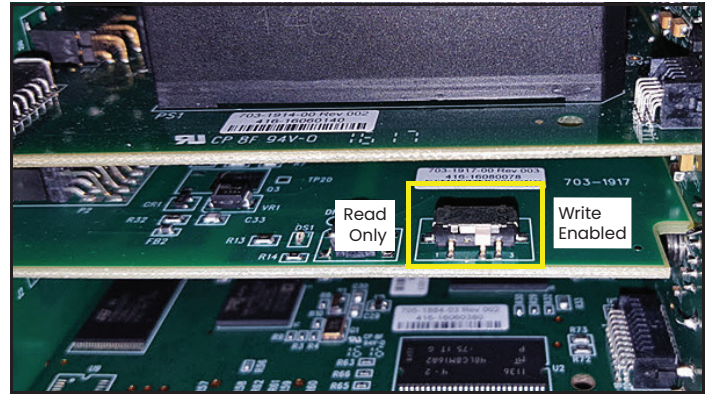

Figure 17: HART Circuit write mode switch

Note: The following sections of this Appendix provide menu maps for programming the XMT1000 via HART communication. To make programming changes through HART, the HART circuit must be set to write Enabled mode. Attempting to write to a device in read only mode will cause the device to indicate that the meter is in write-protect mode.

C.3 HART menu maps

For reference while programming the XMT1000, see the following HART menu maps:

- “HART output menu map”
- “HART review menu map”

C.3.1 HART output menu map

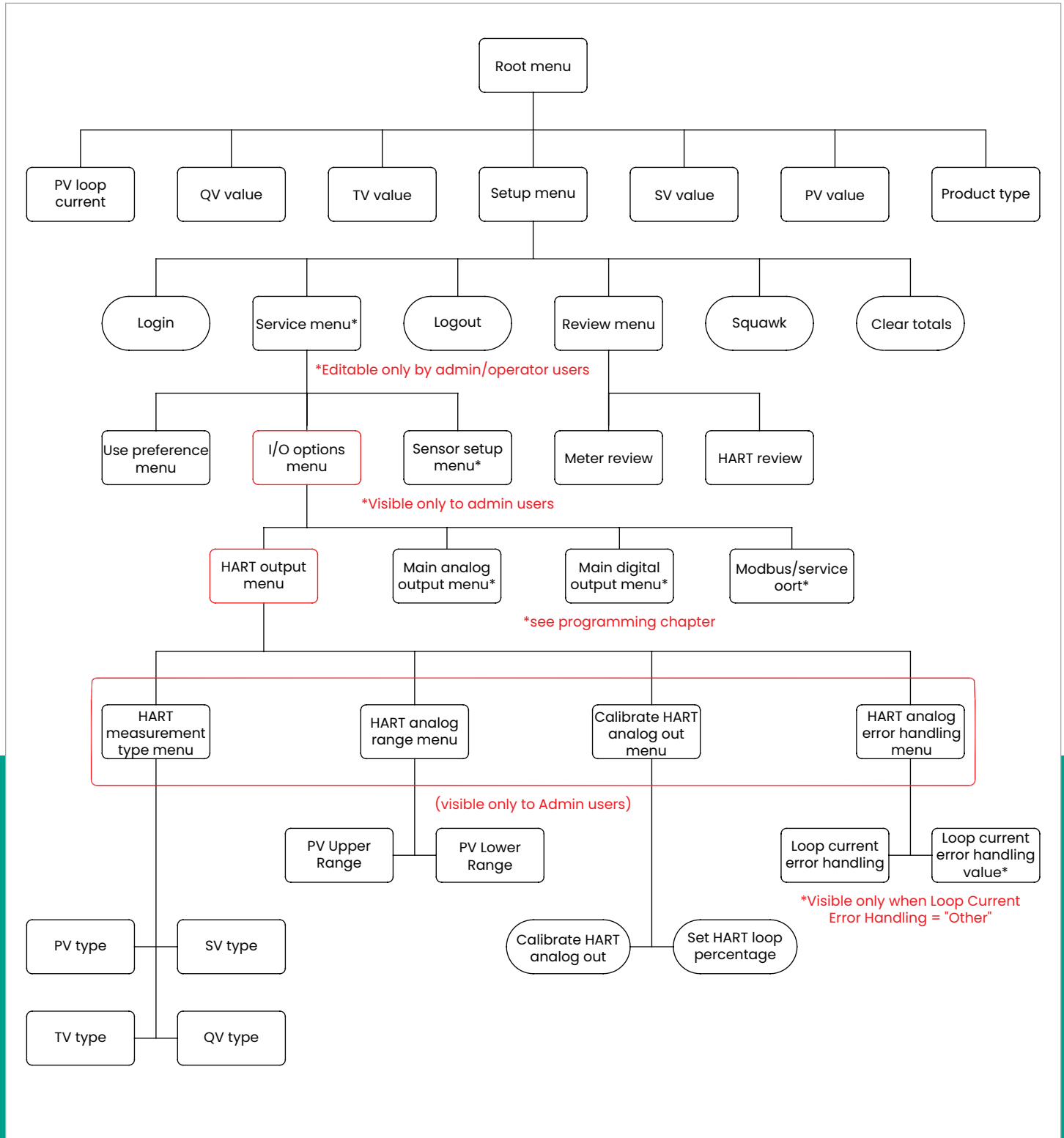

Figure 18: HART output menu map

C.3.2 HART review menu map

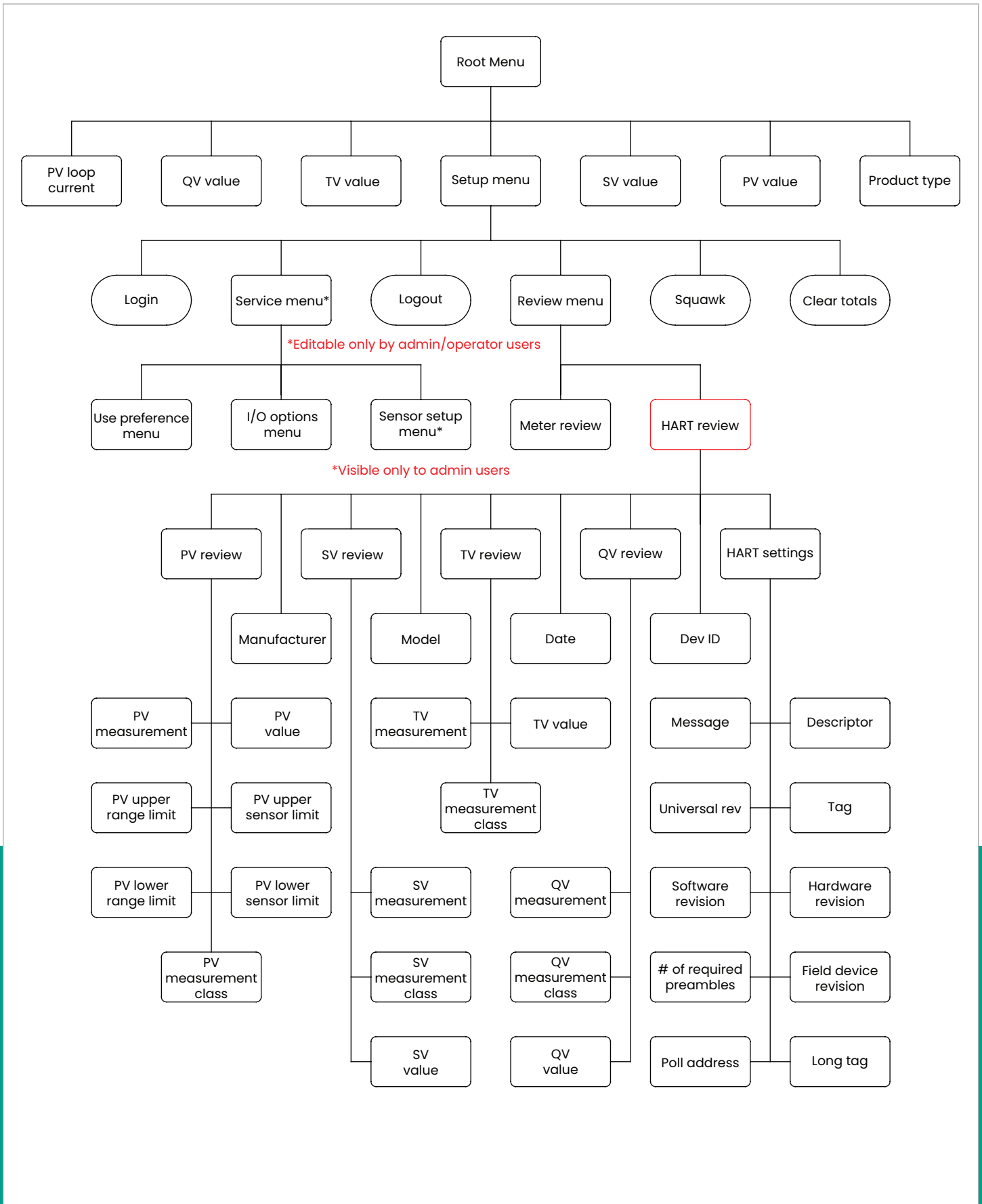

Figure 19: HART review menu map

Appendix D. Foundation fieldbus communication

D.1 Introduction

Fieldbus is a bi-directional digital communication protocol for field devices, which offers an advancement in technologies for process control systems and is widely employed by numerous field devices.

The **XMT1000 FF** option is designed to the specification standardized by the fieldbus foundation, and provides interoperability with devices produced by other manufacturers. The fieldbus option **PCB** comes with software consisting of five AI function blocks and one PID function block.

Note: For more general information on other features, engineering, design, construction work, startup and maintenance of fieldbus, refer to *fieldbus technical Information (TI 38K3A01-01E)*.

D.2 Installation

D.2.1 Network configuration

The following instruments are required for use with fieldbus devices:

- **Power supply:** fieldbus requires a dedicated power supply. It is recommended that current capacity be well over the total value of the maximum current consumed by all devices (including the host). Conventional DC current cannot be used as is.
- **Terminators:** fieldbus requires two terminators. Refer to the supplier for details of terminators that are attached to the host.
- **Field devices:** connect the field devices necessary for instrumentation. XMT1000 has passed the interoperability test conducted by the fieldbus foundation. To properly start fieldbus, use devices that satisfy the requirements of the above test.
- **Host:** used for accessing field devices. A dedicated host (such as DCS) is used for an instrumentation line while dedicated communication tools are used for experimental purposes.

D.2.2 Polarity

The XMT1000 foundation fieldbus terminals are marked (+) and (-). However, the design is polarity insensitive. This means the XMT1000 will communicate even if the connections are reversed.

D.2.3 Connection

Connect the fieldbus wires to P1 on the terminal PCB (see *figure 20* below). Panametrics recommends using the top right rear port on the enclosure.

IMPORTANT:

Please make sure to follow all local installation guidelines.

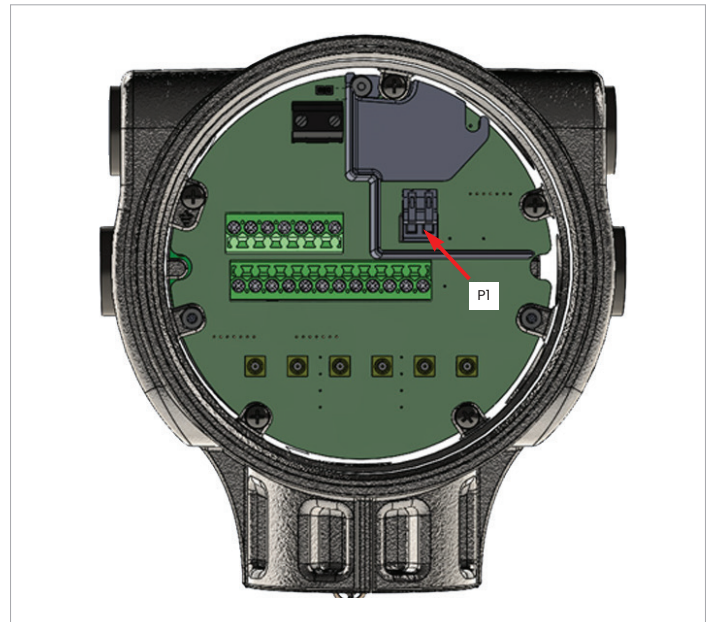

Figure 20: FF connection to XMT1000

D.2.4 FISCO (fieldbus intrinsically safe concept)

The XMT1000 fieldbus is certified as a FISCO connection for both entity and FISCO parameters:

- **FISCO parameters**

V_{max} or $U_i = 17.5$ V
 I_{max} or $L_i = 380$ mA
 $C_i = 0$
 $L_i = 10$ μ H
 $P_i = 5.32$ W

- **Entity parameters**

V_{max} or $U_i = 24$
 $V I_{max}$ or $L_i = 250$ mA
 $C_i = 0$
 $L_i = 10$ μ H
 $P_i = 5.32$ W

Note: The XMT1000 FISCO control drawing is Panametrics drawing #752-584. Please consult the factory for a copy of the drawing.



Attention!

The FISCO cover must be installed to comply with FISCO guidelines.

IMPORTANT:

The FISCO cover on the XMT1000 terminal PCB is required to provide a barrier between IS and non-IS connections. This cover must be installed if the fieldbus application is FISCO.

The FISCO cover should come installed from the factory, as shown in *figure 21* below. The fieldbus cables should be installed through the XMT1000 upper right port for direct entry into the FISCO zone on the terminal PCB.

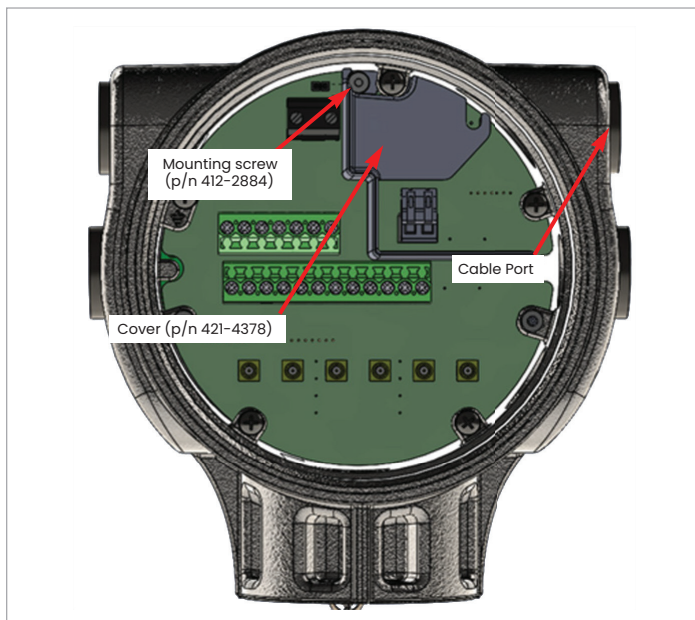

Figure 21: Installed FISCO cover and mounting Screw

D.2.5 DD file

The DD file can be found on the foundation fieldbus website www.fieldbus.org under **Panametrics** as manufacturer and **XMT1000** as model. It may also be found on the DCS vendor website if available.

D.2.6 Default node address

The *default node address* for each XMT1000 flow meter from the factory is **17** (see *figure 22* below). This should be changed during commissioning.

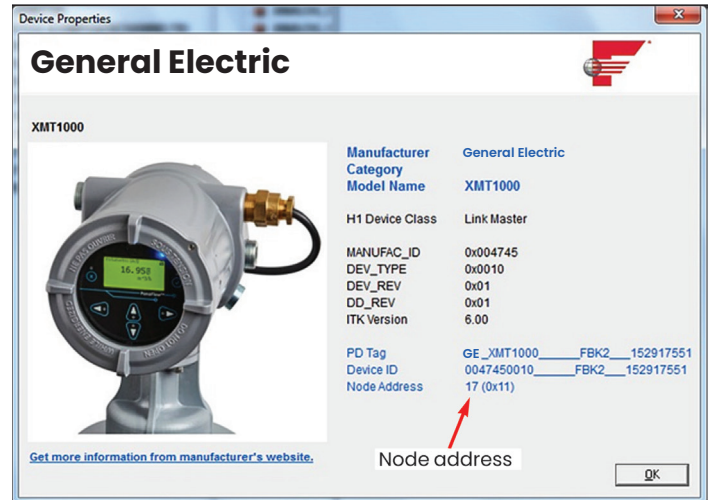

Figure 22: XMT1000 device properties

D.3 Specifications

D.3.1 General

Manufacturer name:	Panametrics
Manufacturer ID (hex):	004745
Model:	XMT1000
Device type:	0010
FF device revision:	For latest, see fieldbus foundation website
FISCO compliant:	Yes
Hazardous location certs:	See drawing 752-584
ITK revision:	6.2
Protocol:	H1
Protocol baud (bps):	31.25k
DD and CFF files:	For latest, see fieldbus foundation website
Meter programmable through FF:	Yes

D.3.2 Physical

Polarity sensitive (yes/no):	No
Quiescent current draw (mA):	26
Working voltage:	9-32 VDC

D.3.3 Communication

Stack manufacturer:	Softing AG
Backup LAS capable:	Yes*
Total number of VCRs:	24
Fixed VCRs for configuration:	1

*LAS means Link Active Scheduler. It can schedule a network if the main LAS fails.

D.3.4 User Layer

FB application manufacturer:	Softing AG
Function blocks:	5-AI(e), 1-PID
Supports block instantiation:	No
Firmware upgrade over fieldbus:	No
Configuration write protect:	HW jumper on PCB

D.3.5 Function blocks

Resource block class type:	Enhanced (field diagnostics)
Transducer blocks:	XMIT, COMPOSIT CH, CH 1, CH 2, CH 3
Transducer block class type:	Custom
Function blocks:	AI (5), PID
FB execution time (ms):	20, 40
Function block class type:	Standard

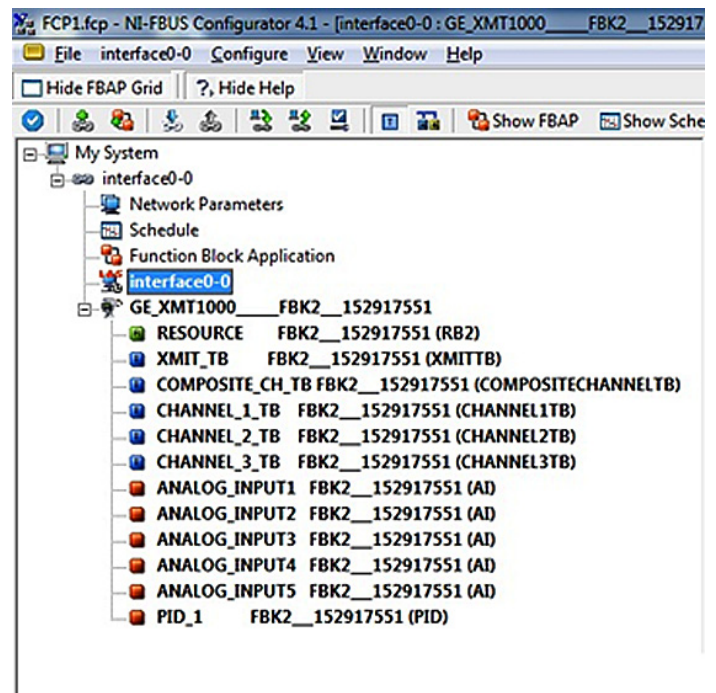

Figure 23: XMT1000 FF blocks

D.4 Resource block

The *resource block* provides common information about the XMT1000 foundation fieldbus implementation. The user can find FF revision numbers, set passwords and configure the NAMUR NE107 bit map.

D.4.1 FF revision

Figure 24 below shows the foundation fieldbus **SW** and **HW** versions in the XMT1000 *resource block*, and includes an *FF revision* for both.

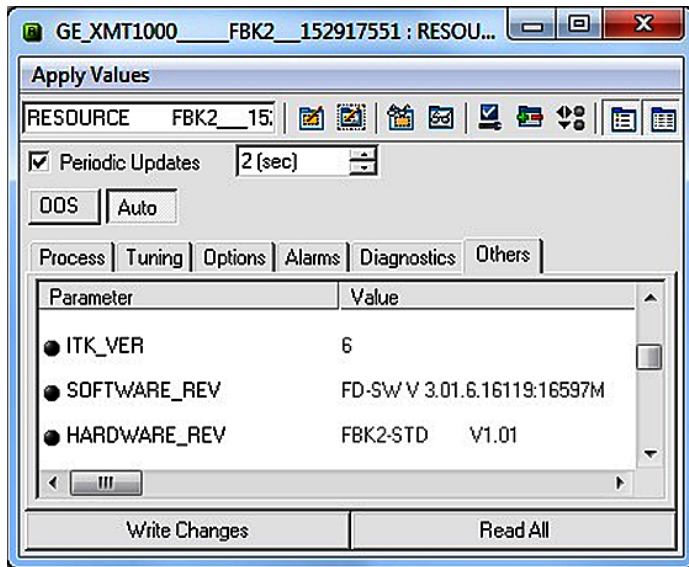

Figure 24: FF revision in XMT1000 resource block

D.4.2 Password

A password must be entered to change XMT1000 system parameters. This can be done using foundation fieldbus. There are different levels of security for different passwords (**admin** or **operator**). Please see the standard manual for more detail on password levels. Figure 25 below shows the password fields in the XMT1000 resource block.

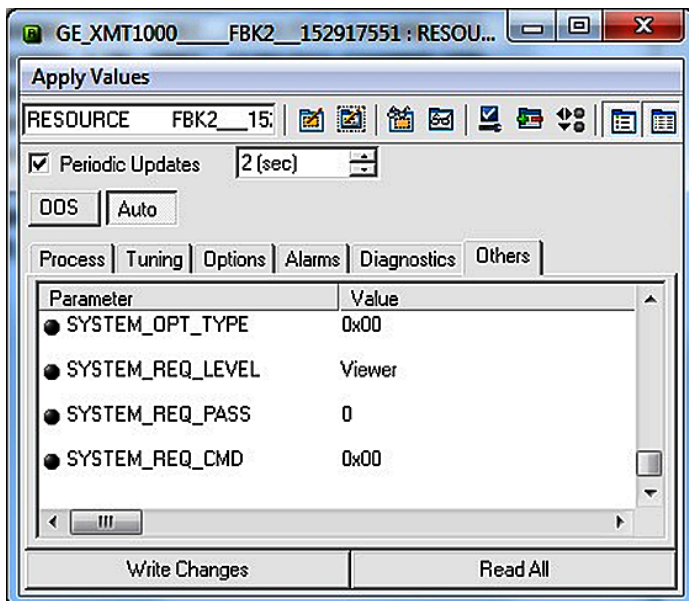

Figure 25: Password fields in XMT1000 resource block



Attention!

Before entering a password, make sure the **XMIT_TB** transducer block is in active mode.

To Enter configuration mode, complete the following steps:

1. Select the **resource block > others** tab.
2. Select **SYSTEM_OPT_TYPE** and set to **option FI**.
3. Select **SYSTEM_REQ_LEVEL** and set to **admin** or **operator**.
4. Enter the **admin** or **operator** password into the **SYSTEM_REQ_PASS** field.
5. Select **cancel** from the **SYSTEM_REQ_CMD** drop down box.
6. Select **login** from the **SYSTEM_REQ_CMD** drop down box.
7. Click on the **write changes** button.
8. Verify that **SI:In config mode** appears on XMT1000 display. You should now be able to edit fields with **admin** privileges.

To *edit* the fields in the transducer blocks, complete the following steps:

1. Select or enter the **new value**.
2. Click on the **write changes** button.
3. Return to the **resource block > others** tab and select **commit** from the **SYSTEM_REQ_CMD** drop down box
4. Click on the **write changes** button.

To *exit* configuration mode, complete the following steps:

1. Select **cancel** from the **SYSTEM_REQ_CMD** drop down box.
2. Click on the **write changes** button.

Note: The XMT1000 will automatically exit configuration mode after 5 minutes of inactivity.

D.4.3 NAMUR NE107

The **NAMUR NE107** recommendation specifies that detailed device-specific diagnostics are summarized as four simple status signals. The diagnostics are set to defaults by Panametrics, but they can be modified to any other level by the user. The four status signals are:

- **Failed:** This category is typically used for hardware or software failures. The meter output is not valid. Consult with the factory for a resolution.
- **Offspec:** This category is typically used for application, installation, or process problems. Consult the troubleshooting section of this appendix or contact Panametrics customer service for assistance.
- **Check:** This category means the output of the device is invalid due to on-going work on the device, such as programming, etc.
- **Maintenance:** This category is typically used to assign parameters that are in good status but which may fall out of specification due to some process condition or wear factor. There are no diagnostics set as default in this category.

The status signals (see *figure 26* below) can either be reported as errors (**ACTIVE**) or masked when the error occurs (**MASK**). There are no default settings for the **MASK** bits.

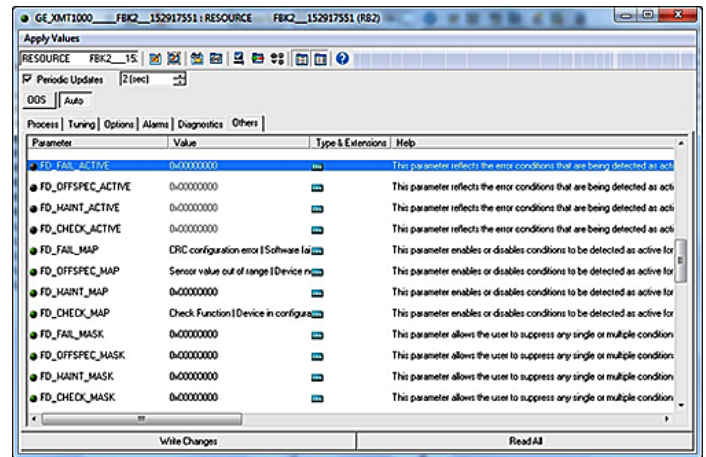

Figure 26: NAMUR NE107 configuration in resource block

The NAMUR NE107 *errors* and their *default categories* in the XMT1000 **resource block** are listed in *table 7* below.

Table 7: NAMUR NE107 errors and XMT1000 default categories

Error	Sub-error description	Default category
CRC configuration error	Persistent parameter CRC fault	Failed
Software failure	Stack overflow failure	Failed
	Sequence or windowed watch dog failure	Failed
	Software fault	Failed
Device initialization failure	Initialization failed	Failed
Hardware failure	ADC Bit test fault	Failed
	VGA test fault	Failed
	Clock frequency fault	Failed
	CPU test fault	Failed
	Invariable flash memory fault	Failed
	Variable memory fault	Failed
	FPGA configuration CRC fault	Failed
	Temperature test fault	Failed
	Driver failure	Failed
	Watch dog failure	Failed
	DSP hardware errors	Failed
	Default ISR (DSP exception)	Failed
	DSP exception	Failed
Modbus communication loss	No Modbus communication	Failed
Sensor value out of range	Velocitywarning	Offspec
Device not calibrated	NotCalibrated	Offspec
Sensor measurement error	SingleChAccuracy	Offspec
	MultiChAccuracy	Offspec
	ActiveTw	Offspec
	CycleSkip	Offspec
	Amplitude	Offspec
	SignalQuality	Offspec
	VelocityRange	Offspec
	SoundSpeed	Offspec
SNR	Offspec	
Device in configuration mode	In configuration mode - indication	Check
Unsupported parameter warning	Unsupported parameter - warning	Check
Invalid parameter range warning	Invalid parameter range - warning	Check
Invalid request warning	Invalid request - warning	Check
Invalid user warning	Invalid User - warning	Check

D.5 XMIT transducer block

The XMIT transducer block contains parameters that can be transmitted onto the fieldbus via the AI block. The user can view real time data and select the units for each of the parameters (see figure 27 below).

The screenshot shows a software window titled "GE_XMT1000__FBK2__152917551 : XMIT_TB" and "FBK2__152917551 (XMITTB)". The window has a menu bar with "Apply Values" and a toolbar. Below the toolbar, there are checkboxes for "Periodic Updates" (checked) and "OOS" (set to "Auto"). A navigation bar includes "Process", "I/O Config", "Alarms", "Diagnostics", "Trends", and "Others". The main area is a table with columns: "Parameter", "Value", "Type & Extensions", and "Help".

Parameter	Value	Type & Extensions	Help
<ul style="list-style-type: none"> [-] DENSITY [-] VALUE [-] STATUS [-] QUALITY [-] SUBSTATUS [-] LIMITS 	1000		The measured value and status available for the Function Block. A numerical quantity entered by a user or calculated by the algorithm.
DENSITY_UNIT	kg/m ³		No help available
<ul style="list-style-type: none"> [-] VOLUMETRIC_FLOW [-] VALUE [-] STATUS [-] QUALITY [-] SUBSTATUS [-] LIMITS 	0.008166		The measured value and status available for the Function Block. A numerical quantity entered by a user or calculated by the algorithm.
VOLUMETRIC_FLOW_UNIT	m ³ /s		No help available
<ul style="list-style-type: none"> [-] MASS_FLOW [-] VALUE [-] STATUS [-] QUALITY [-] SUBSTATUS [-] LIMITS 	8.166		The measured value and status available for the Function Block. A numerical quantity entered by a user or calculated by the algorithm.
MASS_FLOW_UNIT	kg/s		No help available
<ul style="list-style-type: none"> [-] FLOW_VELOCITY [-] VALUE [-] STATUS [-] QUALITY [-] SUBSTATUS [-] LIMITS 	1.28355		The measured value and status available for the Function Block. A numerical quantity entered by a user or calculated by the algorithm.
FLOW_VELOCITY_UNIT	m/s		No help available
<ul style="list-style-type: none"> [-] TOTALS [-] VALUE [-] STATUS [-] QUALITY [-] SUBSTATUS [-] LIMITS 	11.3599		The measured value and status available for the Function Block. A numerical quantity entered by a user or calculated by the algorithm.
TOTALS_UNIT	m ³		No help available

At the bottom of the window, there are two buttons: "Write Changes" and "Read All".

Figure 27: Measurement parameters and Units in XMIT transducer block

D.5.1 Units

The measurement parameters found on the **XMIT transducer block** have several selectable units. *Table 8* below lists the available units for each parameter.

Note: The units can only be changed using an **admin** password. Make sure the selected units agree between the **XMIT transducer block** and the **AI block**.

Table 8: Available parameters and units in XMIT transducer block

Parameter	Units
Density	g/m ³ , kg/L, g/ml, kg/m ³ , lb/in ³ , lb/ft ³ , lb/gal
Volumetric flow (act)	m ³ /s, m ³ /m, m ³ /h, m ³ /d, L/s, L/min, L/h, ML/d, CFS, CFM, CFH, ft ³ /d, gal/s, GPM, gal/h, gal/d, ImpGal/s, ImpGal/min, ImpGal/h, ImpGal/d, bbl/s, bbl/min, bbl/h, bbl/d, kgal/min, kgal/h, kgal/d, kbbbl/min, kbbbl/h, kbbbl/d, ac-ft/m, ac-ft/h, ac-ft/d
Mass flow	kg/s, kg/min, kg/h, kg/d, t/s, t/min, t/h, t/d, lb/s, lb/min, lb/h, lb/d, Ston/s, Ston/min, Ston/h, Ston/d, klb(US)/s, klb(US)/min, klb(US)/h, klb(US)/d
Velocity	m/s, ft/s
Totals	m ³ , L, ft ³ , gallon, bbl, Mgal, Mft ³ , ImpGal, Mbbbl, MI, Mm ³ , ac-ft, ac-in, Sm ³ , SL, SCF
Temperature	K, C, F, R
Pressure	kg-m ² , Pa, Mpa, kPa, bar, mbar, torr, atm, psia, psig

D.6 Composite transducer block

The **composite transducer block** provides the *measurement values* and *programmable parameters* that are common to all three paths. Figure 28 below shows the **composite transducer block** and table 9 lists the *measurements* and *parameters* that are available.

Note: The R/W designation means that the parameter is writable in FF using an **admin** password.

The screenshot shows a software window titled "GE_XMT1000__FBK2__152917551 : COMPOSITE_CH_TB FBK2__152917551 (COMPOSITECHANNELTB)". The window has a menu bar with "Apply Values" and a toolbar with various icons. Below the toolbar, there are checkboxes for "Periodic Updates" (checked) and "OOS" (set to "Auto"). A tabbed interface shows "Process" selected, with other tabs for "I/O Config", "Alarms", "Diagnostics", and "Others".

Parameter	Value	Type & Extensions	Help
PIPE_ID	90.0023 mm	R/W	Composite Pipe Inner Diameter
PIPE_OD	110.002 mm	R/W	Composite Pipe Outer Diameter
PIPE_WALL_THICKNESS	10 mm	R/W	Composite Pipe Wall Thickness
CORR_PEAK_LOW_LIMIT	1000	R/W	Composite Correlation Peak Low Limit
ANALOGOUT_PERCENTSCALE	0 %	R/W	Composite Analog out percent scale
ACCELERATION_LIMIT	15 m/s ²	R/W	Composite Acceleration Limit
AMP_DISC_MIN	14	R/W	Composite Amplitude discriminator min fr
AMP_DISC_MAX	32	R/W	Composite Amplitude discriminator max fr
KINEMATIC_VISCOSITY	1.004e-006 cSt	R/W	Composite Kinematic Viscosity
CALIBRATION_FACTOR	1	R/W	Composite Calibration Factor
ZERO_CUTOFF	0 m/s	R/W	Composite Zero Cutoff
RESPONSE_TIME	0.001 s	R/W	Composite Response Time
VELOCITY_LOW_LIMIT	-12.2 m/s	R/W	Composite Velocity Low limit - Used for V
VELOCITY_HIGH_LIMIT	12.2 m/s	R/W	Composite Velocity High limit - Used for V
VELOCITY_WARN_LOW_LIMIT	-12.2 m/s	R/W	Composite Velocity Warn Low limit - Alar
VELOCITY_WARN_HIGH_LIMIT	12.2 m/s	R/W	Composite Velocity Warn High limit - Ala
REFERENCE_DENSITY	1000 kg/m ³	R/W	Composite Reference Density for Stande
FLUID_SUPPLY_TEMPERATURE	10 °C	R/W	Supply Fluid Temperature for energy meo
FLUID_RETURN_TEMPERATURE	1.15705e-041 °C	R/W	Return Fluid Temperature for energy meo
SOS_LOW_LIMIT	762 m/s	R/W	SOS Low Limit
SOS_HIGH_LIMIT	1676.4 m/s	R/W	SOS High Limit
MULTI_VELREY_1	0.9 m/s	R/W	Composite Multi VelRey_1

At the bottom of the window, there are two buttons: "Write Changes" and "Read All".

Figure 28: Composite transducer block

Table 9: Available measurement values and parameters in the composite TB

Composite TB measurements and parameters	Measurement	Parameter
BATCH_FWD_TOTALS	R	
BATCH_REV_TOTALS	R	
BATCH_TOTAL_TIME	R	
SOUND_SPEED	R	
INVENTORY_FWD_TOTALS	R	
INVENTORY_REV_TOTALS	R	
INVENTORY_TOTAL_TIME	R	
MULTI_KFACTOR	R	
REYNOLDS_KFACTOR	R	
CURRENT_OPERATING_TEMP	R	
STANDARD_VOLUMETRIC	R	
BATCH_NET_TOTALS	R	
ERROR_STATUS	R	
HEALTH_CODE	R	
REPORTED_ERROR	R	
GATE_INPUT_STATE	R	
UNIT_TYPE_DENSITY_R	R	
UNIT_TYPE_VELOCITY_R	R	
UNIT_TYPE_TEMPERATURE_R	R	
PIPE_ID		R/W
PIPE_OD		R/W
PIPE_WALL_THICKNESS		R/W
CORR_PEAK_LOW_LIMIT		R/W
ANALOGOUT_PERCENTSCALE		R/W

Table 9: Available measurement values and parameters in the composite TB

Composite TB measurements and parameters	Measurement	Parameter
ACCELERATION_LIMIT		R/W
AMP_DISC_MIN		R/W
AMP_DISC_MAX		R/W
KINEMATIC_VISCOSITY		R/W
CALIBRATION_FACTOR		R/W
ZERO_CUTOFF		R/W
RESPONSE_TIME		R/W
VELOCITY_LOW_LIMIT		R/W
VELOCITY_HIGH_LIMIT		R/W
VELOCITY_WARN_LOW_LIMIT		R/W
VELOCITY_WARN_HIGH_LIMIT		R/W
REFERENCE_DENSITY		R/W
SOS_LOW_LIMIT, SOS_HIGH_LIMIT		R/W
MULTIK_VELREY_1-12, MULTIK_KFACTOR_1-12		R/W
REYNOLDS_CORRECTION		R/W
FLUID_SUPPLY_TEMPERATURE		R
FLUID_RETURN_TEMPERATURE		R
SOS_LOW_LIMIT		R/W
SOS_HIGH_LIMIT		R/W
MULTIK_VELREY		R/W
MULTIK_KFACTOR		R/W
PATHCONFIGURATION		R/W
HARDWARE_REVISION		R
SOFTWARE_REVISION		R

Table 9: Available measurement values and parameters in the composite TB

Composite TB measurements and parameters	Measurement	Parameter
UMPU_SERIAL_NUMBER		R
TOTALIZER_CMD		R/W
SENSOR_SERIAL_NUMBER		R
MULTIK_ACTIVE		R/W
MULTIK_TYPE		R/W
MULTIK_PAIRS		R/W
KVINPUT_SELECTION		R/W
ENABLE_ACTIVE_TW		R/W
CALIBR_MODE_SELECTION		R/W
PATH_ERROR_HANDLING		R/W
UNIT_TYPE_DIMENSION		R/W
UNIT_TYPE_TIME		R/W
UNIT_TYPE_VISCOSITY		R/W
UNIT_TYPE_STD_VOL		R/W
SYSTEM_SERIAL_NUMBER		R
FTP_SERIAL_NUMBER		R
VOLTAGE_SELECTION		R/W
ATTENUATOR_SELECTION		R/W

D.6.1 Clearing the totalizer

Batch totals can be controlled through foundation fieldbus (see *figure 29* below). The user can start, stop, or reset batch totalizers by setting the option on the **TOTALIZER_CMD** function of the **composite transducer block**. To set the totalizers from the foundation fieldbus:

1. Verify that the gate and ground terminals on the main PCB are connected.
2. Program the **CALIBR_MODE_SELECTION** parameter on the **composite transducer block** to **gate input**.

After these steps are complete, you can control the batch totalizer (start, stop, or reset) by selecting the desired option on **TOTALIZER_CMD** and writing the changes to the meter. No password is required for this function.

IMPORTANT:

The inventory totalizer can only be reset at the factory.

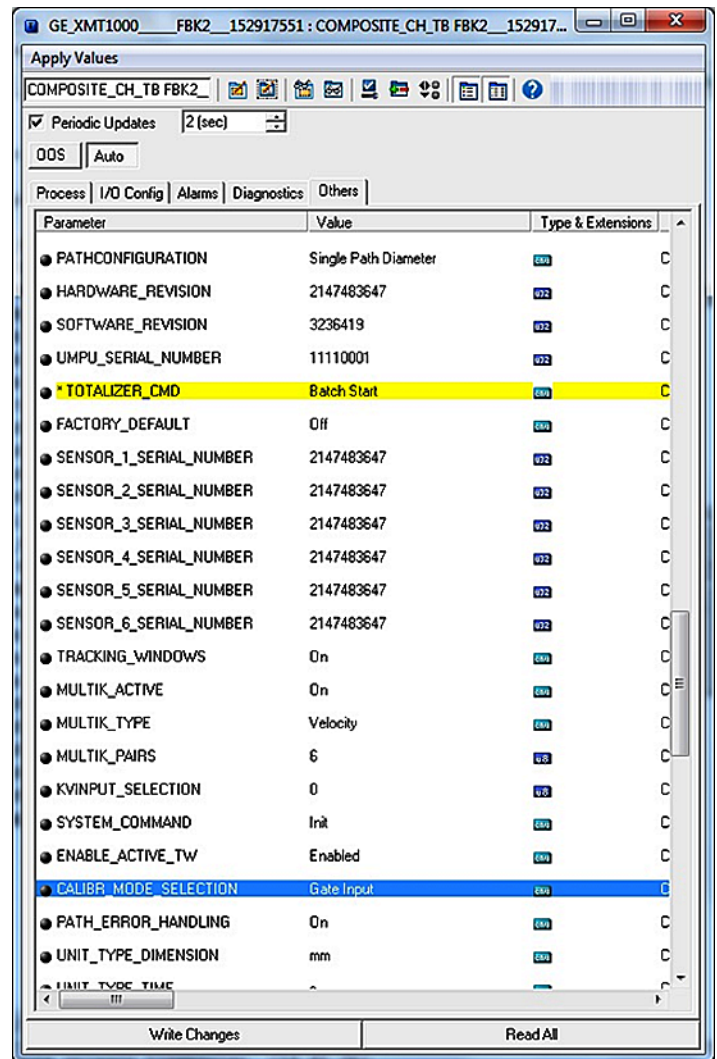

Figure 29: TOTALIZER_CMD function on composite TB

D.7 Channel transducer block

The **CH1**, **CH2** and **CH3** transducer blocks show the *measurement values* and *programmable parameters* for each of the three paths. *Figure 30* below shows the channel transducer block, and *table 10* lists the *measurements* and *parameters* that are available.

Note: The **R/W** designation means that the parameter is writable in FF using an **admin** password.

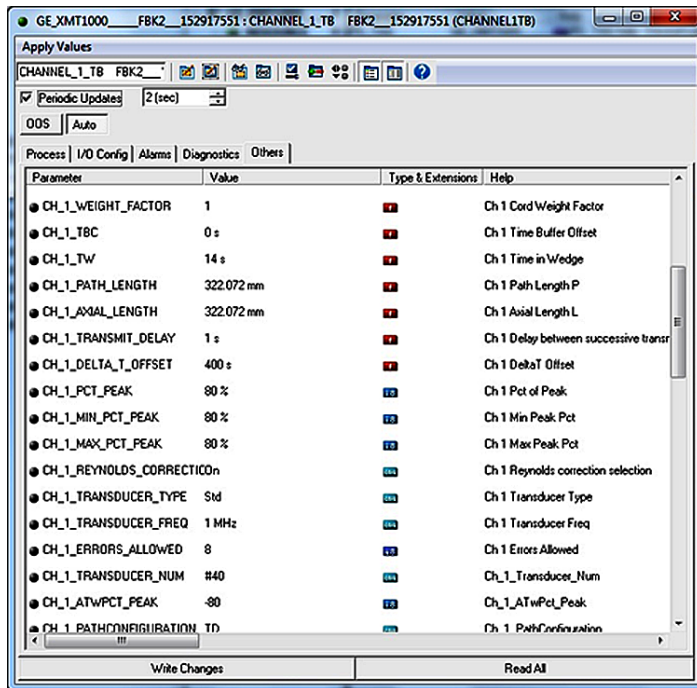

Figure 30: Channel transducer block

Table 10: Available measurement values and parameters in the channel TB

Channel TB measurements and parameters	Measurement	Parameter
CH_SOUND_SPEED	R	
CH_TRANSIT_TIME_UP	R	
CH_TRANSIT_TIME_DN	R	
CH_DELTA_T	R	
CH_UP_SIGNAL_QUALITY	R	
CH_DN_SIGNAL_QUALITY	R	
CH_UP_AMP_DISC	R	
CH_DN_AMP_DISC	R	

Table 10: Available measurement values and parameters in the channel TB

Channel TB measurements and parameters	Measurement	Parameter
CH_GAIN_UP	R	
CH_GAIN_DN	R	
CH_SNR_UP	R	
CH_SNR_DN	R	
CH_UP_PEAK	R	
CH_DN_PEAK	R	
CH_PEAK_PCT_UP	R	
CH_PEAK_PCT_DN	R	
CH_NUM_ERRORS_OF_16	R	
CH_WEIGHT_FACTOR		R/W
CH_TBC		R/W
CH_TW		R/W
CH_PATH_LENGTH		R/W
CH_AXIAL_LENGTH		R/W
CH_TRANSMIT_DELAY		R/W
CH_DELTA_T_OFFSET		R/W
CH_PCT_PEAK		R/W
CH_TRANSDUCER_TYPE		R/W
CH_TRANSDUCER_FREQ		R/W
CH_ERRORS_ALLOWED		R/W
CH_TRANSDUCER_NUMBER		R/W
CH_PATHCONFIGURATION		R/W

D.8 Analog input block

The analog input (AI) block (see *figure 31* below) is designed as a generalized signal conditioning function. The output from an AI block can be connected to the fieldbus. The AI block receives and processes data measured by the **transducer block** and provides additional functions such as scaling, filtering, alarm generation, and trending.

D.9 PID block

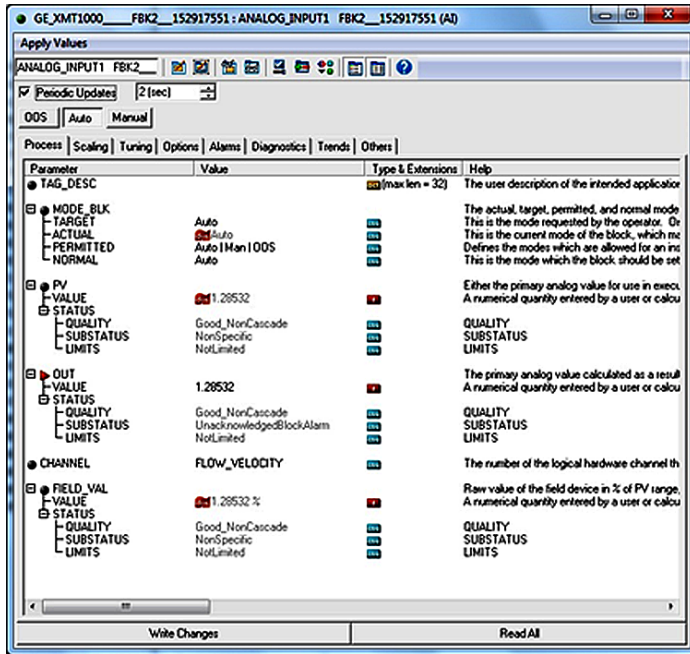

Figure 31: Analog input (AI) block

The PID function offers control based on a programmable algorithm. The PID function block may be used with a valve to control flow.

Note: See foundation fieldbus specifications for more detail on use of the PID block.

D.10 Error handling

The flow meter publishes the *error status* on the fieldbus along with the real data. The error status can be seen in the **CH_x_reported error** parameter on the **channel transducer block**. In addition, the **quality** parameter shown with each of the process variables reports the error. In *figure 32* below, the **CHI_REPORTED_ERROR** shows as **E1**.

Note: For more information on the actual measurement errors and possible causes, see *chapter 3, error codes and troubleshooting*.

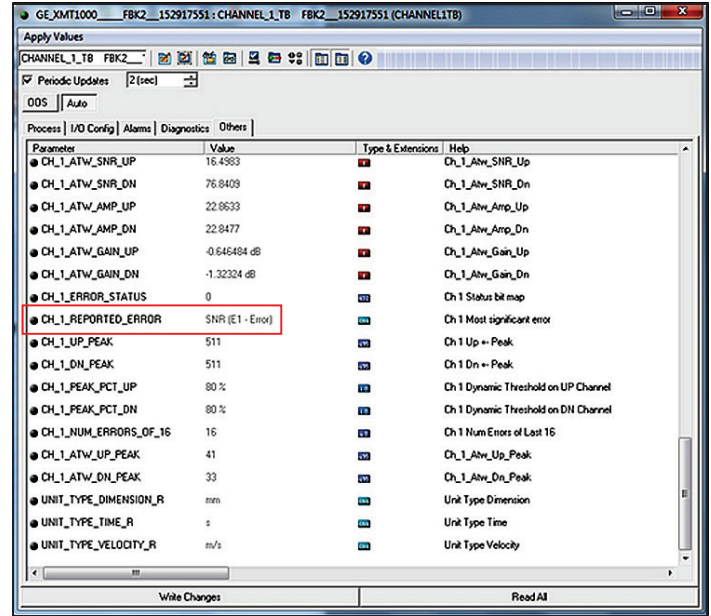

Figure 32: Reported error

Whenever the meter is in measurement error, the *quality bit* for the published parameter shows *bad quality* (see *figure 33* below). To change the quality bit to *good*, the measurement error at the meter must be removed.

Notice the **QUALITY.STATUS** field shows as **bad** and the **SUBSTATUS** field shows as **sensor failure**. This information indicates a measurement error which must be corrected.

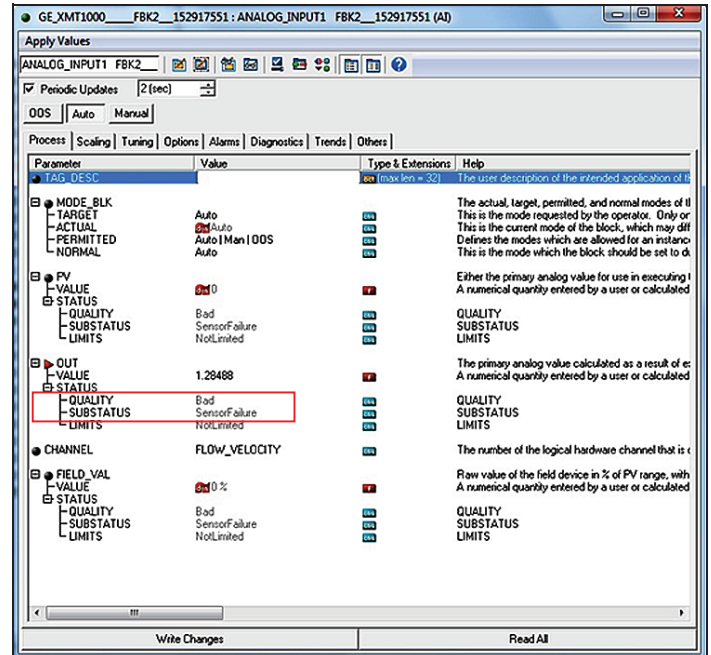

Figure 33: Quality bit error

D.11 Simulation mode

Simulation mode allows the user to test the FF implementation without the instrument providing real data. The meter PCB is shipped with simulation mode disabled. To enable simulation mode, complete the following steps:



CAUTION!

To prevent damage to the electronic components, always use **ESD** protection whenever handling printed circuit boards.

1. Remove the PCB from the meter.
2. Locate the jumper **P5** (see *figure 34* below).
3. Move the **P5** jumper to the left one place (pins 2 and 3) to enable simulation mode.
4. Re-install the PCB into meter
5. Verify that the **block** error field in the **resource block** shows *SimulationActive* status.

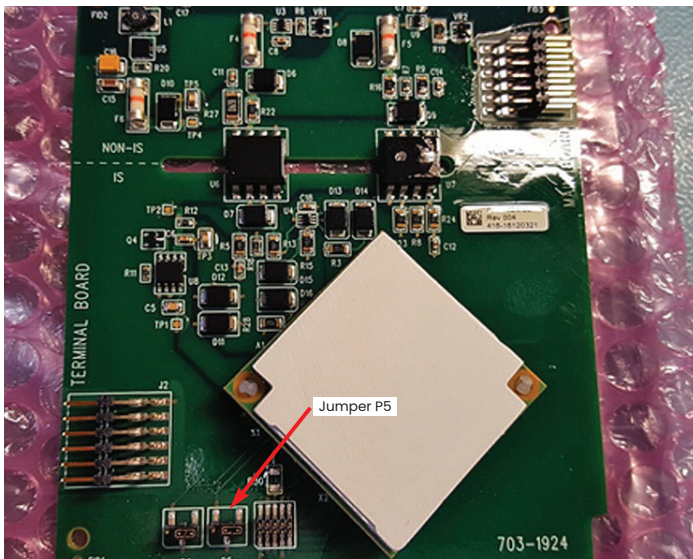

Figure 34: P5 on XMT1000 PCB



D.12 Fieldbus troubleshooting guide

See *table 11* below for suggested solution to possible fieldbus problems.

Table 11: XMT1000 FF troubleshooting guide		
Problem	Presumed Cause	Remedy
Communication between DCS and XMT1000 FF cannot be established	Wiring unconnected, broken or shorted	Correct wiring between XMT1000 and spur device coupler.
	The power is off or the power supply voltage is less than 9 V	Supply proper voltage
	The address detection range is not correctly set in the DCS	Correct address detection range - default address for XMT1000 is 0x17
Communication with the XMT1000 FF is frequently cut off.	The fieldbus is experiencing a large amount of noise.	Using an oscilloscope or another fieldbus health monitor to check the waveform on the fieldbus.
	Missing terminators on the bus, incorrect terminator placement or extra terminators.	Refer to FOUNDATION fieldbus specifications for a full discussion of terminator requirements.
A value cannot be written to a parameter in the XMT1000 FF.	Not in configuration mode.	Enter correct "admin" password in resource block - verify "SI - configuration mode" appears on XMT1000 UI
	You have attempted to write a value outside the valid range.	Check the setting range of parameters.
	The present mode does not allow write access.	Change the target mode.
	The jumper is in write protected configuration.	Contact factory for write protect jumper configuration
The actual mode of a function block differs from the target mode.	Resource block in OOS.	Change the target mode of the resource block to auto.
	Schedules that define when function blocks execute are not set correctly.	Set the schedules using a configuration tool.
	The transducer block is not in auto mode.	Change the target mode of the transducer block to auto.
A block's dynamic parameters do not update.	XMT1000 is powered down	Verify the XMT1000 is powered on and measuring properly
	XMT1000 does not recognize the FF PCB	Check Options menu on XMT1000 UI for fieldbus option - if it appears the meter knows it is present

D.13 DPI620 FF modular communicator

For local diagnostic capability with the XMT1000 FF option, Panametrics recommends the **DPI620G-FF Genii** advanced modular calibrator and HART/fieldbus communicator. The calibrator is available in an IS version as well (**DPI620G-IS-FF**). *Table 12* below lists the models, description and key benefits.

Table 12: DPI620 Genii models			
Image	Model PN	Description	Key Benefits
	DPI620G-FF	Genii advanced modular calibrator and HART/fieldbus communicator	<ul style="list-style-type: none"> • Fully featured communicators for device configuration, trimming and calibration • Complete device description (DD) libraries • Internal power hub • Free software and DD updates via simple web download
	DPI620G-IS-FF	Genii intrinsically safe advanced modular calibrator and HART/fieldbus communicator	



Attention!

For more information, see the DPI620 website: <https://www.bakerhughesds.com/druck/test-and-calibration-instruments>

Index

A

Analog input block.....vi, 63
Analog output 5, 24
Arrow keys 9
Auxiliary equipment viii

B

Backlight..... 10
Block, analog input.....vi, 63
block, channel transducer.....vi, 62
Block, PID.....63
Block, resource..... vi, 53, 54, 65

C

Cable, transducers22
Cable, lengths 4
Calibration port, wiring 6
CE marking compliance1, 5, 6, 7
Channel transducer block.....vi, 62
Communication error string..... 19
Composite transducer blockvi, 59
Corrosion, transducers22

D

Data logging.....23
Diagnostics 21
Digital outputs, wiring..... v, 6, 24
Down arrow key..... 9
DPI620 FF modular communicator.....66

E

Electrical connectionsv, 5
Electronics classifications24
Electronics, dimensions.....24
Electronics, display21, 24, 29, 30, 31
Electronics enclosure5, 6, 7, 21
Electronics, enclosure..... 3, 24
Electronics mounting24
Environmental compliance..... v, viii
Error codes and troubleshooting v, 19
Error display in the user interface..... v, 19

Error handling.....vi, 10, 63
Error header 19
Error string, communication v, 19
Error string, flow.....v, 20

F

FF revision.....vi, 54
Fieldbus, troubleshooting guidevi, 65
Flow accuracy (velocity).....23
Flowcell problems, fluid.....21, 23
Flowcell problems, pipe.....21, 23
Flowcell, problems v, 21
Flow error string.....v, 20
Fluid.....21, 23
Fluid, Soundspeed20
Fluid problems..... 21
Fluid, types.....23
Foundation fieldbus, communication vi, 51
Foundation fieldbus, connection vi, 1, 24, 51
Foundation fieldbus, DD file.....vi, 52
Foundation fieldbus, default node address.....vi, 52
Foundation fieldbus, FISCO vi, 52, 53
Foundation fieldbus, installation.....v, vi, 1, 51
Foundation fieldbus, network configuration vi, 51
Foundation fieldbus, polarityvi, 51, 53
Foundation fieldbus, specifications.....vi, 23, 24, 53
Frequency output, wiring 10

G

Glossary of terms..... v, 10
Grounding1

H

HARTvi, 10, 11, 21, 24, 32, 34, 35, 37, 48, 49, 50, 66
HART, communicationvi, 48
HART, menu mapsvi, 49
HART, wiring.....vi, 48
HART, write mode switchvi, 48
Humidity (operating and storage).....24

I	
Inputs/outputs	24
Internal damage, transducer	22
K	
Keypad	24
Keypad program, exit if unused	9
K-factor	10
L	
Languages, display	24
Leaks, transducer	22
Left arrow key	9
Line power, wiring	v, 7
Local safety standards	viii
Loop powered	10
M	
Magnetic keypad	v, 9
Mass flow	10, 58
Measurement parameters	23, 57
Menu maps	v, 11
Meter, access to	v, 3
Meter turndown	23
Modbus	vi, 10, 25, 56
Modbus, communication	vi, 25, 56
Modbus, protocol	vi, 25
Modbus, register map	vi, 25
Mounting, electronics	24
Mounting, local	v, 4, 24
Mounting, remote	v, 4, 24
O	
Operating temperature	24
Operation and performance	vi, 23
Optional pc software	23

P	
Unpacking	1, 2
Wiring diagram	48
Passcodes	9
Password	vi, 54
Paths	24
Personal safety equipment	viii
Physical damage	22
PID block	vi, 63
Pipe	21, 23
Pipe problems	21
Pipe sizes	23
Power	1, 24, 51
Power consumption	24
Power supplies	24
Product registration	v, vii
Programming	v, 9
Pulse output	10
Q	
Qualification of personnel	viii
R	
Registration	v, vii
Repeatability	23
Resource block	vi, 53, 54, 65
Reynolds correction	10
Right arrow key	9
RoHS	viii, 24
S	
Auxiliary equipment	viii
Safety	vii
Safety codes	1
Serial port settings	10
Services	v, vii
Simulation mode	vi, 64
Site and clearance considerations	v, 3
Fluid	21, 23
Soundspeed	20
Special transducer	10
Specifications	23, 24, 53
Storage temperature	24
Sunlight exposure	v, 3

T

Terminal blocks	24
Terms and conditions	vii
Totalizer	10, 26, 30
Totalizer, clearing	vi, 61
Tracking window	10
Transducer block, composite t.	vi, 59
Transducer block, XMIT	vi, 57, 58
Transducer/buffer problems	v, 22
Transducer, cables	4
Transducer, corrosion damage	22
Transducer, internal damage	22
Transducer, leaks	22
Transducer, physical damage	22
Transducer, types	23
TW parameter	10
Typographical conventions	vii

U

Unauthorized operation	viii
Units	vi, 25, 57, 58
Unpacking	1, 2
Up arrow key	9

V

Vibration exposure	v, 3
Vitality™ PC	23
Voltage, inputs	7, 9

W

Warranty	vii
WEEE directive	viii
Wiring, CE marking compliance	1, 5, 6, 7
Wiring, digital outputs	24
Wiring, frequency output	10
Wiring, analog outputs	v, 5
Wiring, calibration port	6
Wiring, connection	24
Wiring, diagram	8
Wiring, digital output	v, 6
Wiring, frequency output	6
Wiring, line power	v, 7
Wiring, modbus/service port	6
Wiring, totalizer (pulse) output	6
Working area	viii

X

XMIT transducer block	vi, 57, 58
-----------------------	------------

Z

Zero cutoff	10
-------------	----

Customer support centers

Americas

U.S.A.

The Boston Center
1100 Technology Park Drive
Billerica, MA 01821

U.S.A.

Tel: +1 800 833 9438 (toll-free)

Tel: +1 978 437 1000

E-mail: mstechsupport@bakerhughes.com

Europe

Ireland

Sensing House
Shannon Free Zone East
Shannon, County Clare
Ireland

Tel: +353 61 61470200

E-mail: mstechsupport@bakerhughes.com

Panametrics, a Baker Hughes Business, provides solutions in the toughest applications and environments for moisture, oxygen, liquid and gas flow measurement. Experts in flare management, Panametrics technology also reduces flare emissions and optimizes performance.

With a reach that extends across the globe, Panametrics' critical measurement solutions and flare emissions management are enabling customers to drive efficiency and achieve carbon reduction targets across critical industries including: Oil & Gas; Energy; Healthcare; Water and Wastewater; Chemical Processing; Food & Beverage and many others.

Join the conversation and follow us on LinkedIn
[linkedin.com/company/panametricscompany](https://www.linkedin.com/company/panametricscompany)