

21000 and 24701 Proximity Probe Housing Assemblies

Datasheet

Bently Nevada Machinery Condition Monitoring

141600 Rev. V

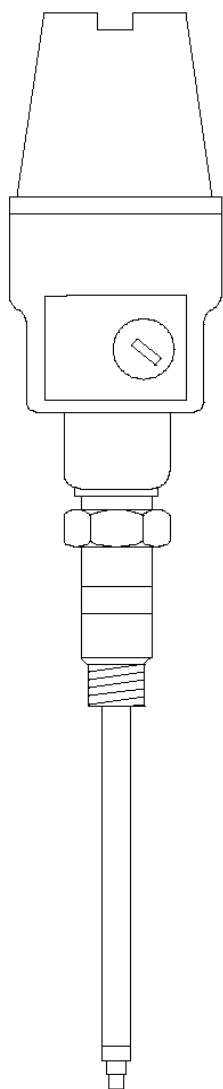

Description

To externally mount proximity probes, use one of these all-metal Proximity Probe Housing Assemblies:

- 21000 aluminum probe housing assembly
- 24701 stainless steel probe housing assembly

The 21000 and 24701 Proximity Probe Housing Assemblies consist of the following parts:

- A dome cover that screws into the body of the housing
- Threaded ports for conduit connections
- A probe sleeve of optional length
- O-rings
- A reverse mount proximity probe
- A thread seal
- Optional conduit fittings
- An optional standoff adapter



A newer 31000/32000 proximity probe housing assembly is available with more flexible mounting options, better environmental resistance, and other improved features. We recommend this proximity probe housing assembly for installations where an explosion proof housing is not required. See 31000 and 32000 Proximity Probe Housings product datasheet (document 141610).

The 21000 and 24701 Proximity Probe Housing Assemblies are available with Canadian Standards Association (CSA) approvals. They are rated explosion proof for hazardous areas.



You can order hazardous area approved proximity probes with 21000 aluminum and 24701 stainless steel housings for intrinsically safe applications. Both housings are certified as CSA Type 4 enclosures and are fully compliant with the American Petroleum Institute's (API) 670 Standard for externally mounted proximity probe housings.

The 164818 Compact Proximity Probe Housing is also available for applications with space restrictions. Ceramic capped probes are available with the 164818 housing.

Sleeve length is determined by the location in which the probe and housing are installed. The probe lead must be longer than the sleeve. Sleeve lengths longer than 304 mm (12 inches) require additional sleeve support to reduce the vibration associated with unsupported long sleeve lengths.

Bently Nevada offers a probe support and oil seal (part number 37948-01) for long sleeves that must go through an inner bearing housing. We also make custom sleeve supports.

Related Documents

For probe information, refer to the following manuals:

- *3300 XL 8mm & 3300 5mm Proximity Transducer System User Guide* (document 141078)
- *3300 XL NSv Proximity Transducer System User Guide* (document 147357)
- *3300 XL 11mm Proximity Transducer System Installation User Guide* (document 146255)
- *Radiation Resistant Probe and Proximitor System* (document TW8029407)

Specifications

Environmental

Temperature Range

3300 XL 8mm Probe

| | |
|-----------------------|-----------------------------------|
| Operating and storage | -51°C to +177°C (-60°F to +351°F) |
|-----------------------|-----------------------------------|

3300 XL 11mm Probe

| | |
|-----------------------|-----------------------------------|
| Operating and storage | -51°C to +177°C (-60°F to +351°F) |
|-----------------------|-----------------------------------|

3300 NSv Probe

| | |
|-----------|-----------------------------------|
| Operating | -34°C to +177°C (-30°F to +351°F) |
|-----------|-----------------------------------|

| | |
|---------|-----------------------------------|
| Storage | -51°C to +177°C (-60°F to +351°F) |
|---------|-----------------------------------|

| | |
|----------------|--------------------------|
| Monitor Module | 1 full-height front slot |
| I/O Modules | 1 full-height rear slot |

CAUTION

EQUIPMENT DAMAGE

Exposing 3300 XL or 3300 NSv probes to temperatures below -34°C (-30°F) may cause premature failure of their pressure seals.

Mechanical

Material

| | |
|-------|---|
| 21000 | Aluminum body with 304 stainless steel sleeve |
|-------|---|

| | |
|-------|---|
| 24701 | 303 stainless steel body, with 304 stainless steel sleeve |
|-------|---|

Mass (Weight)

| | |
|-------|---|
| 21000 | 1.1 kg (2.4 lb) typical, without fittings |
|-------|---|

| | |
|-------|---|
| 24701 | 1.8 kg (4.1 lb) typical, without fittings |
|-------|---|

Compliance and Certifications

RoHS

European Community Directive:
RoHS Directive 2011/65/EU

Hazardous Area Approvals



For the detailed listing of country and product specific approvals, refer to the *Approvals Quick Reference Guide* (108M1756) available from Bently.com.

21000 and 24701

CA housings are certified by CSA for explosion-proof applications in the following areas:

| | |
|---------------|---|
| North America | Class I Divisions 1 and 2 Groups C and D Class II Divisions 1 and 2 Groups E, F and G Circuit is non-incendive when connected per drawing 140979 Class III Enclosure Type 4 T5 @ Ta = -50°C to +40°C T4 @ Ta = -50°C to +80°C |
|---------------|---|

Ordering Information



For the detailed listing of country and product specific approvals, refer to the *Approvals Quick Reference Guide* (108M1756) available from Bently.com.

Proximity Probe Housing Assemblies

21000-AA-BB-CC-DDD-EE-FF

A: Probe with Connector

| | |
|-----------|---|
| 00 | Probe not required |
| 14 | 420 nuclear |
| 16 | 3300 XL 8mm probe |
| 26 | 3300 XL NSv probe |
| 27 | 3300 XL NSv probe, selectable hazardous area approvals |
| 28 | 3300 XL 8mm probe, selectable hazardous area approvals |
| 29 | 3300 XL 11mm probe |
| 30 | 3300 XL 11mm probe, selectable hazardous area approvals |
| 31 | 3300 XL NSv probe with connector protector |
| 32 | 3300 XL NSv probe with connector protector, selectable hazardous area approvals |
| 33 | 3300 XL 8mm probe with connector protector |
| 34 | 3300 XL 8mm probe with connector protector, selectable hazardous area approvals |
| 35 | 3300 XL 11mm probe with connector protector |

| | |
|-----------|--|
| 36 | 3300 XL 11mm probe with connector protector, selectable hazardous area approvals |
| 37 | 3300 XL 8mm probe, ETR, selectable hazardous area approvals (available for 21000 only) |

B: Probe Cable Length

| | |
|-----------|--------------------------|
| 00 | Probe cable not required |
| 05 | 0.5 m (20 in) |
| 10 | 1.0 m (39 in) |
| 12 | 12.0 in |
| 18 | 18.0 in |
| 24 | 24.0 in |
| 30 | 30.0 in |
| 36 | 36.0 in |

C: Standoff Adapter (Option C Dimension)

| | |
|-----------|--------------------------------|
| 15 | Minimum length 1.5 in (38 mm) |
| 75 | Maximum length 7.5 in (191 mm) |

Recommendation

Order in increments of 0.5 in (13 mm)

Examples

1.5 in (38 mm) = **15**
 No standoff adapter = **00**

D: Probe Penetration (Option D Dimension)

| | |
|--------------|---------------------------------|
| 10 | Minimum length 1.0 in (25.4 mm) |
| Other | |

Recommendation

Order in increments of 0.1 in (3 mm)

Examples

3.7 in (94 mm) = **037**
 2.4 in (569 mm) = **224**

 Probe P/N and S/N may be displayed on a flag label for some combinations of the C plus D options where only a small section of the probe cable is visible.

 For probe penetration lengths between 1.0 and 2.0 inches, it may be necessary to counter bore the machine case to reduce probe side view or rear view effects.

 If you select a probe penetration length (C plus D) greater than 300 mm (12 in), you must add sleeve support near the probe to prevent resonance from occurring. Adjustment range of probe penetration option D is 13 mm (± 0.5 in). For the maximum value of C plus D, [see 21000/CA21000 Dimensions on page 1](#).

E: Fittings

| | |
|-----------|---|
| 00 | Without fittings |
| 01 | One 3/4-14 NPT explosion-proof fitting One 3/4-14 NPT plug |
| 02 | Two 3/4-14 NPT explosion-proof fittings |
| 03 | One 3/4-14 NPT plug One 3/4-14 to 1/2-14 NPT reducer One cable seal grip with grommets for the following cable sizes: <ul style="list-style-type: none"> • 1/8 to 3/16 inches • 1/4 to 5/16 inches • 5/16 to 3/8 inches |
| 04 | One 3/4-14 NPT plug only |

 Although explosion-proof fittings are available for all housings, only CA versions of the housing are rated as

 explosion-proof by CSA when ordered with the **E:00**, **E:01**, **E:02**, or **E:04** options.

F: Mounting Thread

| | |
|-----------|---|
| 01 | As cast without threads |
| 02 | 3/4-14 NPT  Must be ordered if Standoff Adapter Length option is not 00 . |
| 04 | 1/2-14 BSP |

24701-AA-BB-CC-DDD-EE-FF

A: Probe with Connector

| | |
|-----------|--|
| 00 | Probe not required |
| 14 | 420 nuclear |
| 16 | 3300 XL 8mm probe |
| 26 | 3300 XL NSv probe |
| 27 | 3300 XL NSv probe, with approval option |
| 28 | 3300 XL 8mm, with approval option |
| 29 | 3300 XL 11mm |
| 30 | 3300 XL 11mm, with approval option |
| 31 | 3300 XL NSv with connector protector |
| 32 | 3300 XL NSv with connector protector and approval option |
| 33 | 3300 XL 8mm with connector protector |
| 34 | 3300 XL 8mm with connector protector and approval option |
| 35 | 3300 XL 11mm with connector protector |

| | |
|-----------|---|
| 36 | 3300 XL 11mm with connector protector and approval option |
| 37 | 3300 XL 8mm ETR, with approval option |

B: Probe Cable Length

| | |
|-----------|--------------------------|
| 00 | Probe cable not required |
| 05 | 20 in (0.5 m) |
| 10 | 39 in (1.0 m) |
| 12 | 12.0 ft (3.6 m) |
| 18 | 18.0 ft (3.6 m) |
| 24 | 24.0 ft (7.3 m) |
| 30 | 24.0 ft (7.3 m) |
| 36 | 36.0 ft (10.9 m) |

C: Standoff Adapter (Option C Dimension)

| | |
|-----------|--------------------------------|
| 15 | Minimum length 1.5 in (38 mm) |
| 75 | Maximum length 7.5 in (191 mm) |

Examples

1.5 in (38 mm) = **15**
 No standoff adapter = **00**

Recommendation

Order in increments of 0.5 in (13 mm)

D: Probe Penetration (Option D Dimension)

| | |
|--------------|--|
| 010 | Minimum length 1.0 in (25.4 mm) |
| Other | See 21000/CA21000 Dimensions on page 1. |
| | Example 3.7 in (94 mm) = 037 22.4 in (569 mm) = 224 |
| | Recommendation Order in increments of 0.1 in (3 mm) |



Probe P/N and S/N may be displayed on a flag label for some combinations of the C plus D options where only a small section of the probe cable is visible.



For probe penetration lengths between 1.0 and 2.0 inches, it may be necessary to counter bore the machine case to reduce probe side view or rear view effects.



If you select a probe penetration length (C plus D) greater than 300 mm (12 in), you must add sleeve support near the probe to prevent resonance from occurring. Adjustment range of probe penetration option D is 13 mm (± 0.5 in). For the maximum value of C plus D, [see 21000/CA21000 Dimensions on page 1.](#)

E: Fittings

| | |
|-----------|---|
| 00 | Without fittings |
| 01 | One 3/4-14 NPT explosion-proof fitting One 3/4-14 NPT plug |
| 02 | Two 3/4-14 NPT explosion-proof fittings |
| 03 | One 3/4-14 NPT plug One 3/4-14 to 1/2-14 NPT reducer One cable seal grip with grommets for the following cable sizes: • 1/8 to 3/16 inches • 1/4 to 5/16 inches • 5/16 to 3/8 inches |
| 04 | One 3/4-14 NPT plug only |

 Although explosion-proof fittings are available for all housings, only CA versions of the housing are rated as explosion-proof by CSA when ordered with the **E:00**, **E:01**, **E:02**, or **E:04** options.

F: Mounting Thread

| | |
|-----------|--|
| 01 | As cast without threads |
| 02 | 3/4-14 NPT (see note [1] below)  Must be ordered if Standoff Adapter Length Option is not 00. |
| 03 | 1-11 1/2 NPT (see note [1] below) |
| 04 | 1/2-14 BSP |
| 05 | 7/8-14 UNF-2A |

 (1) For CA21000 housing, option F must be 02. Options 02 and 03 for mounting threads have more threads than standard NPT threads. They have been machined to have approximately 5 - 7 full threads to increase mounting strength and stiffness.

Explosion-Proof Housing Assemblies

 For CA21000 housing, option F must be 02. Options 02 and 03 for mounting threads have more threads than standard NPT threads. They have been machined to have approximately 5 - 7 full threads to increase mounting strength and stiffness.

CA21000-AA-BB-CC-DDD-EE-F02

 Options **A:00** and **B:00** are linked. If you choose **A:00**, you must also select **B:00**.

A: Probe with Connector

| | |
|-----------|--|
| 00 | Probe not required |
| 01 | 190 series, CSA, BNPS connector |
| 02 | 190 series, CSA, API connector |
| 27 | 3300 XL NSv, multiple approval |
| 28 | 3300 XL 8mm, multiple approval |
| 30 | 3300 XL 11mm, multiple approval |
| 32 | 3300 XL NSv with connector protector, multiple approval |
| 34 | 3300 XL 8mm with connector protector, multiple approval |
| 36 | 3300 XL 11mm with connector protector, multiple approval |

B: Probe Cable Length

| | |
|-----------|-----------------------|
| 05 | 0.5 meter (20 inches) |
| 20 | 1.0 meter (39 inches) |

C: Standoff Adapter (Option C Dimension)

| | |
|-----------|--------------------------------|
| 15 | Minimum length 1.5 in (38 mm) |
| 75 | Maximum length 7.5 in (191 mm) |

| | |
|--|--|
| | <p>Example</p> <p>1.5 in (38 mm) = 15</p> <p>No Standoff adapter = 00</p> |
| | <p>Recommendation</p> <p>Order in increments of 0.5 in (13 mm)</p> |

D: Probe Penetration (Option D Dimension)

| | |
|--------------|---|
| 010 | Minimum length 1.0 in (25.4 mm) |
| Other | See 21000/CA21000 Proximity Probe Housing Assembly on page 16. |
| | <p>Example</p> <p>3.7 in (94 mm) = 037</p> <p>22.4 in (569 mm) = 224</p> |
| | <p>Recommendation</p> <p>Order in increments of 0.1 in (3 mm)</p> |

 Probe P/N and S/N may be displayed on a flag label for some combinations of the C plus D options where only a small section of the probe cable is visible.

 For probe penetration lengths between 1.0 and 2.0 inches, it may be necessary to counter bore the machine case to reduce probe side view or rear view effects.

 If you select a probe penetration length (C plus D) greater than 300 mm (12 in), you must add sleeve support near the probe to prevent resonance from occurring. Adjustment range of probe penetration option D is 13 mm (± 0.5 in). For the maximum value of C plus D, [see 21000/CA21000 Dimensions on page 1.](#)

E: Fittings

| | |
|-----------|--|
| 00 | Without fittings |
| 01 | One 3/4-14 NPT explosion-proof fitting One 3/4-14 NPT plug |
| 02 | Two 3/4-14 NPT explosion-proof fittings |
| 03 | One 3/4-14 NPT plug One 3/4-14 to 1/2-14 NPT reducer One cable seal grip with grommets for the following cable sizes: <ul style="list-style-type: none"> • 1/8 to 3/16 inches • 1/4 to 5/16 inches • 5/16 to 3/8 inches |
| 04 | One 3/4-14 NPT plug only |

 Although explosion-proof fittings are available for all housings, only CA versions of the housing are rated as explosion-proof by CSA when ordered with the E:00, E:01, E:02, or E:04 options.

For non-explosion-proof housings, if you choose a probe with selectable hazardous area approvals, you must choose a probe with matching approval options.

When ordering a proximator and an extension cable with the housing, choose a probe with matching approval options.

 You can only order probes for CA21000 or CA24701 with multiple approvals. To order CA versions with no probe, select the A:00 option.

CA24701-AA-BB-CC-DDD-EE-FF

A: Probe with Connector

| | |
|-----------|---------------------------------|
| 00 | Probe not required |
| 01 | 190 series, CSA, BNPS connector |

| | |
|-----------|--|
| 02 | 190 series, CSA, API connector |
| 27 | 3300 XL NSv , multiple approval |
| 28 | 3300 XL 8mm, multiple approval |
| 30 | 3300 XL 11mm, multiple approval |
| 32 | 3300 XL NSv with connector protector, multiple approval |
| 34 | 3300 XL 8mm with connector protector, multiple approval |
| 36 | 3300 XL 11mm with connector protector, multiple approval |

B: Probe Cable Length

| | |
|-----------|--------------------------|
| 00 | Probe cable not required |
| 05 | 20 in (0.5 m) |
| 10 | 39 in (1.0 m) |
| 12 | 12.0 ft (3.6 m) |
| 18 | 18.0 ft (3.6 m) |
| 24 | 24.0 ft (7.3 m) |
| 30 | 24.0 ft (7.3 m) |
| 36 | 36.0 ft (10.9 m) |

C: Standoff Adapter (Option C Dimension)

| | |
|-----------|--|
| 15 | Minimum length 1.5 in (38 mm) |
| 75 | Maximum length 7.5 in (191 mm) |
| | Examples 1.5 in (38 mm) = 15 No standoff adapter = 00 |
| | Recommendation Order in increments of 0.5 in (13 mm) |

D: Probe Penetration (Option D Dimension)

| | |
|--------------|--|
| 010 | Minimum length 1.0 in (25.4 mm) |
| Other | See 24701/CA24701 Proximity Probe Housing Assembly on page 17. |

| | |
|--|--|
| | Example 3.7 in (94 mm) = 037 22.4 in (569 mm) = 224 |
| | Recommendation Order in increments of 0.1 in (3 mm) |

 Probe P/N and S/N may be displayed on a flag label for some combinations of the C plus D options where only a small section of the probe cable is visible.

 For probe penetration lengths between 1.0 and 2.0 inches, it may be necessary to counter bore the machine case to reduce probe side view or rear view effects.

 If you select a probe penetration length (C plus D) greater than 300 mm (12 in), you must add sleeve support near the probe to prevent resonance from occurring. Adjustment range of probe penetration option D is 13 mm (± 0.5 in). For the maximum value of C plus D, [see 21000/CA21000 Dimensions on page 1.](#)

E: Fittings

| | |
|-----------|---|
| 00 | Without fittings |
| 01 | One 3/4-14 NPT explosion-proof fitting One 3/4-14 NPT plug |
| 02 | Two 3/4-14 NPT explosion-proof fittings |

| | |
|-----------|---|
| 03 | <p>One 3/4-14 NPT plug One 3/4-14 to 1/2-14 NPT reducer</p> <p>One cable seal grip with grommets for the following cable sizes:</p> <ul style="list-style-type: none"> • 1/8 to 3/16 inches • 1/4 to 5/16 inches • 5/16 to 3/8 inches |
| 04 | One 3/4-14 NPT plug only |

 (1) For CA21000 housing, option F must be 02. Options 02 and 03 for mounting threads have more threads than standard NPT threads. They have been machined to have approximately 5 - 7 full threads to increase mounting strength and stiffness.

 Although explosion-proof fittings are available for all housings, only CA versions of the housing are rated as explosion-proof by CSA when ordered with the E:00, E:01, E:02, or E:04 options.

For non-explosion-proof housings, if you choose a probe with selectable hazardous area approvals, you must choose a probe with matching approval options.

When ordering a proximator and an extension cable with the housing, choose a probe with matching approval options.

 You can only order probes for CA21000 or CA24701 with multiple approvals. To order CA versions with no probe, select the A:00 option.

F: Mounting Thread

| | |
|-----------|--|
| 01 | As cast without threads |
| 02 | <p>3/4-14 NPT (see note [1] below).</p> <div style="border: 1px solid black; padding: 5px; margin-top: 10px;"> <p> Must be ordered if Standoff Adapter Length Option is not 00.</p> </div> |
| 03 | 1-11 1/2 NPT (see note [1] below) |
| 04 | 1/2-14 BSP |
| 05 | 7/8-14 UNF-2A |

164818 Compact Proximity Probe Housing

164818-AA-BB-CCC-DD-EE-FF-GG

| A: Probe with Connector | |
|-------------------------|--|
| 00 | No probe |
| 01 | 3300 XL NSv probe |
| 02 | 3300 XL 8mm probe |
| 03 | 3300 XL 11mm probe |
| 04 | 3300 8mm ceramic-capped probe |
| 05 | 3300 XL NSv probe with multiple approvals |
| 06 | 3300 XL 8mm probe with multiple approvals |
| 07 | 3300 XL 11mm probe with multiple approvals |
| 08 | 3300 8mm Ceramic Capped Probe with multiple approvals |
| 12 | 3300 XL 8mm probe with connector protector |
| 16 | 3300 XL 8mm probe with connector protector, multiple approvals |
| B: Cap Height | |
| 20 | 2.0 inches |
| 40 | 4.0 inches |
| 60 | 6.0 inches |
| C: Sleeve Length | |
| 016 | Minimum length 1.6 in (40.6 mm) |
| 292 | Maximum length 29.2 in (741.7 mm) |
| | Examples |
| | 3.0 in (76.2mm) = 030 |
| | 22.4 in (569 mm) = 224 |

| Recommendation | |
|-----------------------|--------------------------------------|
| | Order in increments of 0.1 in (3 mm) |
| D: Mounting Thread | |
| 01 | 3/4-14 NPT |
| 02 | G 3/4 (3/4-14 BSPP) |
| 03 | M24 x 1.5 |
| E: O-ring Option | |
| 01 | Viton |
| 02 | Neoprene |
| 03 | Ethylene propylene |
| F: Rear Thread Type | |
| 01 | 1/2-14 NPT |
| 02 | M16 x 1.5 |
| 03 | M20 x 1.5 |
| G: Probe Cable Length | |
| 05 | 0.5 meter (20 in) |
| 10 | 1.0 meter (39 in) |

Accessories

| Part Number | Description |
|-------------|--|
| 37948-01 | Probe Support / Oil Seal Recommended for sleeves longer than 305 mm (12 in) |

Individual Probe Sleeve for 21000/24701 Proximity Probe Housings 44382-AAA

| A: Measured Probe Sleeve Length | |
|---------------------------------|--------------------------------------|
| | Recommendation |
| | Order in increments of 0.1 in (3 mm) |

The individual probe sleeve length does **not** include the distance from the end of the sleeve to the probe tip or the gap from the probe tip to the target material. If only the part number of the original housing is known, and the sleeve cannot be measured, use the following table to determine the sleeve length:

| AAA | Description |
|--|---|
| Standoff adapter option from original housing (21000, CA21000, 24701, or CA24701 option C) plus Probe penetration option from original housing (21000, CA21000, 24701, or CA24701 option D) and 045 | All housing AAA options except NSv and 11mm probes (options other than A:06, A:12, A:26, A:27, A:29, A:30, A:31, A:32, A:35, or A:36) Example Original part number 21000-16-10-15-035-03-02 AAA option for replacement sleeve (015 + 035 + 045) = 095 |
| Standoff Adapter Option from original housing (21000, CA21000, 24701, or CA24701 option C) plus Probe penetration option from original housing (21000, CA21000, 24701, or CA24701 option D) and 046 | Housing AAA options for 3300 NSv probe options (A:26, A:27, A:31, or A:32) Example Original part number 24701-31-10-15-090-03-02 AAA option for replacement sleeve (015 + 090 + 046) = 151 |
| Standoff Adapter Option from original housing (21000, CA21000, 24701, or CA24701 option C) plus Probe penetration option from original housing (21000, CA21000, 24701, or CA24701 option D) and 037 | Housing AAA options for 3300 XL 11mm probe options (A:29, A:30, A:35, or A:36) Example Original part number CA24701-36-10-40-053-02-02 AAA option for replacement sleeve (040 + 053 + 037) = 130 |

| AAA | Description |
|--|---|
| Standoff Adapter Option from original housing (21000, CA21000, 24701, or CA24701 option C) plus Probe penetration option from original housing (21000, CA21000, 24701, or CA24701 option D) and 039 | Housing AAA options for 7200 Series 11mm probe options (A:06 or A:12) Example Original part number CA24701-12-10-30-113-01-02 AAA option for replacement sleeve (030 + 113 + 039) = 182 |
| Minimum Probe Sleeve Length | |
| For all probes except NSv and 11mm probes | 5.5 in (140 mm) = 055 |
| 3300 XL NSv probe | 5.5 in (142 mm) = 056 |
| 3300 XL 11mm probe | 4.7 in (119 mm) = 047 |
| Maximum Probe Sleeve Length | |
| All 0.5 meter probes except NSv and 11mm probes | 18.0 in (457 mm) = 180 |
| 3300 XL NSv 0.5 meter probe | 18.1 in (460 mm) = 181 |
| 7200-series 0.5 meter 11mm probe | 15.4 in (391 mm) = 154 |
| All 1.0 meter probes except NSv and 11mm probes | 33.7 in (856 mm) = 337 |
| 3300 XL NSv 1.0 meter probe | 33.8 in (859 mm) = 338 |
| 3300 XL 1.0 meter 11mm probe | 32.9 in (836 mm) = 329 |
| 7200 Series 1.0 meter 11mm probe | 33.1 in (841 mm) = 331 |

Individual Standoff Adapter 21003-AAA

A: Individual Standoff Adapter

| | |
|----------------|---|
| 015 | Minimum length 1.5 in (38 mm) |
| 075 | Maximum length 7.5 in (191 mm) |
| Recommendation | Order in increments of 0.5 in (13 mm) 4.5 in (114 mm) = 045 |

| | |
|-----------|---|
| Example 1 | <p>For desired probe penetration lengths of less than 25 mm (1.0 in), order a separate Individual Standoff Adapter.</p> <p>The effective probe penetration length will then be reduced by the length of the Individual Standoff Adapter, plus an additional 13 mm (0.5 in) due to the NPT thread engagement.</p> |
|-----------|---|

Example 2

To create a probe penetration length 13 mm (0.5 in), order a 21000 housing with DDD (probe penetration) option of 030 [76 mm (3 in)] and a separate individual standoff adapter that is 51 mm (2.0 in) in length (part number 21003-020).

The standoff adapter covers 38 mm (2.0 in) of the probe sleeve **plus** an additional 13 mm (0.5 in).

Therefore, the effective probe penetration length drops to 13 mm (0.5 in).

 If you use effective penetration lengths of less than 1.0 inches, signal effects are likely due to probe side view or rear view of metal components.

Spare 3300 XL 8mm Reverse Mount Probe, 3/8-24 UNF threads 330105-02-12-CC-DD-EE

A: Total Length

| | |
|-----------|-----------------------|
| 05 | 0.5 meter (1.6 feet) |
| 10 | 1.0 meter (3.3 feet) |
| 15 | 1.5 meter (4.9 feet) |
| 20 | 2.0 meter (6.6 feet) |
| 50 | 5.0 meter (16.4 feet) |
| 90 | 9.0 meter (29.5 feet) |

B: Connector

| | |
|-----------|--------------------------------------|
| 00 | Connector not installed |
| 02 | Miniature ClickLoc coaxial connector |

Agency Approval

| | |
|-----------|--------------------|
| 00 | Not required |
| 05 | Multiple approvals |

**Spare 3300 NSv Reverse Mount
 Probe, 3/8-24 UNF threads**

330906-02-12-CC-DD-EE

C: Total Length

| | |
|-----------|-----------------------|
| 05 | 0.5 meter (1.6 feet) |
| 10 | 1.0 meter (3.3 feet) |
| 50 | 5.0 meter (16.4 feet) |
| 70 | 7.0 meter (23.0 feet) |

D: Connector

| | |
|-----------|--------------------------------------|
| 00 | Connector not installed |
| 02 | Miniature ClickLoc coaxial connector |

E: Agency Approval

| | |
|-----------|--------------------|
| 00 | Not required |
| 05 | Multiple approvals |

| | |
|-----------|---------------------------------------|
| 00 | Without connector |
| 02 | With miniature male coaxial connector |

E: Agency Approval

| | |
|-----------|--------------------|
| 00 | Not required |
| 05 | Multiple approvals |

**Spare 3300 XL 11mm Reverse Mount
 Probe, 3/8-24 UNF threads**

330705-02-18-CC-DD-EE

C: Total Length

| | |
|-----------|-----------------------|
| 10 | 0.5 meter (1.6 feet) |
| 50 | 5.0 meter (16.4 feet) |
| 90 | 9.0 meter (29.5 feet) |

D: Connector

Graphs and Figures

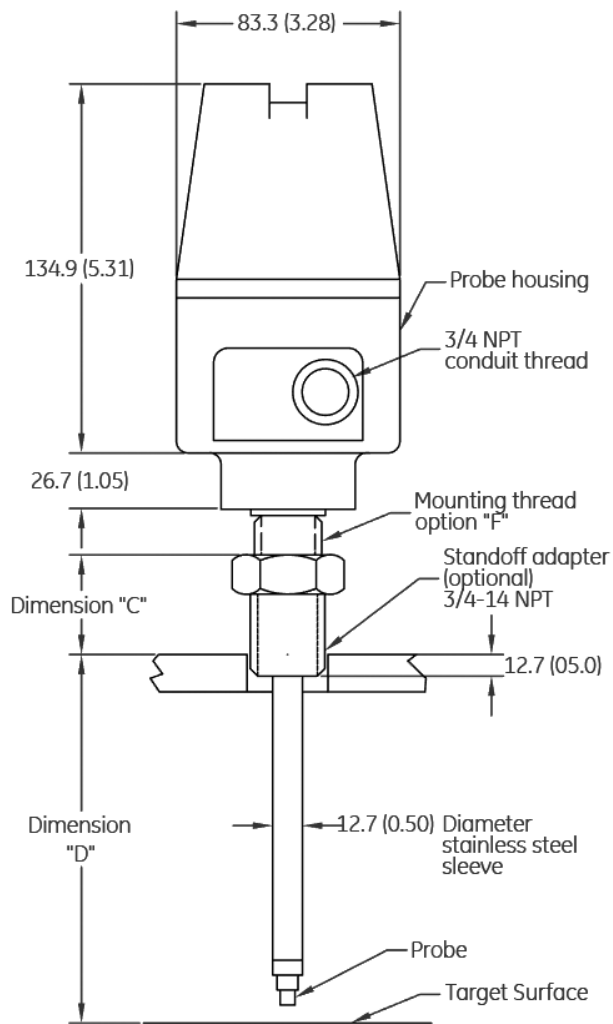

| Probe Cable Length | Maximum (C) + (D) with visible probe (P/N and S/N) | Maximum (C) + (D) Dimension |
|--------------------|--|-----------------------------|
| 12 in | Not visible | 5.0 in (12.7 cm) |
| 18 in | 4.0 in (10.1 cm) | 10.5 in (26.6 cm) |
| 24 in | 9.7 in (24.6 cm) | 16.1 in (40.9 cm) |
| 30 in | 15.4 in (39.1 cm) | 21.7 in (51.1 cm) |
| 36 in | 21.1 in (53.6 cm) | 27.3 in (69.3 cm) |
| 0.5 m | Not visible | 13.5 in (34.3 cm) |
| 1.0 m | 17.0 in (43.18 cm) | 32.9 in (83.5 cm) |

Figure 1: 21000/CA21000 Proximity Probe Housing Assembly

Dimensions are in millimeters (inches).

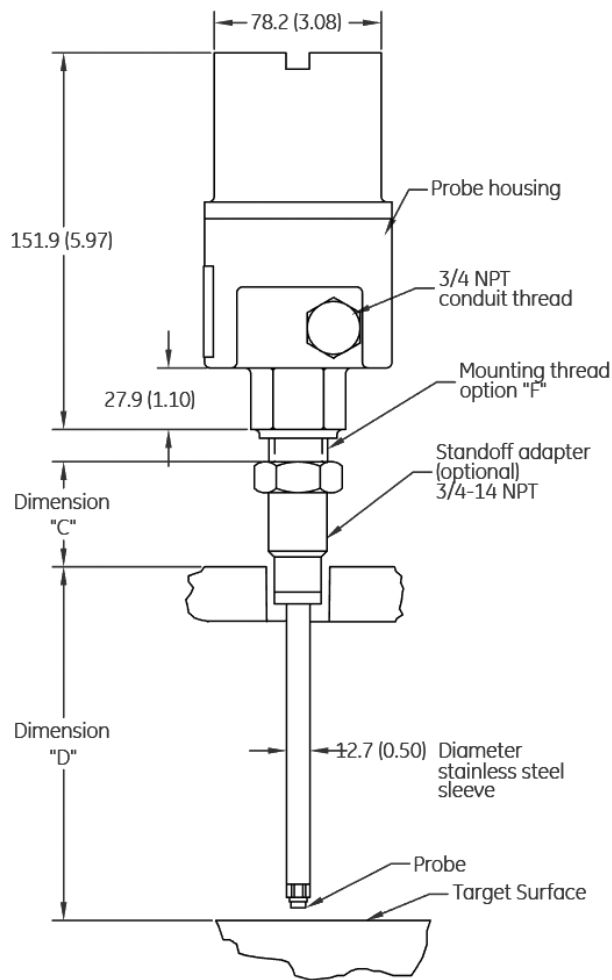

24701/CA24701 Dimensions

| Probe Cable Length | Maximum (C) + (D) with visible probe (P/N and S/N) | Maximum (C) + (D) Dimension |
|--------------------|--|-----------------------------|
| 12 in | Not visible | 5.0 in (12.7 mm) |
| 18 in | 4.0 in (10.1 cm) | 10.5 in (26.6 mm) |
| 24 in | 9.7 in (24.6 cm) | 16.1 in (40.9 mm) |
| 30 in | 15.4 in (39.1 mm) | 21.7 in (51.1 mm) |
| 36 in | 21.1 in (53.6 mm) | 27.3 in (69.3 mm) |
| 0.5 m | Not visible | 13.5 in (34.3 mm) |
| 1.0 m | 17.0 in (43.18 mm) | 29.2 in (74.2 mm) |

Figure 2: 24701/CA24701 Proximity Probe Housing Assembly

Dimensions are in millimeters (inches).

Tables

Table 1: For Figure 1, Dimensions in mm (inches).

| Catalog Number | Dimension | | | |
|----------------|-------------|--------------|---------------------------|-------------|
| | A | B | C and D | E |
| 21000 | 83.3 (3.28) | 161.6 (6.36) | See Ordering Option C & D | 26.7 (1.05) |
| 24701 | 78.2 (3.08) | 151.9 (5.97) | See Ordering Option C & D | 27.9 (1.10) |

Table 2: Maximum Length of C and D Dimension for Proximity Probes

| Probe Cable Length | Maximum C and D Dimension |
|-------------------------|---------------------------|
| 0.5 meter (3300 Series) | 343 mm (13.5 in) |
| 1.0 meter | 742 mm (29.2 in) |

Table 3: Maximum C and Dimension with Standard P/N and S/N Label (non-flag label)

| Probe Cable Length | Maximum C and D Dimension |
|--------------------|---------------------------|
| 0.5 meter | Not visible |
| 1.0 meter | 432 mm (17 m) |

Copyright 2023 Baker Hughes Company. All rights reserved.



Bently Nevada, M2, Proximitor and Orbit Logo are registered trademarks of Bently Nevada, a Baker Hughes business, in the United States and other countries. The Baker Hughes logo is a trademark of Baker Hughes Company. All other product and company names are trademarks of their respective holders. Use of the trademarks does not imply any affiliation with or endorsement by the respective holders.

Baker Hughes provides this information on an "as is" basis for general information purposes. Baker Hughes does not make any representation as to the accuracy or completeness of the information and makes no warranties of any kind, specific, implied or oral, to the fullest extent permissible by law, including those of merchantability and fitness for a particular purpose or use. Baker Hughes hereby disclaims any and all liability for any direct, indirect, consequential or special damages, claims for lost profits, or third party claims arising from the use of the information, whether a claim is asserted in contract, tort, or otherwise. Baker Hughes reserves the right to make changes in specifications and features shown herein, or discontinue the product described at any time without notice or obligation. Contact your Baker Hughes representative for the most current information.

The information contained in this document is the property of Baker Hughes and its affiliates; and is subject to change without prior notice. It is being supplied as a service to our customers and may not be altered or its content repackaged without the express written consent of Baker Hughes. This product or associated products may be covered by one or more patents. See [Bentley.com/legal](https://www.bentley.com/legal).

1631 Bently Parkway South, Minden, Nevada USA 89423
Phone: 1.775.782.3611 (US) or [Bentley.com/support](https://www.bentley.com/support)
[Bentley.com](https://www.bentley.com)